

ID-Nr. 30472-005
Model UB90.060.059.S



safety storage under bench cabinet UB-S-90
Model UB90.060.059.S, laboratory white (sim. RAL 9016)

Safe and approved storage of flammable hazardous substances in working areas

Function / construction:

- **Robust construction and longevity:** body made of powder-coated sheet steel
- **Mobile:** castors with plinth (optionally available), easy moving of the cabinet
- **Ventilation:** integrated air ducts ready for connection (DN 50) to a technical exhaust system

Dimensions	
Width (external)	593.00 mm
Depth (external)	574.00 mm
Height (external)	600.00 mm
Width (internal)	470.00 mm
Depth (internal)	452.00 mm
Height (internal)	502.00 mm

The available internal dimensions can vary depending on the interior equipment package.

Weight / Load	
Weight without interior equipment	120 kg
Distributed load	450.00 kg/m ²
Maximum load	300 kg

Ventilation	
Extraction air	50 DN
Minimum exhaust air quantity 10 times	1 m ³ /h
Differential pressure (10 times air change)	1 Pa

Colouring / Surface finish	
Body colour code	
Body colour	laboratory white (sim. RAL 9016)
Body surface finish	plain
Door / Drawer colour code	
Door / Drawer colour	laboratory white (sim. RAL 9016)
Door / Drawer surface finish	plain

General Information	
Number of drawers	1
Capacity of drawer	11.50 litres
Customs tariff number	94032080

Front view

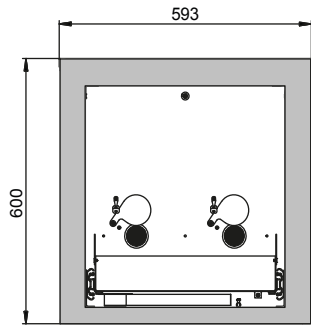

Side view

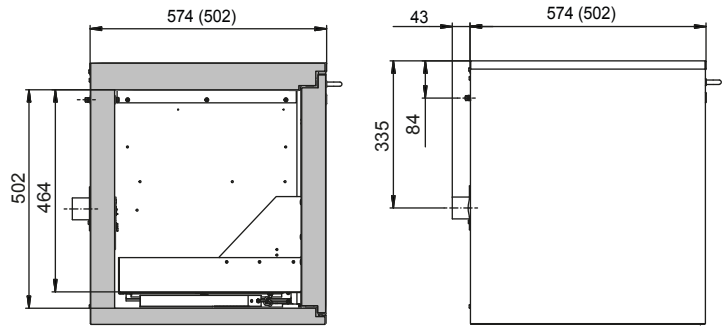

Top view

