

Pick Your Match

PCR Consumables from Eppendorf



»Professionalism requires versatility— especially in thinking.«

Eppendorf PCR Consumables

Every researcher doing PCR always wonders about the best instrument, the best master mix, the best polymerase etc. Also when it comes to choosing the plastic consumables that build the connection between PCR instruments and your precious sample, the same rationality and prudence should be applied.

Different consumables can make a huge difference in the quality and reproducibility of your PCR results.

Wall-thickness, thermal conductivity of the material, mechanical stability and many other technical characteristics will have a direct impact on your experiment and subsequently the results. Make sure you use the best PCR consumables for your application!

Plates

The Eppendorf twin.tec® PCR Plates are available in different versions: from fully skirted plates to optimize automation and barcoding to unskirted plates for optimal fit with many different cyclers. Additionally, a 384 well version is available in the same brilliant colors.



Tubes

Since 1963, when Eppendorf invented the microcentrifuge tube, Eppendorf tubes® have shown to be reliable companions of utmost quality for your daily work. The thin-walled Eppendorf PCR Tubes are easy to open but provide tight sealing for the PCR.

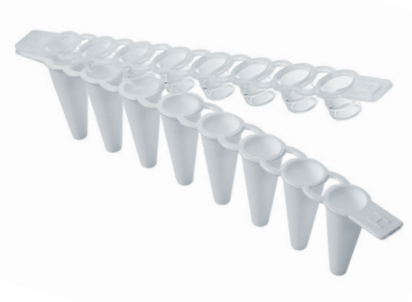

Sealing

Heat sealing, adhesive sealing, Cap Strips: you name it—we got it. Especially our smart qPCR sealing solutions with high light transmission rates or inverted domes give you a distinct advantage for your assay. Convenient packaging makes your daily work easy and safe.



Great Variety

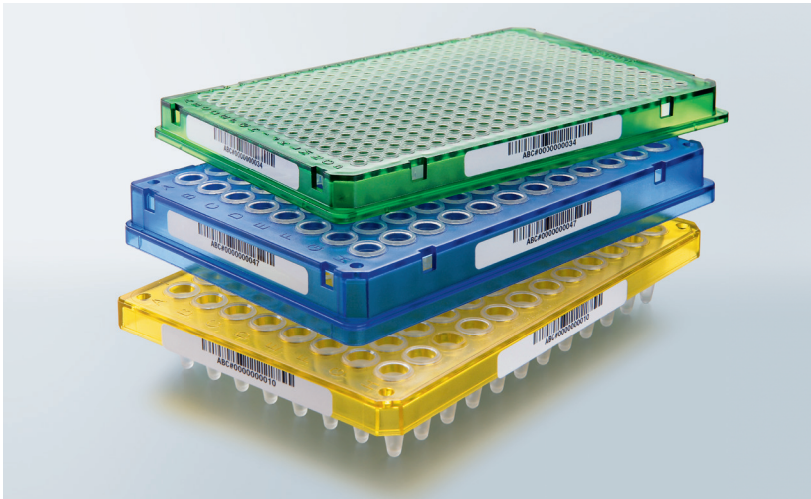

twin.tec PCR Plate 96, skirted

- > Compatible with automated systems
- > Skirted for label or barcode
- > Within SBS footprint recommendations (127.76 × 85.47 mm ± 0.25 mm)
- > Stackable
- > Low profile design enables low volume PCR
- > 150 µL max. well volume (when used with cap strips)



twin.tec PCR Plate 96, semi-skirted

- > Semi-skirted for label and barcode
- > Fits most thermal cyclers
- > 250 µL max. well volume (when used with cap strips)



twin.tec PCR Plate 96, unskirted

- > Fits even more thermal cyclers
- > OptiTrack® matrix: high contrast labelling of alphanumeric grid
- > Available with regular (250 µL) or low profile (150 µL) wells

twin.tec PCR Plate 96, unskirted divisible

- > Can be divided in 4 segments of 24 wells each
- > Fits most common thermal cyclers
- > OptiTrack® matrix: high contrast labelling of alphanumeric grid
- > Available with regular (250 µL) or low profile (150 µL) wells

twin.tec microbiology PCR Plate

- > Sterile, individually blistered
- > Certified PCR clean
- > Additionally free of bacterial DNA
- > For all applications that need ultimate purity or certified absence of bacterial DNA

twin.tec PCR Plate 384

- > Skirt optimized for automation and barcoding
- > Eight holes in the skirt aid plate positioning and removal from the thermal cycler block, e.g. with grippers
- > Stackable
- > Within SBS footprint recommendations
- > Ideal for most common 384-well thermocyclers, particularly for Eppendorf Mastercycler® pro 384
- > 45 µL max. well volume

> NEW: twin.tec PCR Plate 96, LoBind

- > Available in skirted and semi-skirted format
- > LoBind surface can provide better sensitivity
- > LoBind surface can improve results of low concentration PCR
- > All other benefits as regular skirted or semi-skirted plates

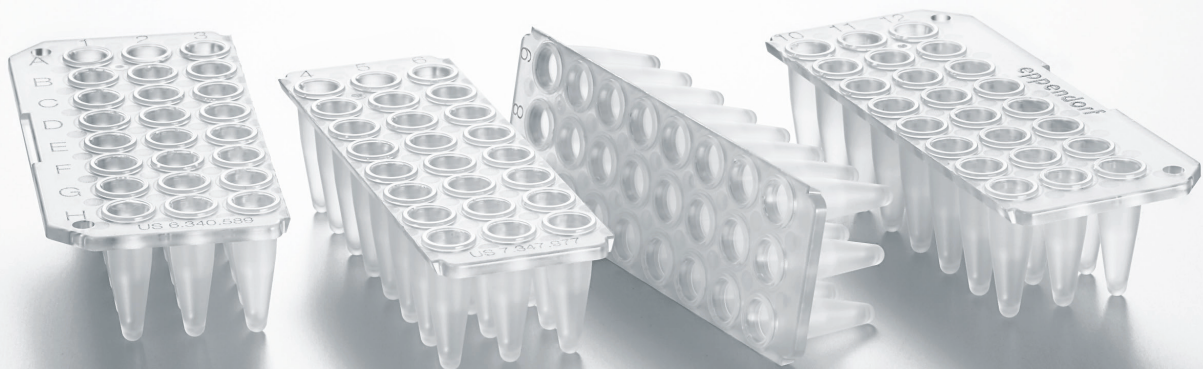

The Bright Choice

twin.tec *real-time* PCR Plates

On top of the rigidity of the polycarbonate frame and the excellent heat transfer of polypropylene wells, Eppendorf twin.tec® *real-time* PCR Plates give you the advantage of white wells for your real-time PCR.

The limiting factor in low volume real-time PCR is often the remaining intensity of fluorescence. The white wells of the Eppendorf twin.tec® *real-time* PCR Plates reflect fluorescence much better than clear or frosted wells.

Thus, lower levels of fluorescence are still detectable. Additionally, white wells reduce interfering background fluorescence and lead to increased homogeneity of replicates and reproducible results.

Product features of twin.tec *real-time* PCR Plates

- > White wells for better reflection
- > High mechanical stability
- > Raised rims for effective sealing
- > »Skirted« (stackable) and »semi-skirted« plates
- > Optimal heat transfer due to reduced wall thickness
- > Autoclavable (121 °C, 20 min.)

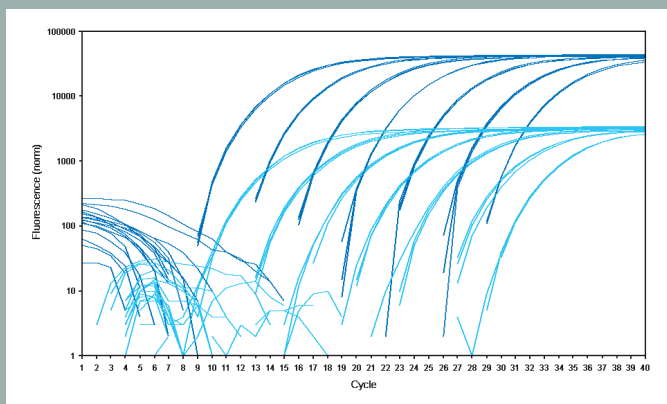

The intensity of fluorescence measured by the instrument is up to 10-fold higher than with frosted wells.

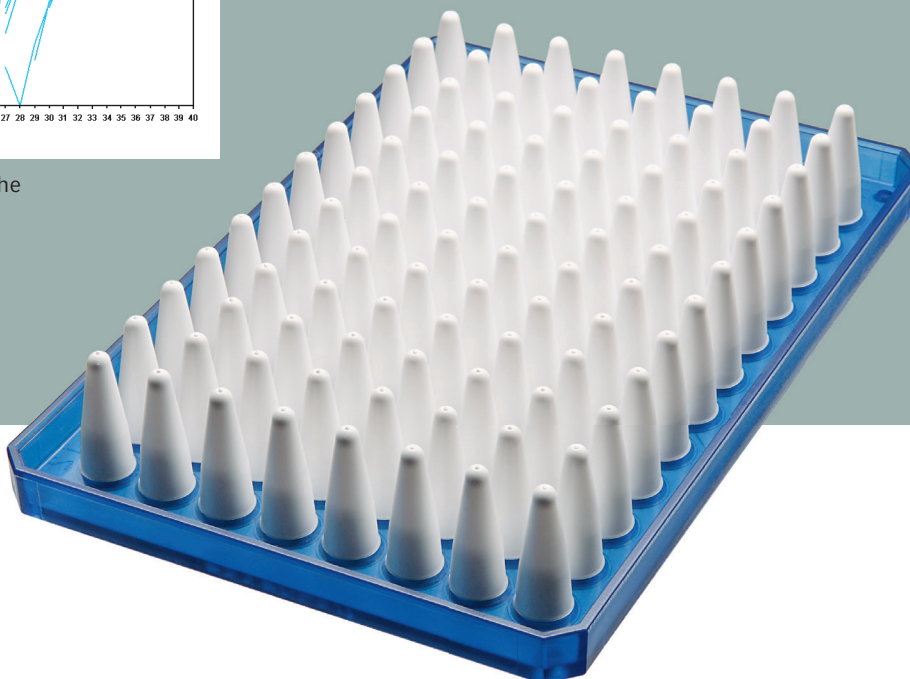

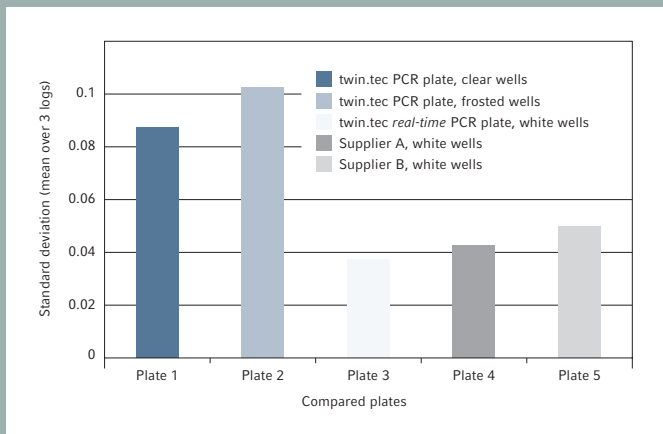

The standard deviation of replicates is lower than with other plates.

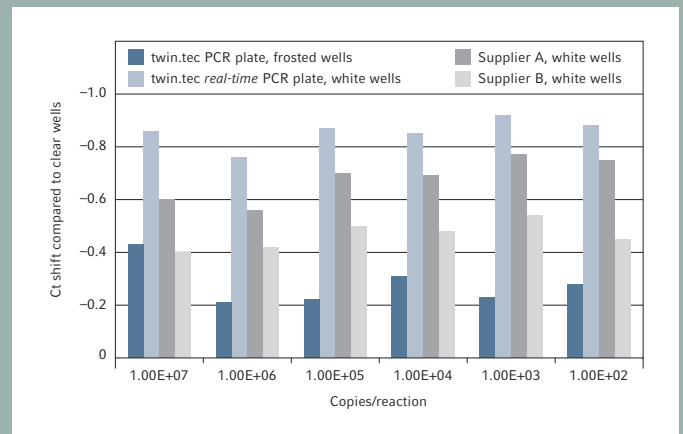

C_t -values are reduced more effectively than with other plates. In average C_t -values are 0.8 cycles earlier (compared to clear wells), indicating better sensitivity.



The Original Tube

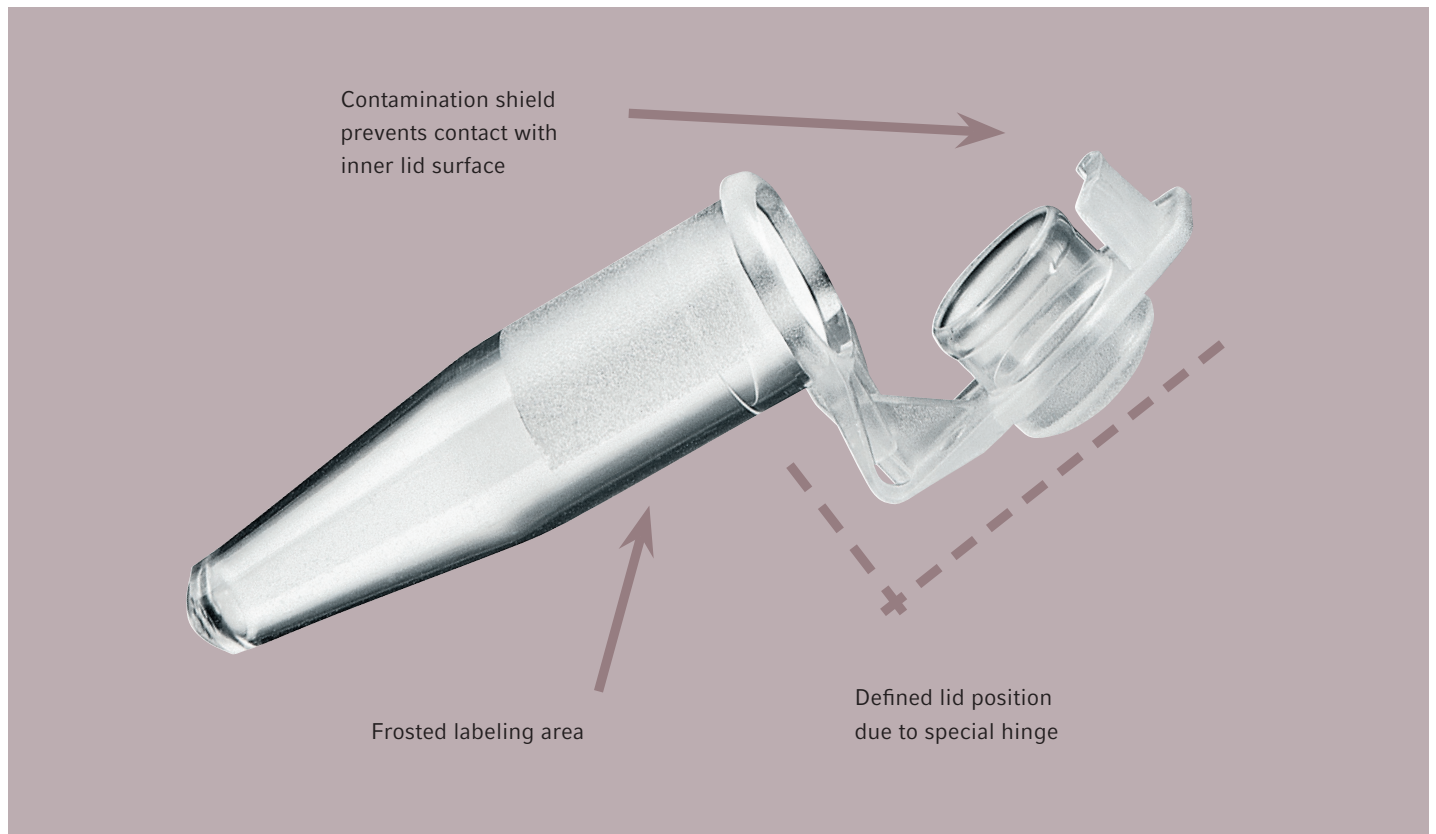

Eppendorf PCR Tubes

These thin-walled polypropylene tubes ensure efficient and homogenous heat transfer to the sample, thanks to their even wall thickness and smooth wall surface. The tubes come in a heat-sealed bag to ensure the highest degree of purity.

Product features of 0.5 mL PCR Tubes, thin-walled

- > More space for labeling due to improved lid design
- > Frosted labeling area
- > Etched lid for labeling
- > Tight sealing, but easy to open
- > For use with all thermal cyclers with 0.5 mL block format
- > Certified free from human DNA, DNase, RNase and PCR inhibitors*¹

Product features of 0.2 mL PCR Tubes, thin-walled

- > Contamination shield on hinged lid
- > Defined lid position due to special hinge
- > Etched lid for labeling
- > Tight sealing, but easy to open
- > For use with all thermal cyclers with 0.2 mL block format
- > Certified free from human DNA, DNase, RNase and PCR inhibitors*¹

*¹ Certificate, test procedures and detailed information on request.

Brilliant Views

Transmission values for Eppendorf Masterclear® Cap Strips and competitor products

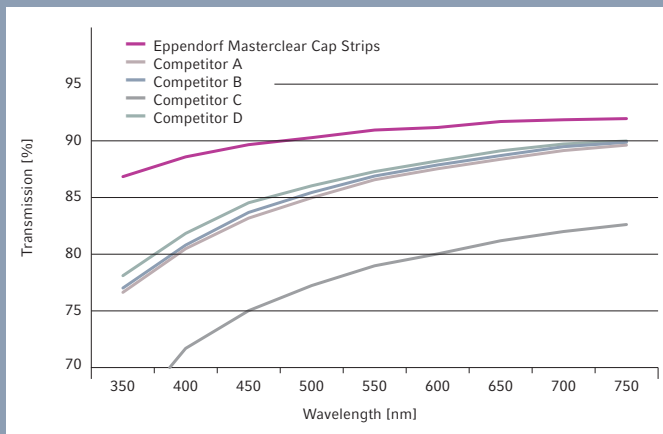

Transmission real-time PCR Cap Strips



real-time PCR Tube Strips

Masterclear® Cap Strips and real-time PCR Tube Strips

Eppendorf *real-time* PCR Tube Strips feature an extremely thin wall for optimal heat transfer combined with high mechanical stability. In combination with their optical properties these are the ideal tube strips for real-time PCR, especially for use with small reaction volumes.

The inverted dome of the Masterclear® Cap Strips prevents scratching or contamination of the optical surface and reduces the volume of the micro test tube.

Masterclear® Cap Strips

- > Inverted Dome prevents scratching of the optical surface
- > Inverted Dome reduces tube volume
- > Optimized for optimum light transmission

real-time PCR Tube Strips

- > White wells with improved reflection
- > High mechanical stability
- > Extremely thin walls for optimum heat transfer
- > 150 µL maximum volume

Cap Strips

- > Strips with eight microcaps for 0.1 mL and 0.2 mL wells
- > Easy and rapid sealing of PCR plates
- > Easy to remove using tab at end of strip
- > Autoclavable (121 °C, 20 min)
- > With flat or domed shape



Cap Strips

Sealing is Believing

Masterclear® *real-time* PCR Film, adhesive

Seal your real-time PCR plates tight with this optical adhesive film. Transmission values of >90 % between 350 nm and 750 nm guarantee optimal excitation of your fluorescent dyes and optimal read-out of the emitted fluorescence.

Product features of Masterclear® *real-time* PCR Film

- > Optimized for maximum transmission
- > Optimized for tight sealing
- > Optimized packaging for your convenience

Product features of PCR Film (adhesive) and PCR Foil (adhesive)

- > Removal from the plate with no residue
- > Autoclavable (121 °C, 20 min)

PCR Film:

- > Sample monitoring through the transparent film

PCR Foil:

- > Easily pierced
- > No sticking of the pipette tip (ideal for automated systems)



Technical specifications

Description	Heat Sealing PCR Film	Heat Sealing PCR Foil
Packaging unit	1 × 100 pcs.	1 × 100 pcs.
Features	<ul style="list-style-type: none"> > Optically clear polyester/polypropylene laminate > Extremely stable sealing option — cannot be removed or pierced 	<ul style="list-style-type: none"> > Laminated aluminium foil > Easily pierced — even with multichannel pipettes > Easily removable
Seal integrity	–80 °C to 100 °C	–80 °C to 100 °C
Sealing time with Eppendorf Heat Sealer	4 sec.	4 sec.
Weldable materials	Polypropylene	Polypropylene
Special applications	<ul style="list-style-type: none"> > Colorimetric applications > Fluorescence applications, including real-time PCR > Storage of hazardous samples 	<ul style="list-style-type: none"> > Recommended for use in automated systems

The Famous Rack Pack

PCR Rack

- > Rack for handling and storing tubes and plates
- > For 0.1 mL to 0.5 mL tubes, as well as 96-well plates
- > Stackable
- > Can be stored down to $-90\text{ }^{\circ}\text{C}$
- > Autoclavable ($121\text{ }^{\circ}\text{C}$, 20 min)

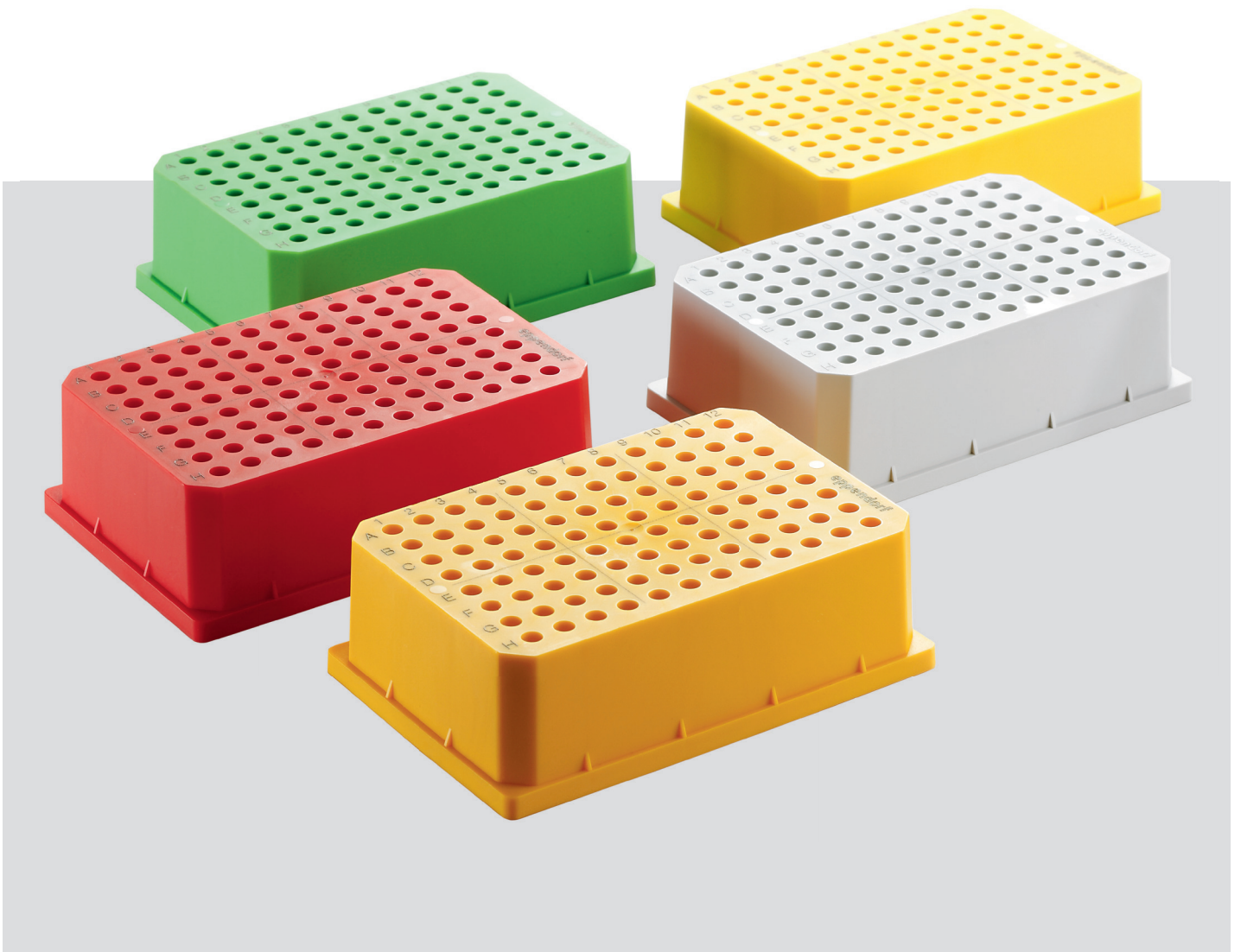

Only the Best

Every researcher doing PCR always wonders about the best instrument, the best master mix, the best polymerase etc. Also when it comes to choosing the plastic consumables that build the connection between PCR instruments and your precious sample, the same rationality and prudence should be applied.

Different consumables can make a huge difference in the quality and reproducibility of your PCR results. Wallthickness, thermal conductivity of the material, mechanical stability and many other technical characteristics will have a direct impact on your experiment and subsequently the results.

Since 1963, when Eppendorf invented the microcentrifuge tube, Eppendorf consumables have proven themselves in daily lab routines around the world. The increasing complexity of analytical techniques over the years means however that today's Eppendorf consumables must fulfill higher demands than ever before.

Best quality

- > All Eppendorf consumables are made of high grade, virgin polypropylene (PP)
- > The dyes used for our consumables are free of organic additives and heavy metals
- > Constant testing and development guarantee continuous improvement and innovation.
- > Eppendorf's purity grade »PCR clean« certifies that the product is free from detectable human DNA,
- > DNase, RNase and PCR inhibitors*¹

*1: Certificate, test procedure and detailed information available upon request.



German Quality

Eppendorf twin.tec® PCR Plates

If you think a PCR plate is just a PCR plate, you will be surprised to see how much the twin.tec PCR Plate from Eppendorf can offer you:

- > Extremely thin-walled polypropylene wells for optimal heat transfer to the sample
- > Extremely robust polycarbonate frames for ultimate rigidity and torque-resistance
- > Raised well rims for effective sealing, also reduces the risk of cross-contamination
- > Autoclavable (121 °C, 20 min)
- > Certified to be free of any detectable human DNA, DNase, RNase and PCR inhibitors*¹
- > Also available with individual barcode (not for unskirted plates)

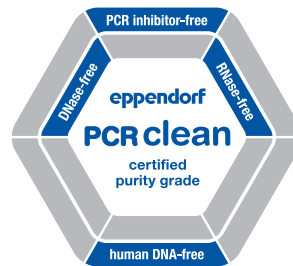

*¹: Certificate, test procedures and detailed information on request.

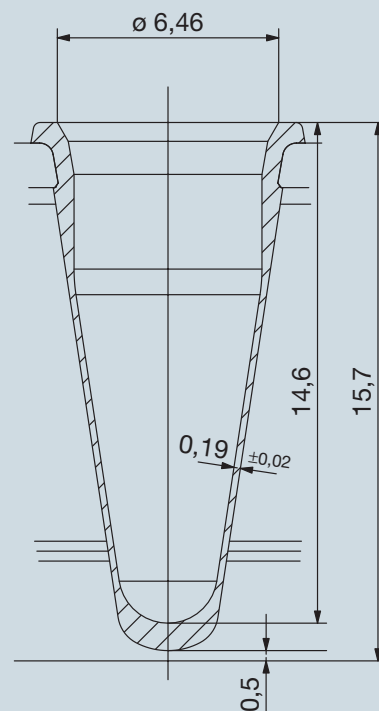
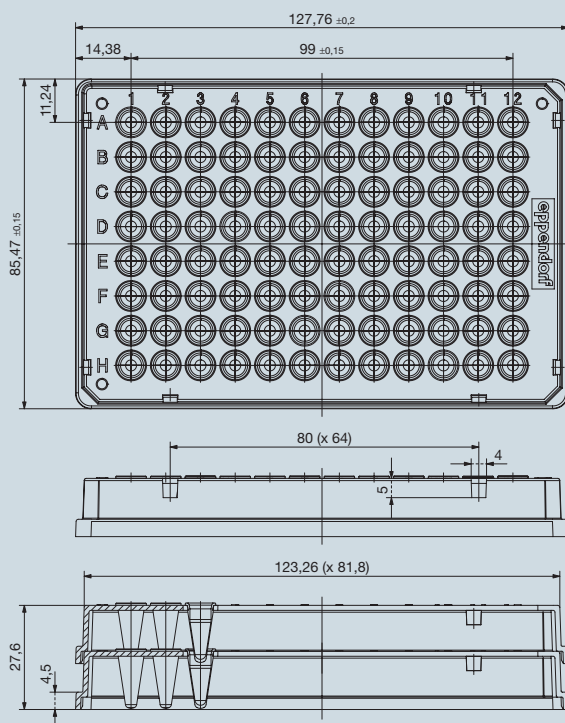

Ordering information

Description	International Order no.	North America Order no.
twin.tec PCR Plate 96, skirted, 25 pcs.		
Clear	0030 128.648	951020401
Yellow	0030 128.656	951020427
Green	0030 128.664	951020443
Blue	0030 128.672	951020460
Red	0030 128.680	951020486
twin.tec PCR Plate 96, semi-skirted, 25 pcs.		
Clear	0030 128.575	951020303
Yellow	0030 128.583	951020320
Green	0030 128.591	951020346
Blue	0030 128.605	951020362
Red	0030 128.613	951020389
twin.tec PCR Plate 96, unskirted low profile, 20 pcs.		
Clear	0030 133.307	0030133307
Yellow	0030 133.315	0030133315
Green	0030 133.323	0030133323
Blue	0030 133.331	0030133331
Red	0030 133.340	0030133340
Clear (divisible)	0030 133.358	0030133358
Blue (divisible)	0030 133.382	0030133382
twin.tec PCR Plate 96, unskirted (250 µL), 20 pcs.		
Clear	0030 133.366	0030133366
Blue	0030 133.390	0030133390
Clear (divisible)	0030 133.374	0030133374
Blue (divisible)	0030 133.404	0030133404
twin.tec microbiology PCR Plate 96, skirted, 10 pcs.		
Clear	0030 129.300	0030129300
Blue	0030 129.318	0030129318
twin.tec microbiology PCR Plate 96, semi-skirted, 10 pcs.		
Clear	0030 129.326	0030129326
Blue	0030 129.334	0030129334
twin.tec microbiology PCR Plate 384, 10 pcs.		
Clear	0030 129.342	0030129342
Blue	0030 129.350	0030129350
twin.tec PCR Plate 384, 25 pcs.		
Clear	0030 128.508	951020702
Yellow	0030 128.516	951020711
Green	0030 128.524	951020729
Blue	0030 128.532	951020737
Red	0030 128.540	951020745
twin.tec PCR Plate 96, skirted, LoBind		
Clear	0030 129.512	0030129512
twin.tec PCR Plate 96, semi-skirted, LoBind		
Clear	0030 129.504	0030129504

*1 Eppendorf owns IP rights under European Patent EP 1 161 994 and US patents US 7,347,977 and US 6,340,589

Ordering information

Description	International Order no.	North America Order no.
twin.tec real-time PCR Plate 96, skirted, 25 pcs.		
White	0030 132.513	951022015
Blue	0030 132.505	951022003
Black	0030 132.521	951022027
twin.tec real-time PCR Plate 96, semi-skirted, 25 pcs.		
White	0030 132.548	951022055
Blue	0030 132.530	951022043
Black	0030 132.556	951022067
twin.tec real-time PCR Plate 96, unskirted low profile, 20 pcs.		
White	0030 132.700	0030132700
Blue	0030 132.718	0030132718
Black	0030 132.726	0030132726
twin.tec 384 real-time PCR Plates, skirted, 25 pcs.		
White	0030 132.734	0030132734
Blue	0030 132.742	0030132742
Black	0030 132.750	0030132750
Eppendorf PCR Tubes		
0.2 mL PCR Tubes, thin-walled with hinged lid (1000 tubes)	0030 124.332	951010006
0.5 mL PCR Tubes, thin-walled with lid (500 tubes)	0030 124.537	0030124537
8-tube strip, for 0.2 mL PCR Tubes (10 × 12 pieces)	0030 124.359	951010022
PCR Tube Strips 0.1 mL, without caps (10 × 12 pieces)	0030 124.804	0030124804
PCR Tube Strips 0.1 mL + Cap Strips, domed (10 × 12 pieces each)	0030 124.812	0030124812
PCR Tube Strips 0.1 mL + Cap Strips, flat (10 × 12 pieces each)	0030 124.820	0030124820
Cap Strips, domed (8-strips), 10 × 12 pcs.	0030 124.839	0030124839
Cap Strips, flat (8-strips), 10 × 12 pcs.	0030 124.847	0030124847
Masterclear® Cap Strips, (10 × 12 pieces)	0030 132.874	951022089
real-time PCR Tube Strips without caps (10 × 12 pieces)	0030 132.882	951022102
Masterclear® Cap Strips and real-time PCR Tube Strips (10 × 12 pieces each)	0030 132.890	951022109
PCR Rack		
PCR Rack, 10 pcs.	0030 124.545	0030124545
Sealing Materials		
Masterclear® real-time PCR Film adhesive, 100 sheets	0030 132.947	951022115
Heat Sealing PCR Film, 100 pcs.	0030 127.838	0030127838
Heat Sealing PCR Foil, 100 pcs.	0030 127.854	0030127854
PCR Film (adhesive), 100 pcs.	0030 127.781	0030127781
PCR Foil (adhesive), 100 pcs.	0030 127.790	0030127790

Your local distributor: www.eppendorf.com/contact

Eppendorf AG · 22331 Hamburg · Germany
eppendorf@eppendorf.com · www.eppendorf.com
Eppendorf North America, Inc. · Phone: 800-645-3050
info@eppendorf.com · www.eppendorfna.com
Eppendorf Canada Ltd. · Phone: 800-263-8715
canada@eppendorf.com · www.eppendorf.ca

www.eppendorf.com