

HI 84532 TITRATABLE ACIDITY MINITITRATOR & pH METER for Fruit Juice

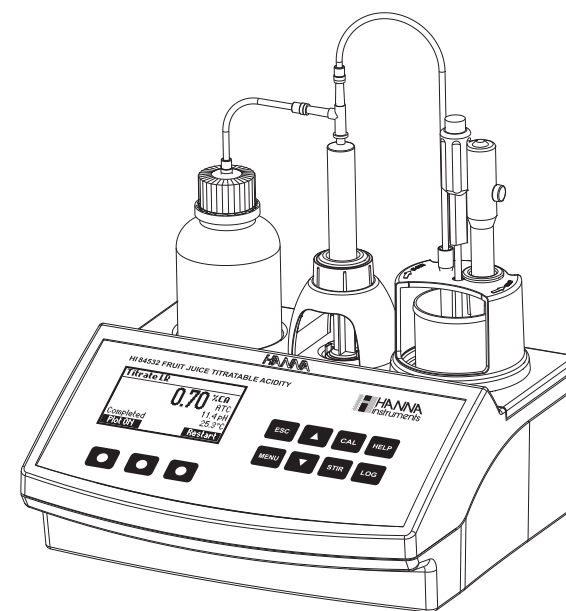

Dear Customer,

Thank you for choosing a Hanna Instruments product.

Please read this instruction manual carefully before using this instrument. This manual will provide you with the necessary information for correct use of the instrument, as well as a precise idea of its versatility.

If you need additional technical information, do not hesitate to e-mail us at tech@hannainst.com or view our worldwide contact list at www.hannainst.com.

TABLE OF CONTENTS

| | |
|--|----|
| PRELIMINARY EXAMINATION | 4 |
| GENERAL DESCRIPTION | 5 |
| SPECIFICATIONS | 7 |
| PRINCIPLE OF OPERATION | 8 |
| FUNCTIONAL DESCRIPTION | 9 |
| TITRATOR STARTUP | 11 |
| SETUP MENU | 12 |
| GUIDE TO DISPLAY CODES | 16 |
| ELECTRODE PREPARATION | 19 |
| ELECTRODE CALIBRATION PROCEDURE | 20 |
| pH BUFFER TEMPERATURE DEPENDENCE | 24 |
| DOSING PUMP INSTALLATION | 25 |
| DOSING PUMP PRIME PROCEDURE | 25 |
| PUMP CALIBRATION PROCEDURE | 27 |
| TITRATION PROCEDURE | 29 |
| pH MEASUREMENT | 34 |
| PC INTERFACE AND DATA TRANSFER | 38 |
| TROUBLESHOOTING GUIDE | 39 |
| ELECTRODE CONDITIONING AND MAINTENANCE | 41 |
| ACCESSORIES | 42 |
| WARRANTY | 43 |

All rights are reserved. Reproduction in whole or in part is prohibited without the written consent of the copyright owner, Hanna Instruments Inc., Woonsocket, Rhode Island, 02895, USA.

PRELIMINARY EXAMINATION

Please examine this product carefully. Make sure that the instrument is not damaged. If any damage occurred during shipment, please notify your Dealer.

Each **HI 84532** minititrator is supplied complete with:

- **HI 84532-70** Reagent Kit for titratable acidity in fruit juice
- **HI 1131B** pH electrode
- **HI 7662-T** Temperature probe
- **HI 7082** Electrode Fill Solution (30 mL)
- Two 100 mL beakers
- One 20 mL beaker
- Tube set (aspiration tube with titrant bottle cap and dispensing tube with tip)
- Dosing Pump Valve
- 5 mL Syringe
- 1 mL Plastic Pipette
- Stir bar
- Power adapter
- Instruction manual

Note: Save all packing material until you are sure that the instrument works correctly. Any defective item must be returned in its original packing.

GENERAL DESCRIPTION

The **HI 84532** is a low-cost, easy to use microprocessor-based automatic minititrator and pH meter designed for the rapid and accurate analysis of Total Titratable Acidity in fruit juice. The **HI 84532** minititrator is a valuable tool because of its ability to eliminate subjective factors including color indicators, errors in mathematical calculations or erratic titrant additions from the measurement, it will quickly become a valuable acidity analysis tool of fruit juice.

The instrument benefits from Hanna's many years of experience as a manufacturer of quality analytical instruments. A clear and well-designed user interface makes the instrument intuitive and easy to use.

The instrument employs a powerful and effective built-in algorithm to analyze the pH response to determine the exact endpoint, then uses this to perform the necessary calculations.

By pressing the **Start** key in **Titration** mode, the instrument will automatically titrate the sample to the end point. The results are immediately displayed in the selected unit, then the instrument is ready for another titration by pressing the **Restart** key.

A dedicated **HELP** key aids in setup, calibration, status and troubleshooting.

Other features:

- pH meter / mV meter
- Stir speed control
- Graphic mode to display the titration data
- Data can be stored using the log feature and then exported to a USB stick or transferred to a PC using the USB connection
- Log on demand for up to 400 samples (200 for mV/pH measurements; 200 for titration results)
- GLP feature, to view calibration data for pH electrode and pump

SIGNIFICANCE OF USE

Titrate acidity is an important parameter in determining fruit maturity. The **HI 84532** measures the concentration of titratable hydrogen ions contained in fruit juice samples, by neutralization with a strong base solution to a fixed pH. This value includes all the substances of an acidic nature in the fruit juice including: free hydrogen ions, organic acids and acid salts. Titratable acidity is expressed as g/100 mL of the predominant acid.

The table below lists a variety of common fruit juices along with an approximate titratable acidity range and predominant acid. This table is to be used as a reference only.

| Fruits, juices | Titratable acidity (g/100 mL) | Predominant acid |
|--------------------------------|-------------------------------|------------------|
| Apple, pear | 0.36-0.80 | Malic acid |
| Cranberry | 1.6-3.6 | Citric acid |
| Grapefruit | 1.2-2.0 | Citric acid |
| Lemon | 4-6.2 | Citric acid |
| Mango | 0.34-0.84 | Citric acid |
| Orange | 0.8-1.4 | Citric acid |
| Peach, nectarine, sweet cherry | 0.24-0.94 | Citric acid |
| Pineapple | 0.7-1.6 | Citric acid |
| Plum/Sour cherry | 0.94-1.64 | Malic acid |
| Strawberry | 0.6-1.1 | Citric acid |
| Table grape | 0.4-0.9 | Tartaric acid |
| Tomato | 0.34-1.00 | Citric acid |

The **HI 84532** minititrator uses a method based on the Official Methods of Analysis of AOAC International.

The fruit juice is titrated with sodium hydroxide until the pH end point at 8.1.

The end point is determined by the potentiometric input.

SPECIFICATIONS

| | | | |
|-------------------|--|--|--------------------|
| Titrator | Range | Low range: | 5 mL sample |
| | | g/100 mL as citric acid: | 0.10 - 2.00 %CA |
| | | g/100 mL as tartaric acid: | 0.11 - 2.35 %TA |
| | | g/100 mL as malic acid: | 0.10 - 2.09 %MA |
| | | High range: | 5 mL sample |
| | | g/100 mL as citric acid: | 1.00 - 10.00 %CA |
| | | g/100 mL as tartaric acid: | 1.17 - 11.72 %TA |
| | | g/100 mL as malic acid: | 1.05 - 10.47 %MA |
| | Resolution | 0.01% | |
| | Accuracy | 3% of reading or ± 0.02 %CA @25 °C whichever is greater | |
| | Sample volume | 5 mL | |
| | Titration method | Acid-base titration | |
| | Principle | End point titration: 8.1 pH | |
| | Pump speed | 10 mL/min | |
| | Stirring speed | 600 rpm | |
| | Log data | Up to 200 samples | |
| pH meter | pH meter | - 2.0 to 16.0 pH / - 2.00 to 16.00 pH | |
| | pH Resolution | 0.1 pH / 0.01 pH | |
| | pH Accuracy | ± 0.01 pH | |
| | pH Calibration | 1, 2 or 3 calibration points; 4 available buffers (4.01, 7.01, 8.20, 10.01) | |
| | Temperature compensation | Manual or automatic | |
| mV meter | mV meter | -2000.0 to 2000.0 mV | |
| | mV Resolution: | 0.1 mV | |
| | mV Accuracy: | ± 1.0 mV | |
| | Log data | Up to 200 samples (pH or mV) | |
| Temperature | Range | -20.0 to 120.0 °C (-4.0 to 248.0 °F) | |
| | Resolution | 0.1 °C | |
| | Accuracy | ± 0.4 °C without probe error | |
| Electrode | HI 1131B | | |
| Temperature Probe | HI 7662-T | | |
| Environment | 0 to 50 °C (32 to 122 °F); max 95% RH non-condensing | | |
| Power supply | 12 Vdc power adapter | | |
| Dimensions | 235 x 200 x 150 mm (9.2 x 7.9 x 5.9") | | |
| Weight | 1.9 kg (67.0 oz.) | | |

REQUIRED REAGENTS

| Code | Description |
|---------------|----------------------|
| HI 84532 - 50 | Low Range Titrant |
| HI 84532 - 51 | High Range Titrant |
| HI 84532 - 55 | Calibration Standard |

PRINCIPLE OF OPERATION

Fruit juice acidity is determined by neutralization of all available hydrogen ions present in the sample, with a strong base solution:

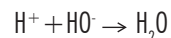

In an ideal solution, the end point of an acid titration corresponds stoichiometrically to the complete neutralization of the acids present.

The pH end point at 8.1 is automatically detected by the pH electrode. End point detection by potentiometric method is more objective than the end point detection using color indicators. For precise results, the sample volume, titrant volume and the titrant concentration must be known.

The **HI 84532** minititrator is designed to determine the acidity of fruit juices. The titration is displayed in % (g/100 mL) of the predominant acid (citric, malic or tartaric acid).

It is important to titrate fresh samples of fruit juice. For increased precision, keep the fruit juices in capped vessels (avoid prolonged exposure to air). Also avoid refrigerating the juice, as significant portion of the tartaric acid (ex. grapes juice) will precipitate out and the results obtained will be lower than expected results.

To maintain the high accuracy of the mini titrator requires a simple pump calibration procedure. The pump calibration involves the analysis of a known volume of a known solution. The instrument will perform a differential analysis to compensate for changes in the dosing system. This procedure should be performed daily.

FUNCTIONAL DESCRIPTION

OVERHEAD VIEW

- 1) Titrant bottle
- 2) Liquid Crystal Display (LCD)
- 3) Keypad
- 4) Electrode holder
- 5) Dispensing tube

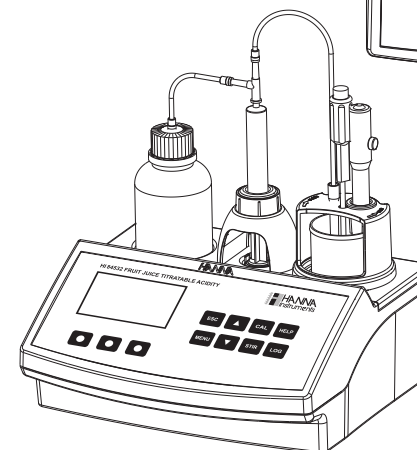
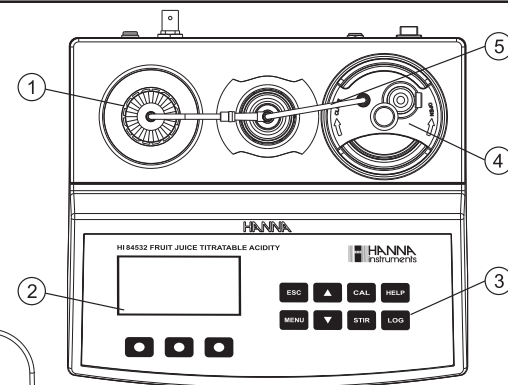

FRONT VIEW

REAR VIEW

- 6) Temperature probe
- 7) pH Electrode
- 8) Electrode holder
- 9) Beaker
- 10) Power switch
- 11) USB connector (PC interface)
- 12) USB connector (Storage interface)
- 13) Power adapter
- 14) BNC electrode connector
- 15) Temperature connector
- 16) Reference connector
- 17) Titrant bottle
- 18) Syringe
- 19) Aspiration Tube
- 20) Dosing Pump Valve

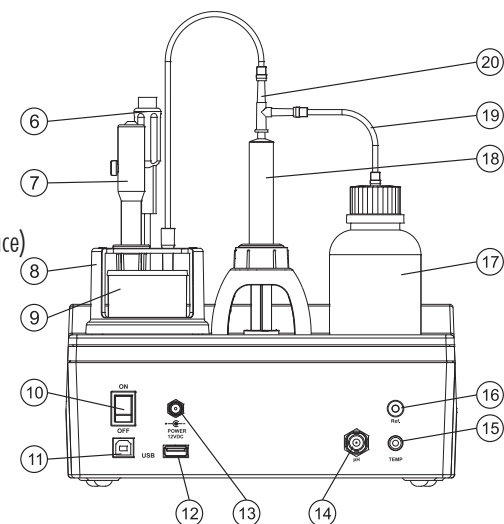

KEYPAD FUNCTION

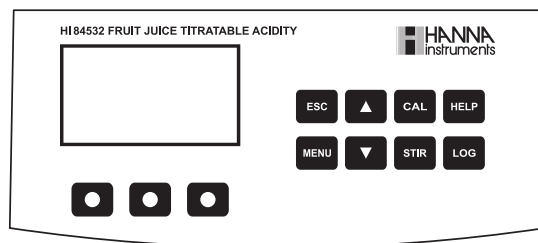

- ESC** - used to leave the current screen and to return either to the previous screen or to the main screen. In **Setup**, exits a parameter without changing the value.
- ▼/▲** - used to modify the parameters' values, to scroll the information displayed while viewing a help screen or to move between the options from the instrument's **Setup**
- CAL** - used to access the Electrode and Pump calibration options
- HELP** - used to access/exit the instrument's contextual help
- LOG** - used to save the current mV/pH reading in pH meter mode and the titration result
- MENU** - used to enter **Setup**, **Recall** or **GLP** selection menu, while instrument is in **pH** or **Titration** mode
- STIR** - used to start/stop the stirrer
Note: The stirrer starts automatically during pump calibration and titration, it cannot be stopped by pressing **STIR** key.

GUIDE TO INDICATORS

During the instrument's operation information is displayed on the LCD.

Displayed icons:

- | | | | | | |
|--|----------------------------------|--|----------------------------|--|-------------------|
| | Stirrer on. | | Pump running. | | Unstable reading. |
| | Stirrer is not working properly. | | Parameter can be modified. | | |

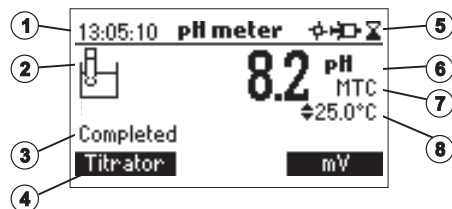

- 1) Current time and instrument mode information (pH meter or Titrator)
- 2) pH electrode condition
- 3) Instrument status
- 4) Virtual option keys

- 5) Stirrer and reading status
- 6) Main reading information
- 7) pH temperature compensation mode (Manual or Automatic)
- 8) Temperature reading

DOSING PUMP

The dosing pump is based on a valve that automatically moves the titrant between the titrant bottle and syringe when filling the syringe and between the syringe and sample when dispensing. A replaceable 5 mL plastic syringe is used to limit the amount of titrant used per test to ensure the highest possible accuracy. Before a set of titrations, it is necessary to prime the dosing system.

Note: Once titrations have been completed, the dosing system should be cleaned with deionized water using the prime feature.

TITRATOR STARTUP

This is a general outline of the steps required to perform a titration. The following topics are expanded upon in each section that follows.

- Place the instrument on a flat table. Do not place the instrument in direct sun light.
 - Connect the power adapter to the instrument.
 - Turn the instrument ON using the power switch on the rear panel of the instrument.
 - Set up the instrument. See the "Setup Menu" section for details.
 - Connect the pH electrode to the instrument.
 - Connect the temperature probe to the instrument.
 - Calibrate the pH electrode.
 - Connect the tubes and the valve. See the "Dosing Pump Prime Procedure" section for the procedure.
 - Remove the titrant bottle cap and replace it with the bottle cap with tubes. Place the titrant bottle in the appropriate place on the titrator top.
- Note:** Different titrants are required based on the concentration. See "Pump Calibration Procedure" for details.
- Prime the syringe. To assure high accuracy, verify there are no air bubbles in the syringe or tubing.
 - Calibrate the pump.

Note: Different volumes of standard are required based on the concentration. See "Pump Calibration Procedure" for details.

- Prepare the sample.
- Run a titration and log sample results.

SETUP MENU

The titrator's setup menu may be accessed from the main screen or titration screens (meter or titrator) by pressing the **MENU** key, then **Setup**.

A list of setup parameters will be displayed with currently configured setting.

While in the setup menu, it is possible to modify the instrument's operation parameters. The **ARROW** keys permit the user to scroll the setup parameters.

Press **HELP** to view the contextual help.

Press **ESC** to return to the main screen.

Concentration Unit



%CA, %MA, %TA.

Press the corresponding virtual option key to change the option.

%CA - % Citric Acid

%MA - % Malic Acid

%TA - % Tartaric Acid

Range Setup

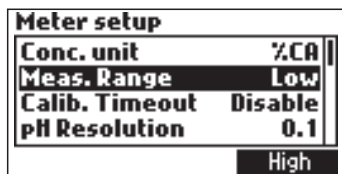

Low Range, High Range.

Use the table below to determine the appropriate range.

Press the corresponding virtual option key to select the new option.

| | Low Range (5 mL sample) | High Range (5 mL sample) |
|-----|----------------------------|-----------------------------|
| %CA | 0.10 to 2.00 | 1.00 to 10.00 |
| %TA | 0.11 to 2.35 | 1.17 to 11.72 |
| %MA | 0.10 to 2.09 | 1.05 to 10.47 |

Note: Different titrant solutions are required for each range.

Calibration Timeout

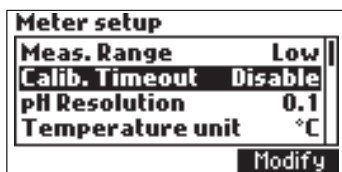

Disabled or 1 to 7 days.

This option is used to set the number of days before the pH calibration expired warning message is displayed.

Press **Modify** to access the calibration timeout screen.

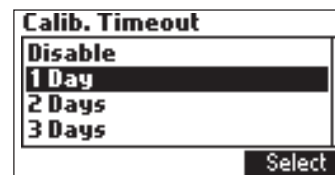

Use the **ARROW** keys to select the value.

Press **Select** to confirm or **ESC** to return to the setup menu without saving the changes.

pH Resolution

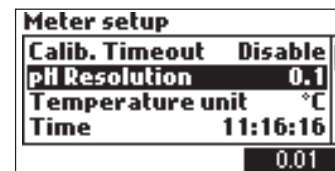

0.1 or 0.01.

Press the displayed virtual option key to change the option.

Temperature Unit

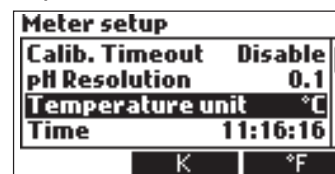

°C, °F or K.

Press the virtual option key to change the option.

Time

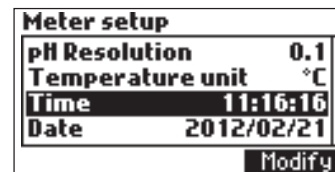

Press the **Modify** key to change the time and time format.

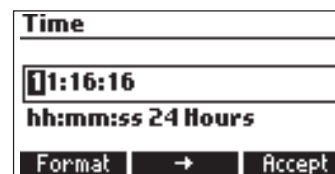

Press **Format** to switch between 12 hour (am/pm) and 24 hour mode.

Press **→** to highlight the value to be modified. Use the **ARROW** keys to change the value. Press **Accept** to confirm the new value or **ESC** to return to the setup.

Date

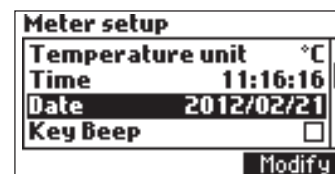

Press the **Modify** key to change the date and date format.

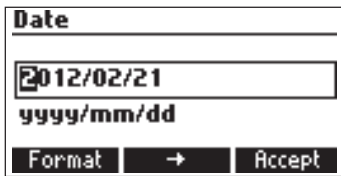

Press **Format** to cycle between the available date formats.

Press **→** to highlight the value to be modified. Use the **ARROW** keys to change the value. Press **Accept** to confirm the new value or **ESC** to return to the setup.

Key Beep



Select **Enable** to activate or **Disable** to deactivate the Key Beep function.

If enabled, a short beep will be heard every time a key is pressed.

Error Beep

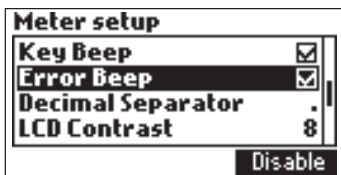

Select **Enable** to activate or **Disable** to deactivate the Error Beep function.

If enabled, a beep will be heard when an error condition occurs.

Decimal Separator

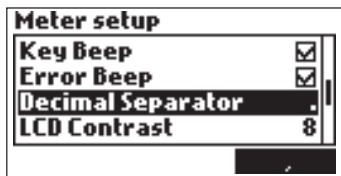

This option allows the user to select the symbol used for a decimal separator.

LCD Contrast

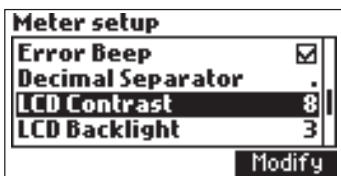

This option is used to set the display's contrast.

Press **Modify** to change the display's contrast. The default value is 8.

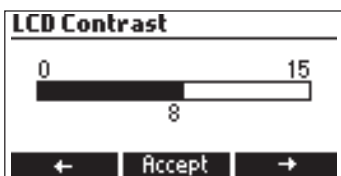

Use the **ARROW** keys or **← / →** to increase/decrease the value. Press **Accept** to confirm the value or **ESC** to return to the setup menu.

LCD Backlight

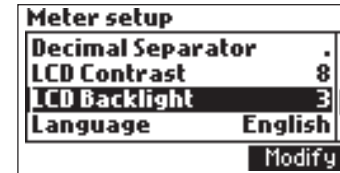

Press **Modify** to change the backlight level. The default value is 3.

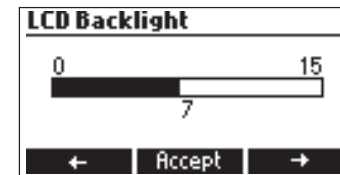

Use the **ARROW** keys or **← / →** to increase/decrease the backlight level.

Press **Accept** to confirm or **ESC** to return to the setup menu.

Language



Press the corresponding virtual option key to change the language.

If the selected language cannot be loaded, the previously selected language will be reloaded.

If no language can be loaded at startup, the instrument will work in "safe mode". In "safe mode" all messages are displayed in English and tutorial and help information are not available.

Tutorial

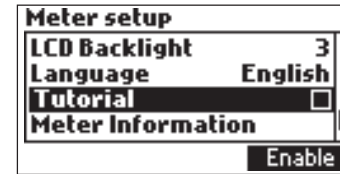

Enable or **Disable** the Tutorial. This helpful tool offers additional information during calibration and titration.

Meter Information

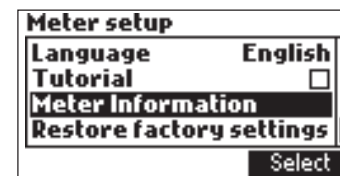

Press **Select** to view the firmware version, language version, mV factory calibration date and time and temperature factory calibration date and time.

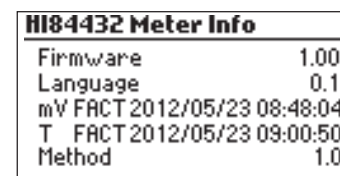

Press **ESC** to return to the **Setup** mode.

Restore Factory Settings

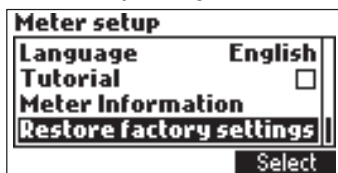

Press **Select** to restore factory settings.

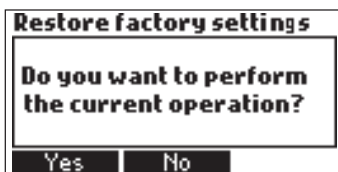

Press **Yes** to confirm the restore process or **No** to return without restoring.

Press **ESC** to return to the **Setup** mode.

GUIDE TO DISPLAY CODES



This screen appears when the instrument is turned on during the initialization process.

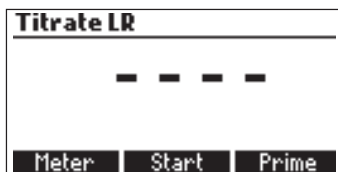

Titration screen display.

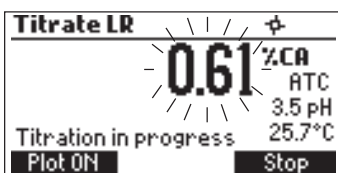

Titration screen when a titration is in progress.

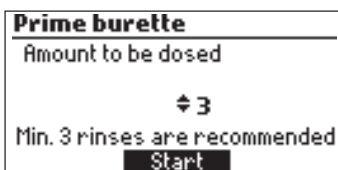

Prime burette screen.



Prime burette screen when the dosing system is running.

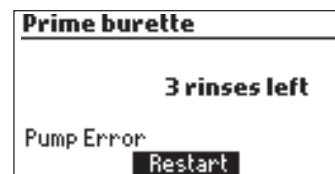

This error message appears when the pump is not working properly. Check the tubing, valve and syringe. Press **Restart** to try again.

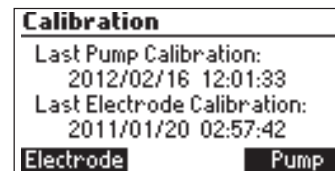

This screen appears when the titrator is in calibration mode.

Press **Pump** to calibrate Pump.

Press **Electrode** to calibrate pH Electrode.

PUMP CALIBRATION MESSAGES



Pump calibration is initiated by pressing the **Start** key.

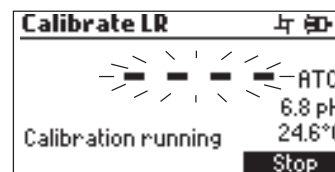

This screen appears while pump calibration is in progress. Press **ESC** or **Stop** key to return to the Pump Calibration screen.

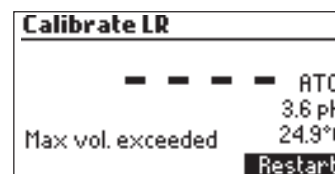

This error message appears during pump calibration when the end point can not be reached and the maximum amount of titrant is exceeded. Check standard, electrode and/or dosing system and try again.

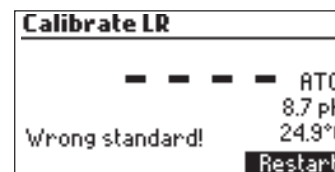

The calibration was outside the acceptable limits. Prepare a new standard and try again.

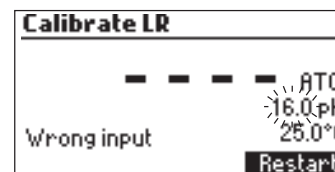

This error message appears when the pH reading exceeds the acceptable input limits (-2.00 < pH > 16.00).

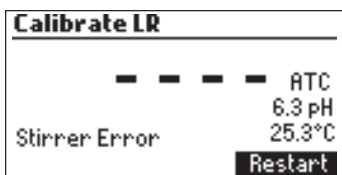

This screen appears when the stirrer is not working properly. Check the stir bar and beaker content. Press **Restart** to try again.

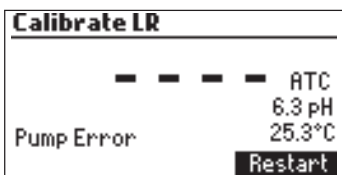

This error message appears when the pump is not working properly. Check the tubing, valve and syringe. Press **Restart** to try again.

pH CALIBRATION MESSAGES

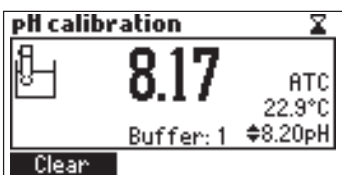

pH calibration mode.

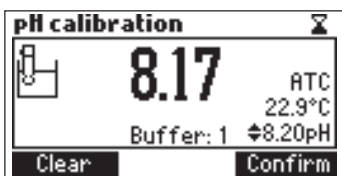

When the reading has stabilized, press **Confirm** to accept the calibration or **Clear** to restore the default calibration.

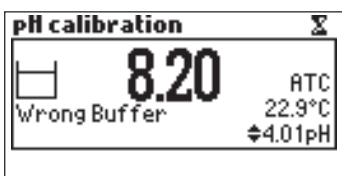

The "Wrong Buffer" message is displayed when the pH value is outside of the acceptable range. Clean the electrode by following the Cleaning Procedure and/or check the buffer concentration before continuing the pH calibration.

Press the ESC key to exit pH calibration mode.

TITRATION MESSAGES

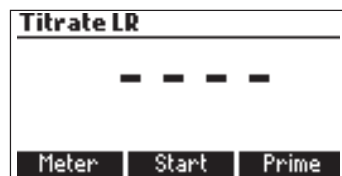

This screen is displayed when the instrument is in titration mode. Press **Start** to begin a titration, **Meter** to enter pH meter mode or **Prime** to enter into the prime function.



The titration result, expressed as %CA, %TA or %MA is displayed automatically at the end of the titration. Press **Restart** to start a another titration or **ESC** to return to the main screen.

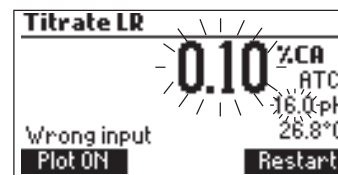

This error message appears when the input reading (pH or temperature) exceeds the specified limits. The pH or temperature value and the concentration will blink indicating an error.

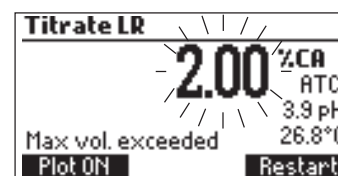

This screen appears when the sample concentration is out of range.

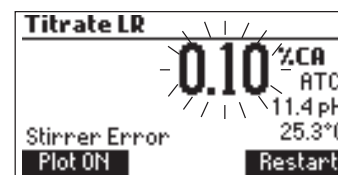

This screen appears when the stirrer is not working properly. Check the stir bar and beaker content. Press **Restart** to try again.

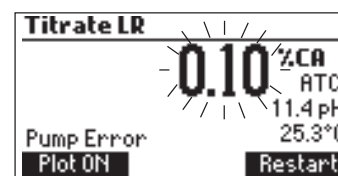

This error message appears when the pump is not working properly. Check the tubing, valve and syringe. Press **Restart** to try again.

ELECTRODE PREPARATION

PREPARATION PROCEDURE

Remove the electrode protective cap.

DO NOT BE ALARMED IF ANY SALT DEPOSITS ARE PRESENT. This is normal with electrodes and they will disappear when rinsed with distilled/deionized water.

During transport, tiny bubbles of air may have formed inside the glass bulb. The electrode cannot function properly under these conditions. These bubbles can be removed by "shaking down" the electrode as you would do with a glass thermometer.

If the bulb is dry, soak the electrode in **HI 70300** Storage Solution for at least one hour.

ELECTRODE CALIBRATION PROCEDURE

It is recommended to calibrate the instrument frequently, especially if high accuracy is required.

The pH electrode should be recalibrated:

- Whenever the pH electrode is replaced
- At least once a week, but daily is advised
- After testing aggressive chemicals and after the electrode is cleaned
- When high accuracy is required
- If the pH calibration expired warning is displayed during measurement

Every time you calibrate the instrument use fresh buffers and clean the electrode (see page 40).

PROCEDURE

A single, one, two or three-point calibration can be performed, using four predefined buffers 4.01, 7.01, 8.20 and 10.01 pH. For a single point calibration any of the four buffers may be used, 8.20 pH is recommended.

Note: The HI 84532 will not accept other pH buffers for calibration.

- Pour small quantities of selected buffer solutions into clean beakers. For accurate calibration use two beakers for each buffer solution, the first one for rinsing the electrode and the second one for calibration.
- Put a magnetic stir bar in the beaker that will be used for calibration.
- Remove the protective cap and rinse the electrode with some of the buffer solution to be used for the first calibration point.
- Put the first beaker with calibration buffer in the beaker holder.
- Place the electrode holder on the top of the beaker and secure it by turning clockwise and press **STIR**.
- Immerse the pH electrode and the temperature probe approximately 2 cm (0.8") into the buffer, paying attention not to touch the stir bar.

To enter Electrode Calibration follow the next steps:

- Press **CAL** function key then **Electrode**.
- The electrode calibration screen will be displayed.
- Press **Clear** to delete the previous calibration.

Point 1 calibration

- The 8.20 buffer will be selected by default. If necessary, press the **ARROW** keys in order to select a different buffer value.
- The **Σ** (unstable measurement) symbol will be shown on the display until the reading becomes stable.

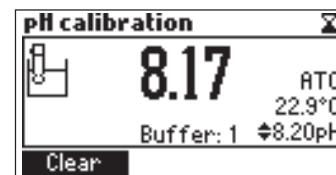

- When the reading is stable and close to the selected buffer, the **Σ** (unstable measurement) symbol will disappear and the **Confirm** key will become active.

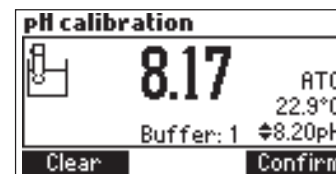

- Press **Confirm** to confirm the calibration or **ESC** to exit calibration.
- After the calibration point has been confirmed, press **ESC** to exit without performing the second calibration point.

Point 2 calibration

- The calibrated value will be shown on the display and the second expected buffer value will be displayed.

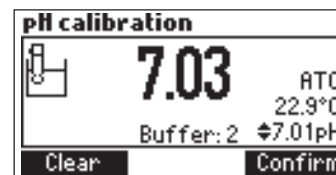

- Remove the electrode holder with electrodes from the top of the beaker.
- Place the second beaker with calibration buffer in the beaker holder. Rinse the electrodes in a beaker containing the second buffer rinsing solution.
- Place the electrode holder (with electrodes) on the top of the beaker and secure it by turning clockwise and press **STIR**.

- If necessary, press the **ARROW** keys in order to select a different buffer value.
- The **Σ** (unstable measurement) symbol will be shown on the display until the reading becomes stable.
- When the reading is stable and close to the selected buffer, the **Σ** (unstable measurement) symbol will disappear and the **Confirm** key will become active.
- Press **Confirm** to confirm the calibration.
- The calibrated value will be shown on the display and the third expected buffer value will be automatically selected.
- After the second calibration point has been confirmed, press **ESC** to exit without performing the third calibration point.

Point 3 calibration

- Remove the electrode holder with electrode from the top of the beaker.
- Place the third beaker with calibration buffer in the beaker holder. Rinse the electrodes in a beaker containing the third buffer rinsing solution.
- Place the electrode holder (with electrodes) on the top of the beaker and secure it by turning clockwise and press **STIR**.
- If necessary press the **ARROW** keys in order to select a different buffer value.
- The **Σ** (unstable measurement) symbol will be shown on the display until the reading becomes stable.
- When the reading is stable and close to the selected buffer, the **Σ** (unstable measurement) symbol will disappear and the **Confirm** key will become active.
- Press **Confirm** to confirm the calibration. The instrument stores the calibration value and returns to calibration menu, where the date and time for the pH calibration will be updated.

Note:

- A buffer confirmed during the calibration process is removed from the list of available buffers.
- If the value measured by the instrument is not close to the selected buffer, a **"Wrong Buffer"** error message will be shown on the display.

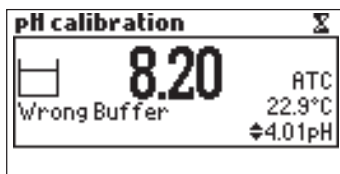

Check if the correct buffer has been used or regenerate the pH electrodes by following the Cleaning Procedure (see page 40). If necessary change the buffer or the electrode.

- If the measured offset isn't within the preset limits (± 45 mV), the meter will display the message **"Buffer Contaminated"** alternatively with **"Electrode Dirty/Broken"**.

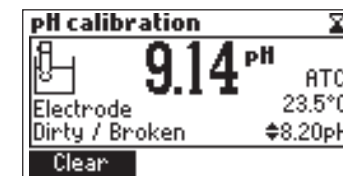
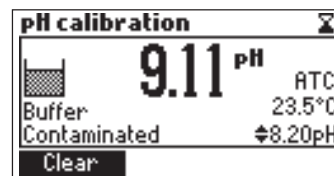

- If the computed slope isn't within the preset limits, the meter will display the message **"Wrong Slope"**. If the slope is too high the symbol **▲** will be displayed. If the slope is too low the symbol **▼** will be displayed.

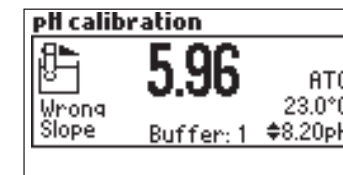
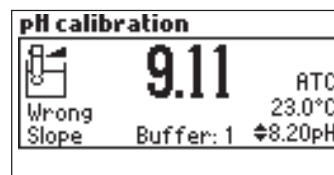

- If the **"Wrong Old Slope"** error message is displayed, an inconsistency exists between the current and the previous (old) calibration. Clear the previous calibration by pressing **Clear** and proceed with calibration from the current calibration point. The instrument will keep all the confirmed values during the current calibration.



- If the temperature reading is out of the defined temperature range of the buffer (0 to 45 °C), the **"Wrong Buffer Temperature"** error message will be displayed, and the temperature symbol will blink on the display. Calibration cannot be confirmed in this situation.

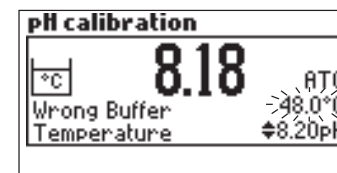

- Note:**
- To clear a previous calibration and to return to the default value, press **Clear** at any time after entering calibration mode. If **Clear** is invoked during the first calibration, point the instrument returns to the measurement mode.
 - The **Clear** key is displayed only if a previous calibration exists.

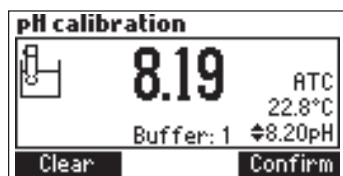

pH BUFFER TEMPERATURE DEPENDENCE

Temperature has an effect on pH. The calibration buffer solutions are affected by temperature changes to a lesser degree than normal solutions. During calibration, the instrument will automatically calibrate to the pH value corresponding to the measured or set temperature.

| TEMP | | pH BUFFERS | | | |
|------|-----|------------|------|------|-------|
| °C | °F | 4.01 | 7.01 | 8.20 | 10.01 |
| 0 | 32 | 4.01 | 7.13 | 8.38 | 10.32 |
| 5 | 41 | 4.00 | 7.10 | 8.34 | 10.24 |
| 10 | 50 | 4.00 | 7.07 | 8.31 | 10.18 |
| 15 | 59 | 4.00 | 7.04 | 8.27 | 10.12 |
| 20 | 68 | 4.00 | 7.03 | 8.23 | 10.06 |
| 25 | 77 | 4.01 | 7.01 | 8.20 | 10.01 |
| 30 | 86 | 4.02 | 7.00 | 8.17 | 9.96 |
| 35 | 95 | 4.03 | 6.99 | 8.14 | 9.92 |
| 40 | 104 | 4.04 | 6.98 | 8.11 | 9.88 |
| 45 | 113 | 4.05 | 6.98 | 8.08 | 9.85 |

During calibration the instrument will display the pH buffer value at 25 °C.

DOSING PUMP INSTALLATION

To install the dosing pump follow the procedure below:

- Extend the plunger on the 5 mL syringe to its maximum volume.
- Place the syringe in the dedicated spot on the top of the meter (1).
- Arrange the bottom of the syringe into the holder on the pump (2). Once the syringe is in place lower the barrel until it sits flush on the holder.
- Put the o-ring and syringe-fixing nut over the syringe (3) and turn clockwise to secure it in place (4).
- Place the valve on the top of the syringe (5). Ensure it fits securely.
- Insert the aspiration tube into the left side of the valve (6) and replace the titrant bottle cap with the attached cap (7).
- Insert the dispensing tube into the top of the valve (8).

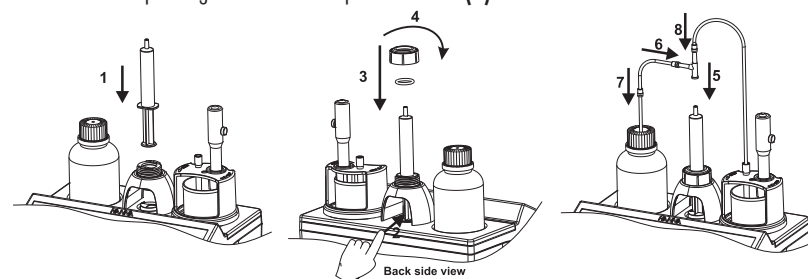

DOSING PUMP PRIME PROCEDURE

Prime cycle should be performed:

- if you notice there is no titrant in the tip
- whenever the dosing system tubes are replaced
- whenever a new bottle of titrant is used
- before starting a pump calibration
- before starting a series of titrations

The prime cycle is used to fill the syringe before starting a set of titrations.

Two rinsescycles of the syringe are shown in the figure below. The dispensing tube is connected to the top of the valve and the aspiration tube on the left side.

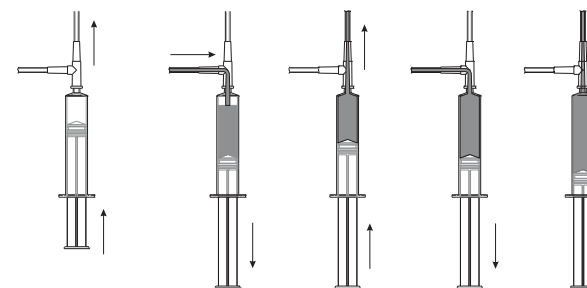

Note: • The aspiration tube must be inserted in the titrant bottle. The dosing tip must be placed over a rinse beaker.

- Before starting the prime procedure, make sure you are using the appropriate titrant solution for the selected range.

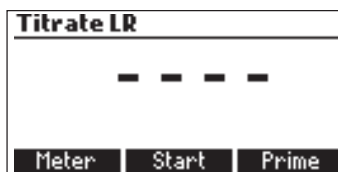

- To prime the burette, select **Prime** option from **Titration** mode.
- Adjust the rinses number by pressing the **▼** and **▲** keys and press **Start**.

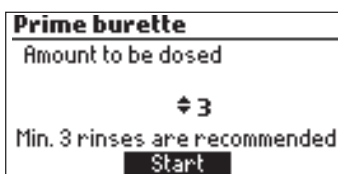

- The number of syringe rinses can be set between 1 and 5 (at least three rinses are recommended to ensure that the air bubbles are completely removed).

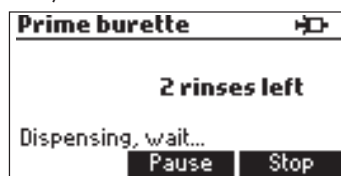
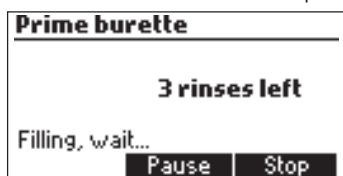

- To pause the prime process press the **Pause** key; to continue press the **Continue** key. To stop the prime process press the **Stop** key.

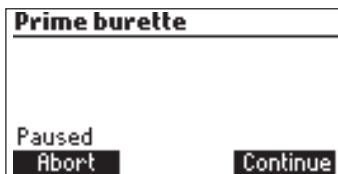

Note: This error message appears when the pump is not working properly. Check the tubing, valve and syringe. Press **Restart** to try again.



PUMP CALIBRATION PROCEDURE

The calibration of the pump must be performed every time the syringe, pump tube, the titrant bottle or the pH electrode is changed. It is recommended to perform the pump calibration before each set of titrations, after the titrator is left idle for several hours, or once daily.

- Press **Menu**, select **Setup** and select the corresponding measurement range according to the table below:

| Low Range | High Range |
|------------------|-------------------|
| 0.10 to 2.00 %CA | 1.00 to 10.00 %CA |
| 0.11 to 2.35 %TA | 1.17 to 11.72 %TA |
| 0.10 to 2.09 %MA | 1.05 to 10.47 %MA |

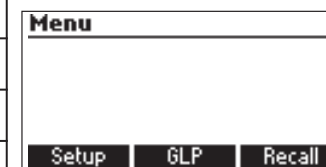

- Verify the electrode has been calibrated in 8.20 pH buffer.
- Ensure the pump is primed with the correct titrant for the selected range (**HI 84532-50** Low Range Titrant or **HI 84532-51** High Range Titrant).

Sample preparation: Using a clean pipette to precisely add the appropriate amount of **HI 84532-55 Calibration Standard** to a clean beaker as indicated below:



Low Range (5 mL)
High Range (10 mL)

Note: Failure to use a clean pipette will result in erroneous readings.

- Fill the beaker up to the 50 mL mark with the distilled or deionized water.
- Press **CAL** key. The instrument displays the date and time of the last electrode calibration, and the last pump calibration.
- Press **Pump** key.

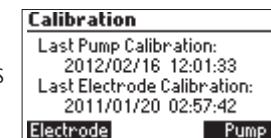

Note: **DO NOT PLACE THE DISPENSING TIP INTO THE CALIBRATION BEAKER, PLACE THE TIP OVER A WASTE BEAKER. A SMALL AMOUNT OF TITRANT IS DISPENSED WHEN THE PUMP RESETS.**



- Press **Start**, wait for the syringe to refill.
- Place the stir bar in the beaker and put the beaker in the minititrator top.

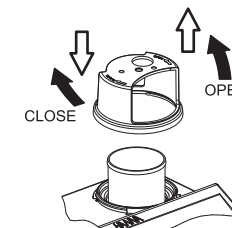

- Place the probe holder on the top of the beaker and secure it by turning clockwise.
- Rinse the pH electrode with deionized water and immerse into the sample until the reference junction is completely submerged. Be sure that the tip of the electrode is not hitting the stir bar. If necessary, additional distilled or deionized water can be added.
- Insert the dosing tip into the titrant tube sleeve. **IT IS CRITICAL THAT THE TIP BE IMMERSSED APPROXIMATELY 0.25 CM (0.1") INTO THE SOLUTION BEING TITRATED.**
- Press **Continue** to begin the calibration and **Stop** to abort it.
- At the end of the calibration, "**Calibration Completed**" appears on display. To repeat the calibration press **Restart** or **ESC** to return to the main screen.

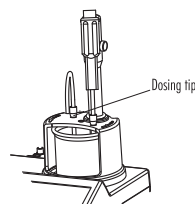

Calibrate LR
 Prepare the standard. Add stir bar to beaker. Attach the electrode holder. Insert electrodes and dosing tip.
 Continue Stop

Calibrate LR
 Calibration completed ATC
 10.20 pH
 Completed 25.0°C
 Restart

- Note:**
- If temperature probe is not connected, **Manual Temperature Compensation** is used and **MTC** appears on the right side of the screen. If **Automatic Temperature Compensation** is in use the **ATC** appears on the right side of the screen.
 - If an erroneous situation is encountered during the calibration, an error message is displayed and the calibration can be restarted by pressing **Restart**. Prepare a new standard, rinse electrode, temperature probe and dosing tip and try again.

Calibrate LR
 Wrong standard!
 ATC
 8.78 pH
 24.9°C
 Restart

- If the calibration doesn't complete and the max titrant volume is reached, an error message will be displayed. The calibration can be restarted by pressing **Restart**. Prepare a new standard, rinse the electrode, temperature probe and dosing tip and try again.

Calibrate LR
 Max vol. exceeded
 ATC
 3.68 pH
 24.9°C
 Restart

TITRATION PROCEDURE

- For best accuracy, before taking any measurement, ensure that the pump is calibrated on the selected range following the "Pump Calibration Procedure" (see page 27).
- Note:** Verify that the instrument has been calibrated (pH and pump) before performing any titrations.
- Refer to "Setup Menu" (see page 12) to set up the instrument for your measurement.
 - Select the corresponding measurement range.

| Low Range (5 mL sample) | High Range (5 mL sample) |
|----------------------------|-----------------------------|
| 0.10 to 2.00 %CA | 1.00 to 10.00 %CA |
| 0.11 to 2.35 %TA | 1.17 to 11.72 %TA |
| 0.10 to 2.09 %MA | 1.05 to 10.47 %MA |

Titrate LR
 Meter Start Prime

- Ensure the pump is primed with the correct titrant for the selected range (**HI 84532-50** Low Range Titrant or **HI 84532-51** High Range Titrant).

Sample preparation: Using a clean pipette to precisely add the appropriate amount of sample to a clean beaker as indicated below:

Low Range (5 ml)
 High Range (5 ml)

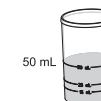

Note: Failure to use a clean pipette will result in erroneous readings.

- Put the sample in the 50 mL beaker. Fill the beaker up to 50 mL with deionized water.
- Press **Titrate**.

Titrate LR
 Titration in progress
 ATC
 3.9 pH
 24.3°C
 Stop

Note: **DO NOT PLACE THE DISPENSING TIP INTO THE SAMPLE BEAKER. PLACE THE TIP OVER A WASTE BEAKER. A SMALL AMOUNT OF TITRANT IS DISPENSED WHEN THE PUMP RESETS.**

- Press **Start** to begin a titration.
- Place the stir bar in the beaker and put the beaker in the minititrator top.
- Place the probe holder on the top of the beaker and secure it by turning clockwise.

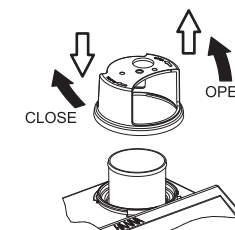

- Rinse the pH electrode with deionized water and immerse into the sample until the reference junction is completely submerged. Be sure that the tip of the electrode is not hitting the stir bar.
- Insert the dosing tip into the titrant tube sleeve. **IT IS CRITICAL THAT THE TIP BE IMMERSSED APPROXIMATELY 0.25 CM (0.1") INTO THE SOLUTION BEING TITRATED.**
- Press **Continue** to begin the titration and **Stop** to abort it.

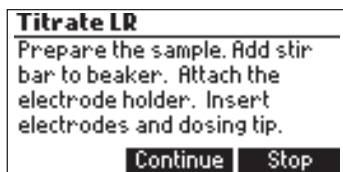
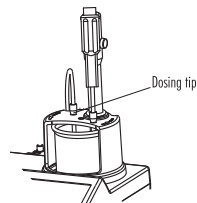

- The instrument will continuously update the concentration on the display. The value will be displayed blinking. When the reading is under range "----" symbol appears blinking.

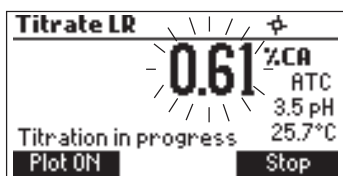
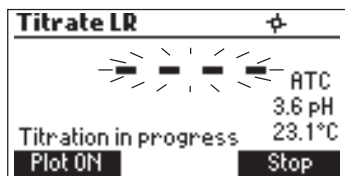

- The titration curve can be visualized during a titration by pressing **Plot ON**. Press **Plot OFF** to exit this mode.

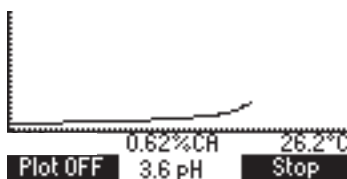

- At the end of the titration, the concentration is displayed in the selected unit. The titration curve can be viewed by pressing **Plot ON**. Press **Plot OFF** to exit this mode.

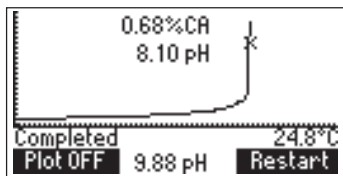
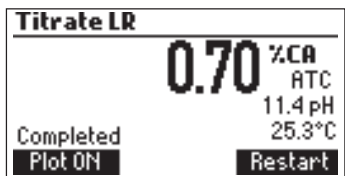

- Press **LOG** to record the concentration value and the titration curve into the instrument's memory. A message will be displayed for a few seconds indicating the amount of free log space. Up to 200 log samples can be recorded in the instrument's memory.

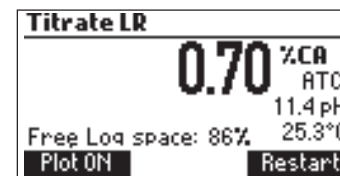

- Press **Restart** to begin a new titration or **ESC** to return to the titration menu.

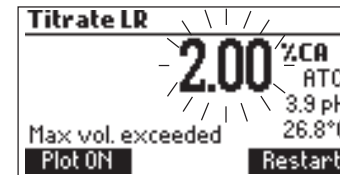

- If the concentration exceeds the range limits, the exceeded range limit will be displayed blinking. Another titration can be started by pressing **Restart**.

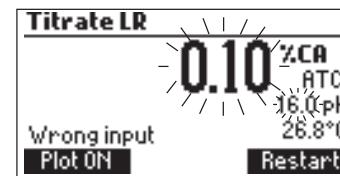

- "Wrong input" error message appears when the input reading (pH, temperature) exceeds the specified limits. The pH or temperature value and the concentration will blink indicating an error.

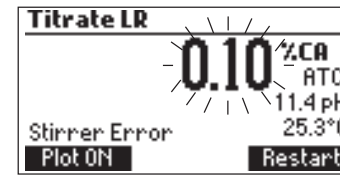

- This screen appears when the stirrer is not working properly. Check the stir bar and beaker content. Press **Restart** to try again.

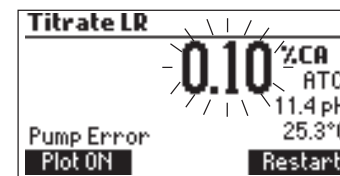

- This error message appears when the pump is not working properly. Check the tubing, valve and syringe. Press **Restart** to try again.

TIPS FOR AN ACCURATE MEASUREMENT

The instructions listed below should be followed carefully to ensure measurements are conducted with the highest possible accuracy and precision.

- **IT IS CRITICAL THAT THE TIP BE IMMERSSED IN THE SOLUTION BEING TITRATED (APPROXIMATELY 0.25 CM).**
- Use a clean, volumetric pipette to measure and transfer the necessary volume of sample into the titration beaker.
- Calibrate the pump prior to each series of titrations.
- Calibrate the pump if the meter is left idle for several hours.
- Analyze the sample immediately after it is obtained.
- For better performance, soak the electrode in **HI 70300** storage solution for at least one hour before use.

VIEW/DELETE TITRATOR RECORDED DATA

Press **MENU** key then **Recall** to access the titrator logs.

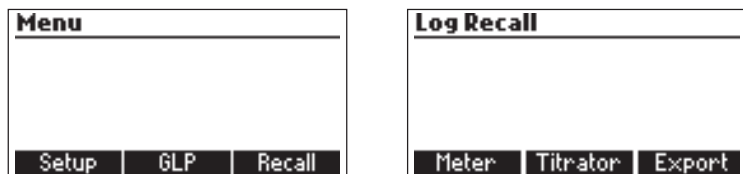

When an external USB storage device is connected, the **Export** key is displayed. It saves the meter and titrator logs in two text format files on the storage device.

Press **Meter** or **Titrator** to view the respective logs.

The instrument will display a list of all the records stored in the log.

Use the **ARROW** keys to scroll the list of records.

If the saved concentration was out of range, the "<" or ">" symbols are displayed in front of the reading.

| | %CA | Date |
|---|--------|------------|
| 1 | < 0.10 | 2012-05-31 |
| 2 | 1.20 | 2012-05-31 |
| 3 | > 8.00 | 2012-05-31 |
| 4 | < 1.00 | 2012-05-31 |

Buttons: Delete, Del.All, Info

Press **Delete** to delete the selected log from the memory.

Press **Del.All** to delete all records.

Press **Info** to see detailed information about the highlighted record.

The selected record data and the titration curve data file name are displayed.

| Record number: 1 | |
|------------------|-------------|
| 2012/05/31 | 04:55:01 PM |
| < 0.10%CA | 25.6°C |
| 0610890.txt file | |

Buttons: Plot, Export

When a USB storage device is connected, the **Export** key is displayed. It saves the titration curve data as a text file on the storage device using the displayed file name.

Use the **ARROW** keys when \blacktriangle is displayed to scroll between the log records.

Press **ESC** to return to the previous screen.

| Record number: 1 | |
|------------------|-------------|
| 2012/05/31 | 04:55:01 PM |
| < 0.10%CA | 25.6°C |
| 0610890.txt file | |

Buttons: Plot, \blacktriangle

Press **Plot** to visualize the titration curve or **ESC** to return to the previous screen. On the titration curve, the end point volume and pH are displayed. The titration data (Total Titrant Volume on the x-axis and pH on the y-axis) can be scanned through with the dotted line by using the **ARROW** keys.

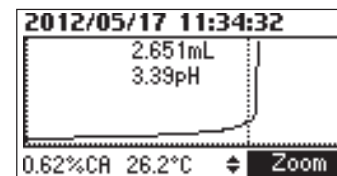

To zoom on the titration curve press **Zoom**.

If **Delete** or **Del.All** is pressed the instrument will ask for confirmation.

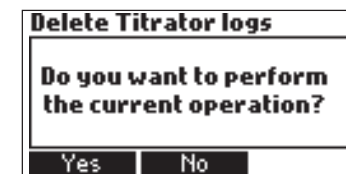
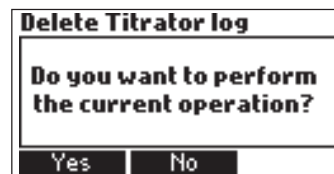

Press **Yes** to delete the record or **No** to return to the previous screen.

Deleting a single record will renumber the list of records.

If the titrator log is empty, the message "**No records available!**" will be displayed.

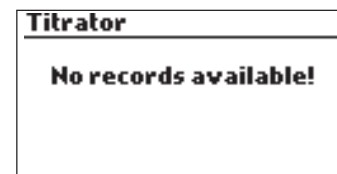

TITRATOR GLP INFORMATION

Press **MENU** then **GLP**.

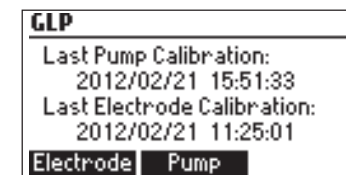
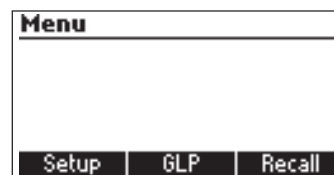

From this screen it is possible to select **Electrode** or the **Pump** GLP.

Press **Pump** to view the pump's last calibration time, date and slope.

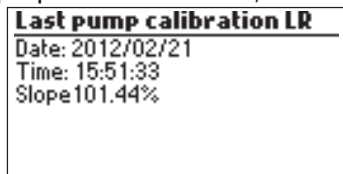

If a calibration hasn't been performed, the message "Not Calibrated" will be displayed.

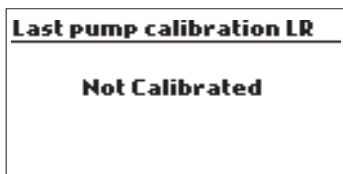

pH MEASUREMENT

The HI 84532 can be used as a pH meter for direct measurements.

Verify that the instrument has been calibrated before taking pH measurements. Set the instrument to **pH meter**. From titrator mode press **Meter** until pH units are displayed.

If an electrode calibration hasn't been performed, or the number of days exceeds the calibration time out value set, the message "CAL DUE" will blink on the left side of the display (see **Calibration timeout** option in **Setup** for details).

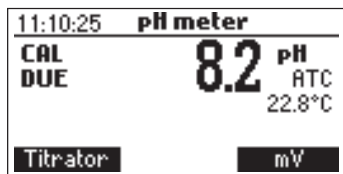

If **CAL DUE** is displayed perform an electrode calibration.

Press **MENU** to access the instrument's menu.

Press **HELP** to view the contextual help whenever time you need additional information.

Press **STIR** to start/stop the stirrer.

Press **Titrator** to enter titration mode.

Press **CAL** to access the calibration menu.

Press **LOG** to save the current reading. A message indicating the free log space will be displayed for a few seconds.

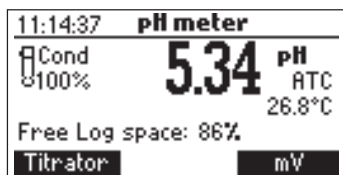

In order to take pH measurements, follow the next steps:

- Submerge the pH electrode 2 cm (0.8") and the temperature probe into the sample to be tested and stir gently. Allow time for the electrode to stabilize. When the reading becomes stable, the **⚡** (unstable measurement) symbol will disappear.

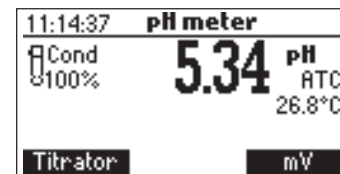

- If the pH reading is less than -2.00 pH or greater than 16.00 pH, the closest full-scale value will be displayed blinking.

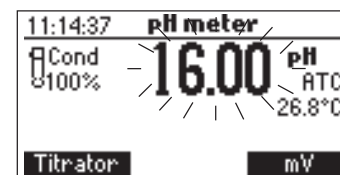

If measurements are taken successively in different samples, it is recommended to rinse the electrodes thoroughly with deionized or distilled water and then with some of the next sample to prevent cross-contamination.

The pH measurements are affected by temperature. In order to have accurate pH measurements, the temperature effect must be compensated for. To use the Automatic Temperature Compensation (ATC) feature, connect and submerge the HI 7662-T temperature probe into the sample as close as possible to the electrode and wait for a few seconds. The "ATC" message will be shown on the display. Automatic Temperature Compensation will provide pH corrected values for the measured temperature. If Manual Temperature Compensation (MTC) is desired, the temperature probe must be disconnected from the instrument.

The default temperature of 25 °C (77 °F) or the last temperature reading will be displayed, preceded by the symbol **⬆** and the "MTC" message.

The temperature can be adjusted with the **ARROW** keys (from -20.0 to 120.0 °C).

VIEW/DELETE RECORDED pH DATA

To view or delete previously logged pH records, press **MENU** then **Recall** to access the pH logs.

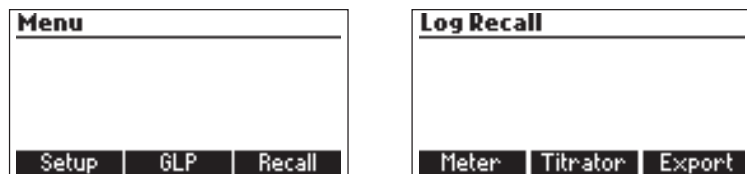

A list of records is stored in the pH log.

When an external USB storage device is connected, the **Export** key is displayed. It saves the meter and titrator logs in two text format files on the storage device.

Press **Meter** or **Titrator** to view the respective logs.

If the saved mV/pH measurements are out of range, the "<" or ">" symbols are displayed in front of the reading.

| | mV/pH | Date |
|---|-------------|------------|
| 1 | 5.24pH | 2012/05/22 |
| 2 | > 16.00pH | 2012/05/22 |
| 3 | < -2000.0mV | 2012/05/22 |
| 4 | -100.0mV | 2012/05/22 |

At the bottom of the table are three buttons: **Delete**, **Del.All**, and **Info**.

Use the **ARROW** keys to scroll the list of records.

Press **Delete** to delete the selected log from the memory.

Press **Del.All** to delete all records.

Press **Info** to see detailed information about the highlighted record.

Use **ARROW** keys when \updownarrow is displayed to scroll between the records.

| Record number: 1 | |
|------------------|----------|
| 2012/05/22 | 16:01:48 |
| 5.24 pH | 25.1°C |
| Offset: 0.02mV | |
| Slope: 100.1% | |

At the bottom center of the table is a \updownarrow symbol.

Press **ESC** to return to the previous screen.

If **Delete** or **Del.All** is pressed the instrument will ask for confirmation.

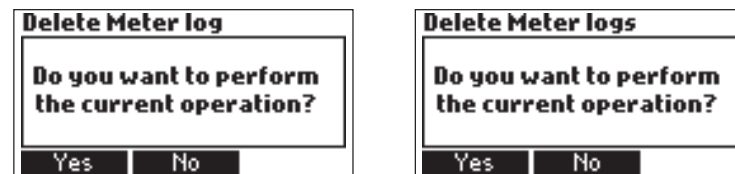

Press **Yes** to delete the record or **No** to return to the previous screen without deleting.

Deleting a single record will renumber the list of records.

If the pH log is empty, the message "**No records available!**" will be displayed.

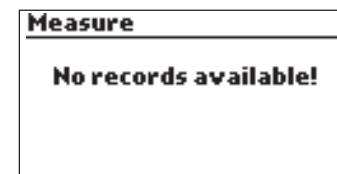

pH METER GLP INFORMATION

The pH meter GLP screens displays the last pH calibration data.

To view this information press **MENU** key then **GLP**.

Press **Electrode** to view information regarding electrode calibration.

| Last Electrode Calibration | |
|----------------------------|------|
| Date: 2012/05/31 | 8:20 |
| Time: 05:13:04 PM | 7.01 |
| Cal Expire: 3 Days | 4.01 |
| Offset: 1.4mV | |
| Slope: 102.9% | |
| Electrode Condition: 100% | |

The following items are included in electrode GLP: the time and date of the last calibration, offset, slope, electrode condition, calibration timeout and the calibration buffers. The buffers displayed in video inverse mode are from the previous calibration.

If a calibration hasn't been performed, the message "**Not Calibrated**" will be displayed.

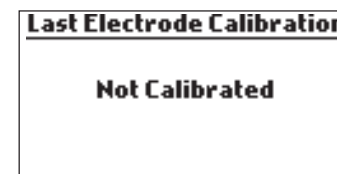

PC INTERFACE AND DATA TRANSFER

Data stored on the meter with the **LOG** function during pH/mV measurement and titrations can be transferred from the meter to a **USB stick** using the **Export** function from the log recall menu. Two text files are transferred on the USB stick. These files can be used for further analysis on a PC. The logged data can also be transferred from the instrument to the PC using a USB cable. Connect the USB cable and the following screen will be displayed.

Press **Meter** to generate the text file with Meter log data.

Press **Titration** to generate the text file with Titration log data.

Press **Plot** to generate the text files with Titration Plots.



The generated files are now visible and can be used for further analysis.

If the instrument has no logged Meter or Titration records, the PC connected screen is displayed.



TROUBLESHOOTING GUIDE

| SYMPTOMS | PROBLEM | SOLUTION |
|--|--|---|
| Slow response/excessive drift. | Dirty pH electrode. | Soak the electrode tip in HI 7061 cleaning solution for 30 minutes. Refill with fresh fill solution. |
| Reading fluctuates up and down (noise). | Clogged/dirty junction. Low electrolyte level (refillable pH electrodes only). Cable connection. | Soak the electrode tip in HI 7061 cleaning solution for 30 minutes. Refill with fresh fill solution. Check cable connection to meter and verify protective cap is off. |
| While in pH reading mode, -2.00 or 16.00 pH is displayed blinking. | Reading out of range. | Check cable connection to meter and verify protective cap is off. Check the quality of the sample. Clean the electrodes. Refill with fresh fill solution. |
| The meter does not accept the pH buffer solution for calibration. | Broken pH electrode. | Replace the electrode or contact the vendor. |
| The pump calibration can't be performed | Broken pump tubing. Wrong or contaminated pump calibration solution. Broken pH electrode. | Verify tubing, valve, syringe are intact and solution passes when pump is primed and no air bubbles are present. Check the pump calibration solution. Verify electrode is calibrated in fresh pH buffers. Prepare another standard, prime the pump and restart the calibration. |
| The temperature probe is connected, but the meter displays "MTC". | Broken temperature probe. | Replace temperature probe. |

| SYMPTOMS | PROBLEM | SOLUTION |
|--|--|--|
| After a titration, the instrument displays 2.00 %CA, 2.35 %TA or 2.09 %MA for low range; 8.00 %CA, 9.37 %TA or 8.37 %MA for high range, with the selected unit blinking. | Broken electrode. Instrument not calibrated. Wrong sample. Concentration out of range. | Check/clean the electrodes. Recalibrate the instrument (pump and pH). Use care during sample preparation. Check sample size and permitted range. |
| At startup, the meter displays the HANNA logo permanently. | One of the keys is stuck. | Check the keyboard or contact the vendor. |
| "Error xx" message is displayed. | Internal error. | Power off the meter and then power it on again. If the error persists, contact the vendor. |
| "Stirrer error" message is displayed at the end of pump calibration or titration. | Check the stir bar and beaker content. | If the error persists, contact the vendor. |
| Non-spinning stirrer icon blinking in pH calibration and meter mode. | Check the stir bar and beaker content. | If the error persists, contact the vendor. |
| "Pump error" message is displayed. | Check the tubing, valve and syringe. | If the error persists, contact the vendor. |
| At startup the meter displays "Methods corrupted". | The method file was corrupted. | Contact the vendor. |

ELECTRODE CONDITIONING AND MAINTENANCE

STORAGE PROCEDURE

To assure a quick response time, the glass bulb should be kept moist and not allowed to dry out. Replace the solution in the protective cap with a few drops of HI 70300 or HI 80300 Storage Solution. Follow the Preparation Procedure section before taking measurements.

Note: NEVER STORE THE pH ELECTRODE IN DISTILLED OR DEIONIZED WATER.

PERIODIC MAINTENANCE

Inspect the electrodes and the cables. The cable used for connection to the instrument must be intact and there must be no broken insulation on the cable or cracks on the electrode stem or bulb. Connectors must be perfectly clean and dry. If any scratches or cracks are present, replace the electrode. Rinse off any salt deposits with distilled/deionized water.

pH CLEANING PROCEDURE

- *General* Soak in Hanna HI 7061 or HI 8061 General Cleaning Solution for approximately ½ hour.

IMPORTANT: After performing any of the cleaning procedures, rinse the electrode thoroughly with distilled or deionized water and soak the electrode in HI 70300 or HI 80300 Storage Solution for at least 1 hour before use. Recalibrate electrode before taking measurements.

ACCESSORIES

REAGENTS

- HI 84532-50 Titrant solution for Low Range (120 mL)
HI 84532-51 Titrant solution for High Range (120 mL)
HI 84532-55 Calibration Standard (230 mL)

pH CALIBRATION SOLUTIONS

- HI 7004M Buffer solution pH 4.01 (230 mL)
HI 7007M Buffer solution pH 7.01 (230 mL)
HI 70082M Buffer solution pH 8.20 (230 mL)
HI 7010M Buffer solution pH 10.01 (230 mL)

ELECTRODES

- HI 1131B pH Electrode
HI 7662-T Temperature probe

ELECTRODE FILL SOLUTION

- HI 7082 Fill solution for HI 1131B (4 x 30 mL)

ELECTRODE STORAGE SOLUTION

- HI 70300L Electrode storage solution (500 mL)

ELECTRODE CLEANING SOLUTION

- HI 7061M Electrode Cleaning Solution, 230 mL bottle

OTHER ACCESSORIES

- HI 70500 Tube set with cap for titrant bottle, tip and valve
HI 71005/8 115 Vac to 12 Vdc, 800 mA
HI 71006/8 230 Vac to 12 Vdc, 800 mA
HI 731319 Stir bar (10 pcs., 25 x 7 mm)
HI 740036P 100 mL Beaker (10 pcs.)
HI 740037P 20 mL Beaker (10 pcs.)
HI 740236 5 mL syringe for minititrator
HI 920013 PC Connection Cable

WARRANTY

HI 84532 is guaranteed for two years against defects in workmanship and materials when used for its intended purpose and maintained according to instructions. Electrodes and probes are guaranteed for six months. This warranty is limited to repair or replacement free of charge.

Damage due to accidents, misuse, tampering or lack of prescribed maintenance is not covered.

If service is required, contact your dealer from whom you purchased the instrument. If under warranty, report the model number, date of purchase, serial number and the nature of the problem. If the repair is not covered by the warranty, you will be notified of the charges incurred.

If the instrument is to be returned to Hanna Instruments, first obtain a Returned Goods Authorization number from the Technical Service department and then send it with shipping costs prepaid. When shipping any instrument, make sure it is properly packed for complete protection.

To validate your warranty, fill out and return the enclosed warranty card within 14 days from the date of purchase.

RECOMMENDATION FOR USERS

Before using this product, make sure that it is entirely suitable for your specific application and for the environment in which it is used.

Operation of this instrument may cause unacceptable interferences to other electronic equipment, thus requiring the operator to take all necessary steps to correct interferences.

Any variation introduced by the user to the supplied equipment may degrade the instrument's EMC performance.

To avoid damages or burns, do not put the instrument in microwave ovens. For your and the instrument's safety, do not use or store the instrument in hazardous environments.

Hanna Instruments reserves the right to modify the design, construction or appearance of its products without advance notice.



Hanna Instruments Inc.
Highland Industrial Park
584 Park East Drive
Woonsocket, RI 02895 USA

Technical Support for Customers

Tel. (800) 426 6287
Fax (401) 765 7575
E-mail tech@hannainst.com
www.hannainst.com

Local Sales and Customer Service Office

