

Original operating instructions

Refrigerator

Read the operating instructions before switching on for the first time

Page 14

EN

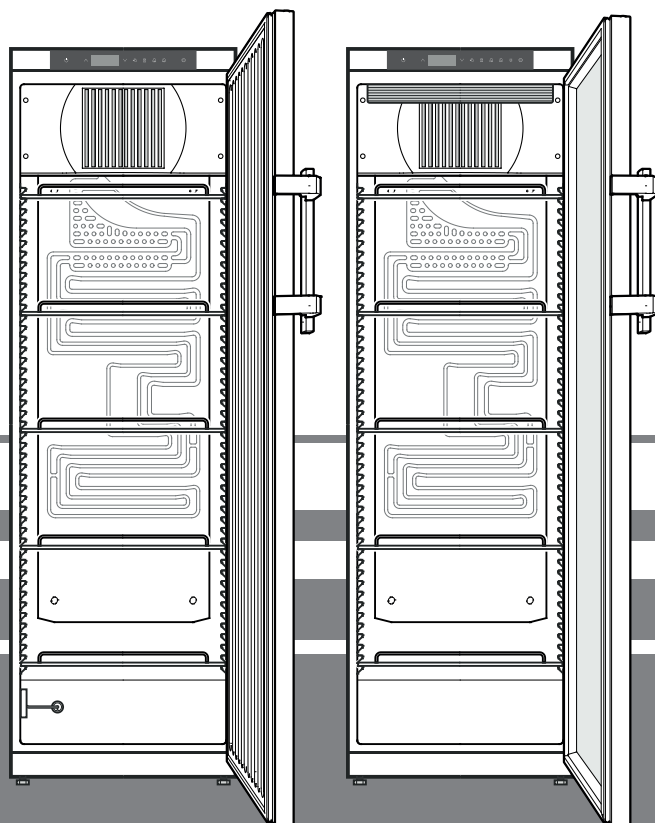

LKv 3910

LKv 3913

7085 920-01

LIEBHERR

Content

Priority of warnings.....	14
Safety instructions and warnings	14
Symbols on the appliance	15
Intended use.....	15
Foreseeable incorrect use.....	15
Declaration of conformity	15
Noise emissions from the appliance	16
Climate rating	16
Description of the appliance.....	16
Other features	16
Setting up	16
Levelling the appliance.....	16
Electrical connection.....	17
Operating and control elements	17
Switching the appliance on and off	17
Setting the temperature.....	17
Temperatur display mode.....	17
Door open alarm.....	18
Setting the delay time for the door open alarm.....	18
Audible warning signal settings.....	18
Deactivating the audible warning signal function	18
Alarm test	18
Alarm messages	19
Adjusting the alarm parameters	19
Calling up stored alarm events and reading the temperature progression.....	19
Resetting the stored alarm events HAN.....	19
Resetting the recorded temperature progression rt	19
Example of an alarm query	20
Calibrating the control sensor	20
Product sensor	20
Calibrating the product sensor	20
Switching the temperature display between control sensor and product sensor.....	21
Keypad lock.....	21
Setting the real time clock	21
Conversion from summer to winter time.....	21
Enabling/disabling automatic conversion from summer to winter time	22
Changing the network address	22
Resetting the parameters to factory settings	22
Safety lock.....	22
Interior light (LKv 3913).....	22
Defrosting.....	22
Setting the display indication for the defrost phase	22
Activating the defrost function manually	22
Cleaning	23
Disposal notes.....	23
Shutting your appliance down	23
Malfunctions.....	23
Possible error messages in the display.....	23
External alarm	24
Changing over door hinges	24

Priority of warnings

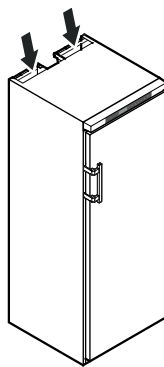

⚠ DANGER	identifies a situation involving direct danger which, if not obviated, may result in death or severe bodily injury.
⚠ WARNING	identifies a dangerous situation which, if not obviated, may result in death or severe bodily injury.
⚠ CAUTION	identifies a dangerous situation which, if not obviated, may result in minor or medium bodily injury.
NOTICE	identifies a dangerous situation which, if not obviated, may result in damage to property.
Note	identifies useful information and tips.

Safety instructions and warnings

- **WARNING:** do not seal ventilation openings on the appliance housing or enclosure. 
- **WARNING:** only use the mechanical devices or other aids recommended by the manufacturer to help speed up the defrosting process.
- **WARNING:** do not damage the refrigerant circuit.
- **WARNING:** do not use any electrical devices in the refrigerator compartment which do not comply with the design recommended by the manufacturer.
- **WARNING:** the mains cable must not be damaged while installing the appliance.
- **WARNING:** multi-sockets or distributor strips and other electronic devices (such as halogen transformers) must not be positioned and operated at the rear of appliances.
- **WARNING:** danger of injury through electric shock. There are live parts under the cover. Only have the interior LED light replaced or repaired by customer service staff or trained personnel.
- **WARNING:** risk of injury from the LED lamp. The light intensity of the LED light complies with laser class RG 2. If the cover is defective, do not look directly at the light through optical lenses from close distance. This may damage your eyes.
- **WARNING:** this appliance must be secured as described in the operating instructions to rule out any potential risks due to its instability.

- This appliance can be used by children of 8 years old and over, and also by persons with restricted physical, sensory or mental capacity or lack of experience and knowledge, if they are supervised or have been instructed on safe use of the appliance and understand the resulting risks. Children must not be allowed to play with the appliance. Cleaning and user maintenance must not be carried out by children without supervision.
- Do not store any explosive substances, such as aerosol containers with flammable propellant gas, inside the appliance.
- To prevent injury and damage to property, the appliance should only be installed by two people.
- After unpacking it, check the appliance for signs of damage. Contact the supplier if it is damaged. Do not connect the appliance to the mains power supply.
- Avoid prolonged skin contact with cold surfaces (e.g. chilled/frozen products). If necessary, take safety action (e.g. gloves).
- All repairs and work on the appliance may only be carried out by customer service personnel or other trained personnel. The same applies to changing the mains power cable.
- Only carry out repair and other work on the appliance when the mains plug has visibly been disconnected.
- Only install, connect and dispose of the appliance as described in these operating instructions.
- In the event of a fault, pull out the plug or switch off the fuse.
- When disconnecting the appliance from the mains, pull on the plug. Do not pull on the cable.
- Do not use the interior LED light to light the room. The interior LED light is only designed to illuminate the interior of the appliance.
- Do not allow naked flames or ignition sources to enter the appliance.

Symbols on the appliance

	The symbol can be located on the compressor. It refers to the oil in the compressor and indicates the following danger: swallowing or inhaling can be fatal. This is only relevant for recycling. There is no danger in normal operation.
	Warning about flammable substances.
	A sticker to this effect may be applied to the rear of the appliance. It refers to the foampadded panels in the door and/or the housing. This is only relevant for recycling. Do not remove the sticker.

Intended use

This universal laboratory refrigerator for professional use is suitable for storing products at temperatures between 3°C and 16°C.

Typical products for storage include research samples, reagents, laboratory inventory, etc.

For the storage of valuable or temperature-sensitive substances or products the use of an independent, constantly monitoring alarm system is necessary.

This alarm system must be designed so that each alarm status is detected immediately by an authorised person who can then take appropriate action.

Foreseeable incorrect use

Do not use the appliance for the following applications:

- Storage and cooling of
 - chemically unstable, inflammable or caustic substances
 - blood, plasma or other bodily fluids for the purposes of infusion, application or insertion into the human body.
- Use in potentially explosive atmospheres.
- Use outdoors or in areas where it is exposed to splash water or damp conditions.

Incorrect use of the appliance will result in damaging or spoiling the goods stored in it.

Declaration of conformity

The refrigerant circuit has been tested for leaks. The appliance complies with the relevant safety regulations and EU Directives 2006/42/EG, 2014/30/EU, 2009/125/EG and 2011/65/EU.

Noise emissions from the appliance

The noise level while the appliance is operating is below 70 dB(A) (relative noise level 1 pW).

Climate rating

The climate rating indicates at what room temperature the appliance may be operated to achieve full cooling capacity and what the maximum humidity level in the area around the appliance may be to ensure that no condensation forms on the exterior housing.

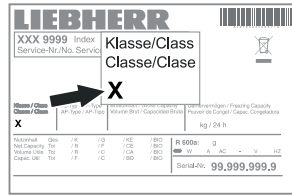

The climate rating is indicated on the type plate.

Climate rating	Max. room temperature	Max. relative humidity
3	25 °C	60%
4	30 °C	55%
5	40 °C	40%
7	35 °C	75%

The minimum room temperature at the place of installation is 10°C.

Description of the appliance

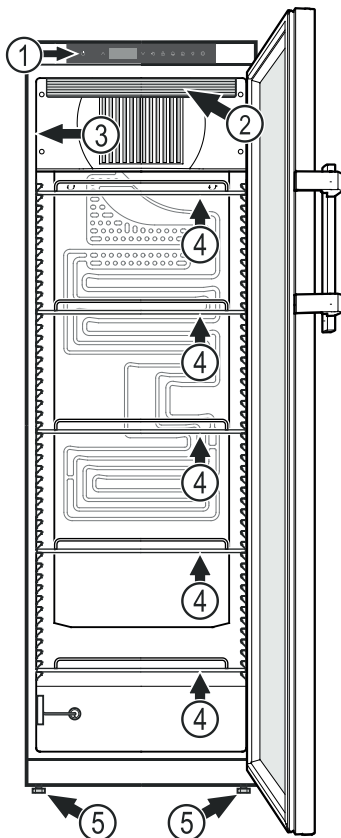

- (1) Operating and control elements
- (2) Interior light (LED light strip) (LKv 3913)
- (3) Type plate
- (4) Grid shelves
- (5) Adjustable-height feet

NOTICE

The maximum load per grid shelf is 45 kg.

Other features

- Audible and visual temperature alarm.
- Audible and visual door open alarm.
- Floating contact for connection to a remote monitoring system.
- Serial interface (RS485) for external temperature and alarm documentation.
- Maximum/minimum interior temperatures are stored.
- Last 3 temperature alarms are saved with time, date and duration of alarm.
- Last 3 power cuts are saved with time, date and duration of power cut.
- Safety thermostat to avoid temperatures below +2°C.

It is essential to use these safety facilities to avoid damage to stored items. These facilities must not be deactivated or decommissioned!

Setting up

- Do not place the appliance in direct sunlight or near radiators and similar sources of heat.
- The more coolant there is in the appliance, the larger the room in which the appliance is installed must be. If the room is too small, any leak may create a flammable mixture of gas and air. For each 8 g of coolant the installation space must be at least 1 m³. Information on the coolant is on the model plate inside the appliance.
- Always install the appliance directly against the wall.

Levelling the appliance

Compensate floor unevenness using the adjustable feet.

NOTICE

The appliance must be aligned horizontally and vertically. If the appliance is not level, the main body of the appliance can be deformed and the door will not close properly.

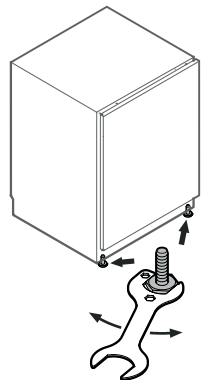

Appliance dimensions

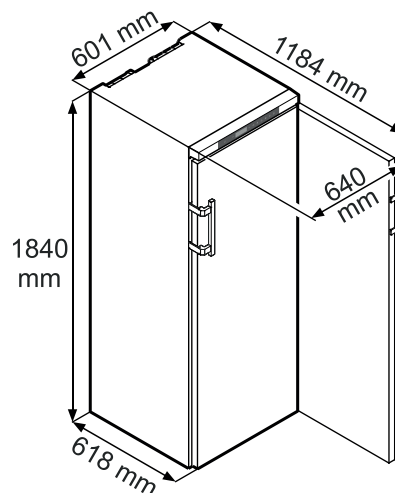

Electrical connection

Only operate the appliance with **alternating current (AC)**.

The permissible voltage and frequency are indicated on the type plate. The position of the type plate is shown in the section entitled **Description of the appliance**.

The socket must be properly earthed and protected by a fuse. The tripping current of the fuse must be between 10 A and 16 A.

The socket must not be situated behind the appliance and must be easily accessible.

Do not connect the appliance using an extension cable or extension socket.

Do not use stand-alone inverters (conversion of direct current to alternating current/three-phase current) or energy-saving plugs. Risk of damage to the electronic control system!

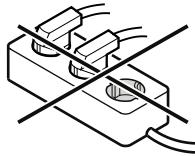

Operating and control elements

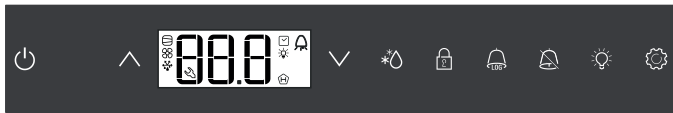

- On/Off button (switching the appliance on and off)
- Selection buttons
- Defrost button (for manually activating the defrost function)
- Keypad lock
- Button for calling up stored alarm events
- Audible alarm Off button
- Interior light on/off button (LKv 3913)
- Enter button

Symbols in the display

- Compressor is running
- LED flashing - refrigeration unit switches on after a delay. The compressor will start automatically after the pressure in the refrigerant circuit has equalised.
- Fan is running
- Appliance is defrosting
- Temperature display via product sensor is activated
- LED flashing and **E T C** appears in the display. The real time clock must be reset.
- The interior light is switched on
- The display means that the power supply and interior temperature of the appliance are recorded.
- If flashes in the display, there has either been a power failure or the temperature in the appliance exceeded the permissible range.
- Alarm function
- The appliance has suffered a fault. Contact the customer service department.

Switching the appliance on and off

Connect the appliance to the mains. Display = **OFF**.

Switching the appliance on

Press for approx. 5 seconds. Display = **ON**.

No alarm is displayed or sounded when the appliance is switched on for the first time.

If the appliance is disconnected from the mains for a long time after it has been switched on for the first time and if the temperature inside the appliance rises above the upper alarm limit, this will be detected as a fault by the electronic control system (flashes in the display).

When the appliance is switched on again, this display must be reset as shown below.

Press .

Press + for 5 seconds. Display = **r E S**

The LED will now light up permanently.

Press for 5 seconds.

The electronic control system will switch back to normal operating mode.

Switching the appliance off

Press for approx. 5 seconds. Display = **OFF**

Setting the temperature

Press for 1 second. The temperature display flashes.

To increase the temperature (warmer): press button .

To reduce the temperature (colder): press button .

Press again.

The desired temperature setting is saved.

Note

The temperature in the warmest area of the interior may be higher than the temperature setting.

If the door is left open for a lengthy period, the temperature in the appliance's compartments may rise dramatically.

Temperatur display mode

The temperature display can be switched between degrees Celsius and degrees Fahrenheit. Factory setting is degrees Celsius.

Press for 5 seconds. Display = **r¹S**

Press . Display = **|**

Use button or to select the desired setting.

0 = °C 1 = °F



Press . Display = **r¹S**

Press for 5 seconds.

The electronic control system will switch back to normal operating mode.

Door open alarm

When the door is opened, the LED  lights up and the temperature display begins to flash.

When the door has been left open for more than 60 seconds, the LED  begins to flash, and  and the temperature indication flash alternately in the display.

The audible warning signal sounds (unless the audible warning signal function has been deactivated).

If the door has to stay open for longer in order to insert items to be cooled, cancel the audible warning signal by pressing button .



Setting the delay time for the door open alarm

The time before the audible warning signal sounds after the door has been opened can be adjusted.

Press  for 5 seconds. Display = .

Press  until  appears in the display.

Press . Display = | Setting range = 1 - 5 minutes.

Use button  or  to select the desired setting.

Press . Display = .

Press  for 5 seconds.

The electronic control system will switch back to normal operating mode.

Audible warning signal settings

The audible warning signal will be muted for the current alarm after the button  has been pressed. Complete the following steps if you want the audible warning signal to reactivate automatically.

Press  for 5 seconds. Display = .

Press  until  appears in the display.

Press . Display = |

Press . Display = |



Press . Display = .

Automatic reactivation of the audible warning signal is now active.

The time before the audible warning signal sounds again must be set.

Press . Display = .

Press . Display = | Setting range = 1 - 120 minutes.

Use button  or  to select the desired setting.

Press . Display = .



Press  for 5 seconds.

The electronic control system will switch back to normal operating mode.



Deactivating the audible warning signal function

The audible warning signal function can be completely deactivated if necessary.

Press  for 5 seconds. Display = .



Press  until  appears in the display.

Press . Display = |

Use button  or  to select the desired setting.

0 = audible warning signal function activated

1 = audible warning signal function deactivated

Press . Display = .

Press  for 5 seconds.



The electronic control system will switch back to normal operating mode.

Alarm test

This test checks the function of the internal and any external connected alarm device.

The appliance does not stop its refrigerating function during this test.

Press  +  for 5 seconds.

- The display will change to a temperature value of 0.2°C below the set upper alarm limit.
- The temperature value will now rise by 0.1°C every 2 seconds.
- When the upper alarm limit is reached,  will appear in the display. An external alarm unit connected to the floating alarm output will now be activated.
- The temperature value will continue to rise up to 0.2°C above the upper alarm limit.
- The same process will take place automatically for the lower alarm limit.  will appear in the display.

The LED  will be lit during the test.

The electronic control system will switch back to normal operating mode.

Cancelling the test prematurely

Press  for 5 seconds.

Note

If the values of the upper and lower alarm limit (**AL** and **AH** in the section entitled "**Adjusting the alarm parameters**") are set to **0**, **H**- - and **L**- - will appear in the display during this test.

Note

For a realistic temperature alarm test, an additional delay time (60 minutes) applies as well as the adjustable alarm parameters **AL**, **AH** and **Ad**.

After a door has been opened or a defrosting process, the alarm delay **Ad** will be extended by an additional delay time (60 minutes). This additional delay time must not be changed.

This means that a temperature alarm will appear later after a door has been opened or a defrosting process than is actually set using parameter **Ad**.

Alarm messages

1. LED flashes in the display

If  appears in the display, the appliance has a fault. Consult your nearest customer service point.

2. LED flashes in the display; the display reads HI or LO

The interior is too warm (HI) or too cold (LO).

The audible warning signal sounds (unless the audible warning signal function has been deactivated).

Note

The alarm parameters can be adjusted. See **Adjusting the alarm parameters**.

3. HA / HF / flashes in the display

There has been a power cut (HF) of some length or the interior was too warm or too cold (HA) during a certain period of time.

Up to three alarm events can be stored and called up.

Adjusting the alarm parameters

The alarm limits (difference to the set temperature) and the alarm delay (delay until alarm sounds) can be adjusted.

Note



After a door has been opened or a defrosting process, the alarm delay Ad will be extended by an additional delay time (60 minutes). This additional delay time must not be changed. This means that a temperature alarm will appear later after a door has been opened or a defrosting process than is actually set using parameter Ad.

Press  for 5 seconds. Display = r¹5

Press  until rL appears in the display.

rL = Lower alarm limit

Press . Display = temperature difference in °C



Use button  or  to select the desired setting.

Set positive values only.

Press . Display = rL

Press . Display = rH Upper alarm limit

Press . Display = temperature difference in °C

Use button  or  to select the desired setting.

Set positive values only.

Press . Display = rH

Press . Display = rD

Press . Display = alarm delay in minutes

Use button  or  to select the desired setting.



Press . Display = rD

Press  for 5 seconds.

The electronic control system will switch back to normal operating mode.

Calling up stored alarm events and reading the temperature progression

Press . Display = HAn

Scroll through the list using  or .

HAn Number of temperature alarms

HA Last temperature alarm

HA | Last temperature alarm but one

HA² Temperature alarm before HA |

HF n Number of power cuts

HF Last power cut

HF | Last power cut but one

HF² Power cut before HF |

r t Period in hours in which the maximum and minimum interior temperatures were measured

r H Maximum (highest) measured temperature

r L Lowest measured temperature

Select the required item using the  button. Press this button again to return to the list.

You can exit the menu at any time by pressing  for 5 seconds.

If no button is pressed within 60 seconds, the electronic control system switches back automatically.

Resetting the stored alarm events HAn

Press . Display = HAn

Press  +  for 5 seconds. Display = r¹5.

Press  for 5 seconds.

The electronic control system will switch back to normal operating mode.

Resetting the recorded temperature progression rt

Press . Display = HAn

Press the button  or  until r t appears in the display.

Press . Display = 0 - 999

Press  for 5 seconds. Display = r¹5.

The values for r H and r L (highest and lowest measured interior temperature) are then reset to the current interior temperature.

Press  for 5 seconds.

The electronic control system will switch back to normal operating mode.

Example of an alarm query

Situation: HA/HF/  flashes in the display.

Press . Display = HF r

Press . Display = 0

There has not been an alarm status with a too high or too low temperature. You must switch to display HF r.

Press . Display = HF r

Press  until HF r appears in the display.

Press . Display = 1 power failure has occurred.

Press . Display = HF r

Press . Display = HF Last power failure.

Press . Display = 400 (year)

Press . Display = 000 (month 1-12)

Press . Display = 000 (day 1-31)

Press . Display = 000 (hour 0-23)

Press . Display = 000 (minute 0-59)

Press . Display = 000 (period of time in minutes)

Press  +  for 5 seconds. Display = r E 5

The  LED will now light up permanently.

HA/HF is cancelled in the display.

The electronic control system is now ready for the next alarm.

Press  for 5 seconds.

The electronic control system will switch back to normal operating mode.

Calibrating the control sensor



(standard sensor for temperature control)

Possible tolerances of the control sensor (the displayed temperature compared to the actual interior temperature) can be offset with this function.

Press  for 5 seconds. Display = r E 5

Press  until r E 1 appears in the display.

Press . Display = correction value set at the factory

Use button  or  to increase or decrease the correction value in 0.1°C increments.

Press . Display = actual (corrected) interior temperature

Press . Display = r E 1

Press  for 5 seconds.

The electronic control system will switch back to normal operating mode.

Product sensor

The product sensor in the bottom area of the appliance interior is an additional sensor for temperature indication.

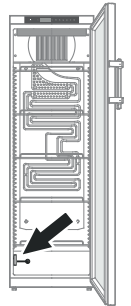



Calibrating the product sensor

Possible tolerances of the product sensor (the displayed temperature compared to the actual interior temperature) can be offset with this function.

Press  for 5 seconds. Display = r E 5

Press  until r E 3 appears in the display.

Press . Display = 0.0

Use button  or  to increase or decrease the correction value in 0.1°C increments.

Press . Display = actual (corrected) product sensor temperature

Press . Display = r E 3

Press  for 5 seconds.

The electronic control system will switch back to normal operating mode.

Switching the temperature display between control sensor and product sensor

Press  for 5 seconds. Display = r¹5

Press  until r¹ε| appears in the display.

Press . Display = | (control sensor)

Press . Display = ε² (product sensor)

If the product sensor is activated,  appears in the display.

Press . Display = r¹5

Press  for 5 seconds.

The electronic control system will switch back to normal operating mode.

Keypad lock



The keypad lock ensures that no unintentional changes are made to the electronic control system.

Setting a PIN code for the keypad lock function

Press  for 5 seconds. Display = r¹5

Press  until P | appears in the display.

Press . Display = |

Use button  or  to choose a PIN code between 1 and 999.

Press . Display = P |

Press  for 5 seconds.

The electronic control system will switch back to normal operating mode.

Activating the keypad lock

Press  for 5 seconds. Display = |

Use button  or  to select the PIN code.

Press . Display = |00ε

All buttons except  and  are locked.

If an incorrect PIN code is entered, the electronic control system switches back to normal operation without activating the keypad lock.

Deactivating the keypad lock

Press  for 5 seconds. Display = |

Use button  or  to select the PIN code.

Press . Display = u00|

All functions are enabled.

If an incorrect PIN code is entered, the keypad lock remains active.

Setting the real time clock

The real time clock is preset (CET). For a different time zone, the time must be adjusted manually.

Press  for 5 seconds. Display = r¹5

Press . Display = ε ε



Press . Display = 900 (year)

Press . Display = 00

Set the year by pressing the   buttons. Press .

Press . Display = 000 (month 1-12)

Press . Display = 00

Set the month by pressing the   buttons. Press .



Press . Display = 000 (day 1-31)

Press . Display = 00

Set the day by pressing the   buttons. Press .



Press . Display = 000 (days of the week)
(1 = Monday, 7 = Sunday)

Press . Display = 00

Set the day of the week by pressing the   buttons. Press .



Press . Display = 000 (hour 0-23)

Press . Display = 00

Set the hour by pressing the   buttons. Press .

Press . Display = 000 (minute 0-59)

Press . Display = 00

Set the minutes by pressing the   buttons. Press .

Press  for 5 seconds.

The electronic control system will switch back to normal operating mode.

When ε ε ε appears in the display, the real time clock must be reset.

Conversion from summer to winter time

Conversion to summer time is carried out automatically by the electronic control system on the last Sunday in March at 2 o'clock in the morning.

Conversion to winter time is carried out automatically by the electronic control system on the last Sunday in October at 2 o'clock in the morning.



In order to enable the new time, the appliance must be switched off and on after each of the times specified above.

Enabling/disabling automatic conversion from summer to winter time

Press  for 5 seconds. Display = r15

Press  until  appears in the display.

Press . Display = |

Use button  or  to select the desired setting.

0 = deactivated 1 = activated

Press . Display = d5E

Press  for 5 seconds.

The electronic control system will switch back to normal operating mode.



Changing the network address

When connecting several appliances via the RS485 interface, each appliance must have its own network address.

Press  for 5 seconds. Display = r15

Press  until  appears in the display.

Press . Display = |

Use button  or  to change the network address (1-207).

Press . Display = H0

Press  for 5 seconds.

The electronic control system will switch back to normal operating mode.

Resetting the parameters to factory settings

The alarm limits and sensor calibration values can be reset to the factory settings using this function.

Pull out the mains plug.

Keep  pressed and connect the mains plug.

Display = b11

Press . Display = 5t d

The electronic control system will switch back to normal operating mode.

Safety lock

The lock in the appliance door is equipped with a safety mechanism.

Locking the appliance

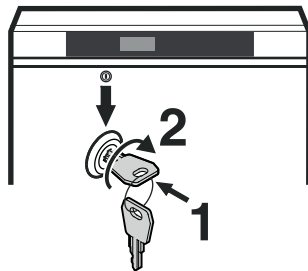

- Insert the key as shown by arrow 1.
- Turn the key 90°.

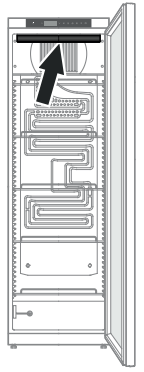

To unlock the appliance, the same procedure must be repeated in the same order.

Interior light (LKv 3913)





The interior light can be switched on and off using the  button. Keep the button  pressed for approx. 3 seconds.

Defrosting



The appliance defrosts automatically.



Setting the display indication for the defrost phase

Press  for 5 seconds. Display = r15

Press  until  appears in the display.

Press . Display = |

Use button  or  to select the desired setting.

0 = Symbol  + alternating display of  and the current temperature in the interior of the appliance.

1 = Symbol  + temperature before the start of the defrost phase.



2 = Symbol  + .

Press . Display = dF

Press  for 5 seconds. The electronic control system will switch back to normal operating mode.

Activating the defrost function manually

If the door has been left slightly open for a long time, a layer of ice may form in the interior and on the cooling plate. The defrost function can then be activated manually.

Press  for 3 seconds. Display =  + 

The electronic control system will automatically switch back to normal operating mode.

Display = 

Cleaning

⚠ WARNING

Before cleaning, always disconnect the appliance from the mains. Pull out the plug or switch off the fuse.

⚠ CAUTION

Risk of damage to the appliance components and risk of injury due to hot steam.

Do not use steam cleaning equipment to clean the appliance.

NOTICE

All surfaces in the appliance must be cleaned at regular intervals!

- Clean the inside, equipment parts and outer walls with lukewarm water and a little detergent. Do not use chemical solvents or any cleaning agents containing sand or acid.
- To avoid short-circuits, ensure no cleaning water penetrates into the electrical components when cleaning the appliance.
- Dry all parts well with a cloth.
- The dust should be removed from the refrigeration unit and heat exchanger - metal grid at the back of the appliance - once a year.
- Do not damage or remove the type plate on the inside of the appliance. It is very important for servicing purposes.

Disposal notes

The appliance contains reusable materials and should be disposed of properly - not simply with unsorted household refuse. Appliances which are no longer needed must be disposed of in a professional and appropriate way, in accordance with the current local regulations and laws.



Do not damage the refrigerant circuit of an appliance that is no longer needed during its disposal.

This appliance contains inflammable gases in the refrigerant circuit and insulation foam.

Your local council or a waste disposal contractor can provide information about how to dispose of the appliance correctly.

Shutting your appliance down

If the appliance is left empty for a lengthy period, it must be switched off, defrosted, cleaned and dried and the door is to be left open to prevent mould formation.

Malfunctions

You may be able to rectify the following faults by checking the possible causes yourself:

- **Appliance does not function:**
 - Is the appliance switched on?
 - Is the plug correctly fitted in the mains socket?
 - Is the fuse intact?
- **The temperature is not low enough:**
 - Is the temperature setting correct (see "Setting the temperature")?
 - Does the separately installed thermometer show the correct reading?
 - Is the ventilation system working properly?
 - Is the appliance set up too close to a heat source?
- **Temperature alarm test does not work as required.**
 - See „Alarm test“ and „Adjusting the alarm parameters“

If none of the above causes apply and you cannot rectify the fault yourself, contact the nearest customer service department stating the type designation ①, service number ② and appliance number ③ as indicated on the type plate.

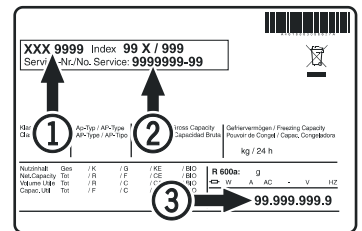

The position of the type plate is shown in the section entitled **Description of the appliance**.

Possible error messages in the display

Error code	Error	Action
E0, E1, E2, rE	Temperature sensor defective	Contact the customer service department
EE, EF	Electronic control system error	Contact the customer service department
dOr	Appliance door open for too long	Close appliance door
HI	Temperature inside appliance too high (too warm)	Check that the door has been closed properly. If the temperature does not drop, contact the customer service department.
LO	Temperature inside appliance too low (too cold)	Contact the customer service department
Etc		Reset the real time clock (see "Setting the real time clock")
HF, HA	There has been a power cut of some length or the interior was too warm or too cold during a certain period of time.	See Calling up stored alarm events and reading the temperature progression
AFr	Temperature around the product sensor < 0°C	Contact the customer service department

External alarm

There are various connection options at the back of the appliance.

The appliance may only be connected to an external alarm device by trained personnel.

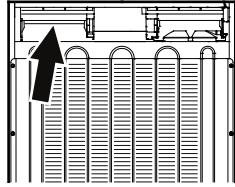

Note

The connectors are secured with screws. To remove the connectors, undo the left and right screws.

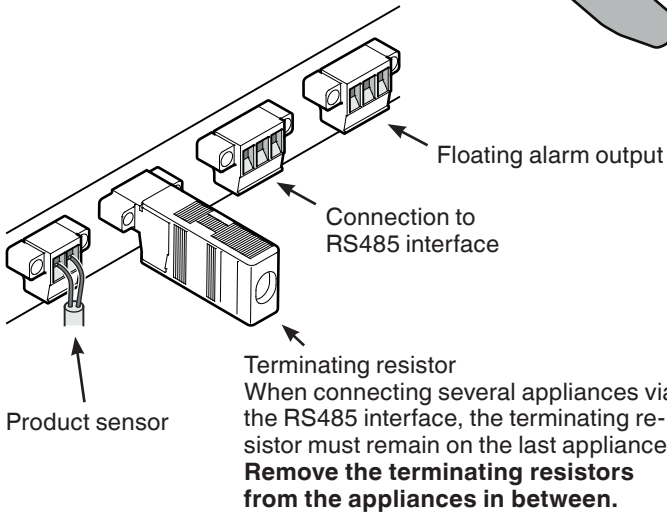
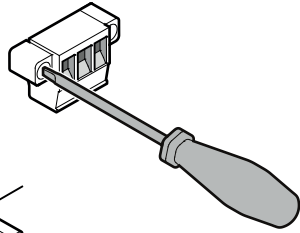

Floating alarm output

These three contacts can be used to connect the appliance to an optical or acoustic alarm device. The connection is designed for a maximum of **42 V/8 A DC** from a safety extra-low voltage (SELV) source (**minimum current: 150 mA**).

Notice

When supplying mains voltage to the floating alarm contact, the technical safety requirements of standard EN 60335 will not be satisfied.

N.O

Connection for a visual warning light or an acoustic alarm signal.

N.C

Connection for a control lamp to indicate that the appliance is in normal mode.

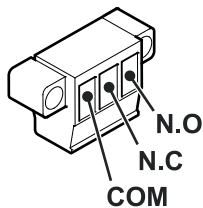

COM

External power supply unit, 42 V/8 A DC maximum, Minimum current: 150 mA

RS485 interface

Rx- / Tx- Send/Receive data cable (negative pole)

Rx+ / Tx+ Send/Receive data cable (positive pole)

GND Earth cable

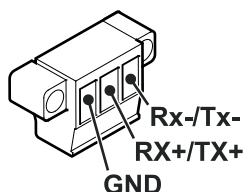

Changing over door hinges

1. Unscrew the hinge bracket.

Note

The door mounting has a spring mechanism enabling the door to close by itself. The hinge bracket turns to the left when the screws are undone.

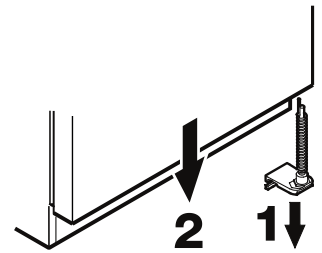

2. Pull the door out at the bottom and lift off.

3. Transfer plugs to the other side.

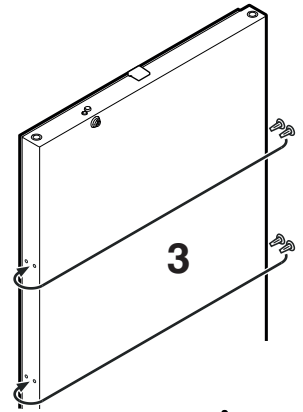

4. Transfer pin on hinge bracket to the opposite side.

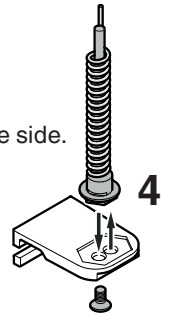

5. Transfer upper hinge components to the opposite side.

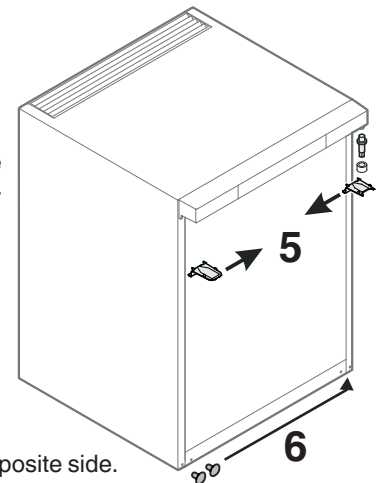

6. Transfer covers to the opposite side.

7. Mount door on hinge pin and close.

8. Insert hinge bracket in lower door mounting. Turn hinge bracket by 90° - spring is compressed. Screw on hinge bracket.

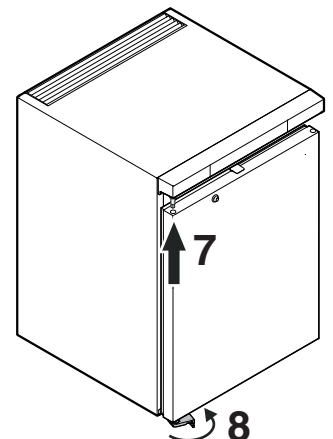

9. Screw on the handle.

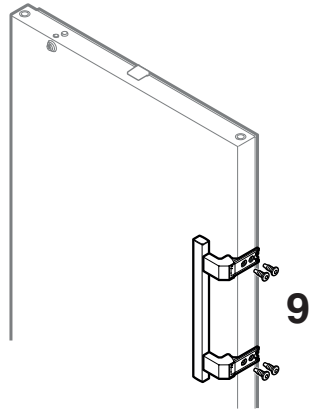

10. Push on pressure plates until they engage.

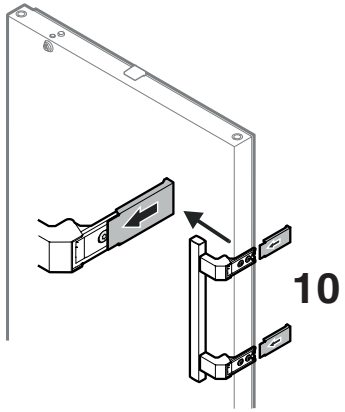



Liebherr-Hausgeräte GmbH
Memminger Straße 77-79
88416 Ochsenhausen
Germany
home.liebherr.com

