

# Cole-Parmer<sup>®</sup>

## Integrity 10 Reaction Station

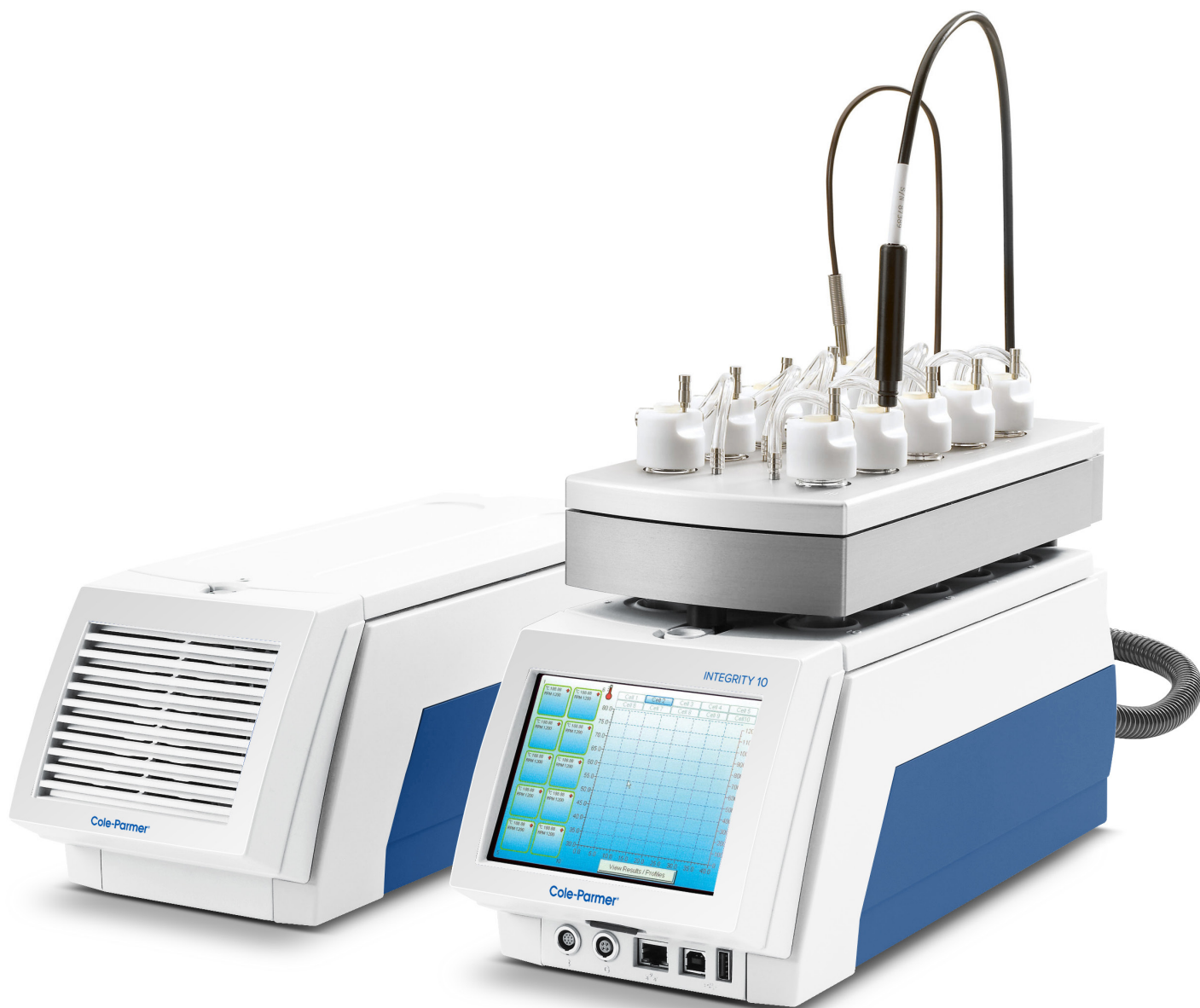

Instruction Manual  
M8024-CPB Version 6.2

**Cole-Parmer<sup>®</sup>**  
essentials



<b>1. Symbols and using this instruction book.....</b>	<b>5</b>
<b>2. Safety.....</b>	<b>6</b>
2.1. Safety information.....	6
2.2. Consignes de sécurité.....	8
2.3. Sicherheitsinformationen.....	11
2.4. Información de seguridad.....	14
2.5. Informazioni sulla sicurezza.....	16
<b>3. Introduction.....</b>	<b>20</b>
3.1. Instrument specification.....	21
<b>4. Unpacking and contents .....</b>	<b>22</b>
<b>5. Installation .....</b>	<b>23</b>
<b>6. Environmental protection .....</b>	<b>26</b>
6.1. Battery disposal.....	26
<b>7. Product operation .....</b>	<b>27</b>
7.1. Product overview.....	27
7.2. Reduction sleeves - fitting and removal.....	28
7.3. Insert SD card.....	30
7.4. Turn unit ON.....	30
7.5. Turn unit OFF.....	30
7.6. Power up.....	31
7.7. Time and date setting.....	32
7.8. Communication protocol selection (for use with external control).....	33
7.9. View firmware release set.....	34
7.10. Manual control.....	35
7.10.1. Setting the temperature.....	36
7.10.2. Setting the stir speed:.....	37
7.10.3. Setting the run time.....	37
7.10.4. Setting the ramp rate.....	37
7.10.5. Setting the maximum upper limit.....	38
7.10.6. Copy function.....	38
7.10.7. Adjusting the settings of a running cell in manual control.....	39
7.10.8. Home screen when operational.....	40
7.11. Profile control.....	41
7.11.1. Profile set up.....	41
7.11.2. Setting the initial temperature.....	42
7.11.3. Setting the initial hold time.....	42
7.11.4. Setting the initial ramp.....	43
7.11.5. Setting the target temperature.....	43
7.11.6. Setting the maximum upper limit.....	44
7.11.7. Setting the plateau time.....	44













7.11.8.	Final temperature .....	45
7.11.9.	Final ramp .....	46
7.11.10.	Setting the hold time.....	46
7.11.11.	Stir speed .....	47
7.11.12.	Ramp loop .....	47
7.11.13.	Copy and paste a profile.....	48
7.11.14.	In the event of power loss .....	49
7.12.	Naming and saving a profile .....	49
7.13	Stored profile view and copy .....	51
7.13.1.	Storing a profile.....	51
7.13.2.	Delete a stored profile .....	54
7.14.	Saving an experiment .....	55
7.15.	Reviewing stored experiment data.....	57
7.15.1.	Accessing stored experiment data.....	57
7.15.2.	Viewing data in graphical format.....	59
7.15.3.	Deleting experimental data.....	60
7.16.	Outputting stored data via USB flash drive .....	60
7.17.	Control by contents.....	61
7.17.1.	Installation of the multitemp .....	61
7.17.2.	Operating the multitemp.....	62
7.18.	External control – optional.....	63
7.18.1.	PC control: .....	63
<b>8.</b>	<b>Chemical resistance.....</b>	<b>64</b>
<b>9.</b>	<b>Dimensions (unit).....</b>	<b>70</b>
<b>10.</b>	<b>Power supply unit (PSU) specifications .....</b>	<b>71</b>
<b>11.</b>	<b>Maintenance, service and repair.....</b>	<b>72</b>
11.1.	Maintenance .....	72
11.2.	Spillage procedure .....	73
11.3.	Decontamination.....	73
11.4.	Servicing.....	73
11.5.	Error and warning messages.....	73
11.5.1.	Heat exchanger over temperature error .....	74
11.5.2.	Motor stall error .....	75
11.5.3.	Cell failure error .....	75
11.5.4.	Over voltage error .....	76
11.5.5.	Under Voltage error.....	76
11.5.6.	Probe error .....	77
<b>12.</b>	<b>Customer support .....</b>	<b>78</b>
<b>13.</b>	<b>Spares and accessories .....</b>	<b>79</b>
<b>14.</b>	<b>Notes.....</b>	<b>80</b>
<b>15.</b>	<b>Declaration of conformity .....</b>	<b>82</b>
<b>APPENDIX 'A'</b>	<b>.....</b>	<b>83</b>

# 1. Symbols and using this instruction book

Throughout this instruction book the symbols defined below are used to identify conditions that pose a hazard to the user or actions that should be observed. These symbols are also shown on the product or its packaging. When a symbol is shown next to a paragraph or statement it is recommended the user takes particular note of that instruction in order to prevent damage to the equipment or to prevent injury to one's self or other people.

**The Responsible Body and the Operator should read and be familiar with this Instruction book in order to preserve the protection offered by the equipment.**

**To prevent injury or equipment damage it is the manufacturer's recommendation that all persons using this equipment are suitably trained before use.**

	Caution, risk of danger. See note or adjacent symbol.
	Protective conductor terminal to be earthed. <b>Do not loosen or disconnect.</b>
	Caution / Risk of electric shock.
	Recyclable Packaging Material.
	Do not dispose of product in normal domestic waste.
	Caution. Hot surface.
	Bio Chemical Hazard. <b>Caution required. Will require decontamination.</b>
	Contains CR2032 button coin battery. <b>To be disposed of according to regulations - not customer serviceable.</b>
	Refer to Instruction manual.
	Port communication symbol.
	Cooling fluid. Connect inlet supply to Left hand side connector
	Cooling fluid. Connect inlet supply to Right hand side connector
	Standby

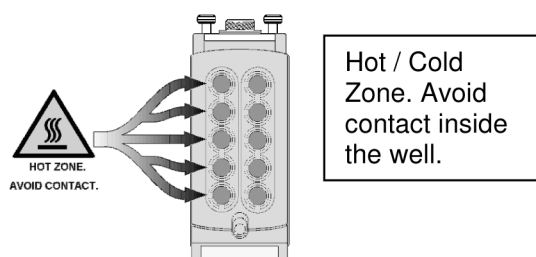





## 2. Safety

### 2.1. Safety information





This product has been designed for safe operation when used as detailed in accordance with the Manufacturer's instructions.





















**NOTE:** Failure to use this equipment in accordance with the manufactures operating instructions may compromise your basic safety protection afforded by the equipment and may invalidate the warranty/guarantee. The warranty/guarantee does not cover damage caused by faulty installation or misuse of the equipment.

#### Prevention of Fire and Electric Shock

	To prevent a risk of fire or electric shock, <b>DO NOT</b> open the <b>Integrity PSU</b> case without authorisation. Only qualified Service personnel should attempt to repair/service the PSU.
	Ensure the Mains Power Supply conforms to ratings found on the data plate located on the underside of the PSU.
	<b>Never</b> Operate this equipment without connection to earth/ground. Ensure the mains supply voltage is correctly earthed/grounded in accordance with current area legislation.
	<b>Do not</b> position the <b>Integrity 10</b> on top of the <b>Power Supply Unit</b>
	In the event of a single fault condition causing a cell within the unit to go over-temperature, there is additional protection within the cell in the form of a <b>Thermal Fuse</b> .  The Thermal Fuse is designed to protect a faulty cell continually heating beyond a temperature of approx. 190°C.  The Thermal Fuse is <b>not</b> designed to protect individual samples being heated beyond a specified temperature; additional means should be employed if that level of protection is required.

#### General Safe Operating Practice

	Always follow good laboratory practice when using this equipment. Give due recognition to your company's safety and legislative health & safety procedures and all associated legislation applicable to your areas of operation. Check laboratory procedures for substances being heated and ensure all hazards (e.g. risk of explosion, implosion or the release of toxic or flammable gases) that might arise have been suitably addressed before proceeding. When heating certain substances the liberation of hazardous gases may require the use of a fume cupboard or other means of extraction. <b>(Consult your company practice).</b>
	Ensure equipment is used on a clean, dry, non-combustible, solid work surface with at least 300mm of suitable clearance all around from other equipment.
	Ensure the PSU is positioned on a clean, dry, non-combustible surface with a sufficient space for the power cable to <b>Integrity 10</b> and mains input lead and plug set to enter/exit without undue bend stresses. Ensure a suitable clearance for air flow and heat dissipation.
	<b>Do not</b> position the <b>Integrity 10 or Power Supply Unit</b> so that it is difficult to connect/disconnect from the power cable assembly.
	<b>Do not</b> position the <b>Integrity 10 or Power Supply Unit</b> so that it is difficult to connect/disconnect from the coolant fluid supply.

	<b>Do not</b> position the <b>Integrity 10 or Power Supply Unit</b> so that it is difficult to connect/disconnect data and communication cables.
	<b>Do not</b> position the PSU so that the on/off switch or IEC mains socket located on the rear is inaccessible.
	<b>Do not</b> immerse any part of this equipment in water/fluid.
	<b>Do not</b> spill substances on the touch screen. Case materials are protected as defined in Table 8.1 Chemical resistance chart. If spillage does occur, disconnect unit from mains supply and follow instructions as detailed in Section 'Maintenance, Service and Customer Repair'.
	<b>Do not</b> cover the Integrity 10 or PSU ( <b>ESPECIALLY VENTILATION SLOTS</b> ) whilst in use.
	It is <b>not</b> recommended to leave any heating apparatus unattended during operation.
	Only use Original Equipment Manufacture's Parts and Accessories. Ref Section 11.
	The equipment is not spark, flame or explosion proof and has not been designed for use in hazardous areas in terms of BSEN 60079-14:1997. Keep flammable, low flash point substances away from the apparatus.
	<b>Do not</b> operate or handle any part of this product with wet hands.
 	<b>Do not</b> touch the inside of the cells when the product is in operation. <b>Take care when handling HOT &amp; COLD glassware</b>
 	Ensure the unit has reached ambient temperature before removing the top cover.
	When the top cover has been removed and the inside of the unit is exposed do not put fingers into the front or rear of the unit as there is the risk that they can become trapped.
	<b>Do not</b> lean or stretch over the unit when in operation.
	Keep the Mains Plug and Lead set cable away from the heating surface.
	<b>Touch Screen Warning.</b> The screen is impervious to acetone. It is recommended that any chemical spillage is wiped off the screen immediately.
	<b>Warning:</b> Standard glassware supplied for the Integrity product is not designed for high pressure applications. Maximum operating pressure of standard glassware with cap fitted is 0.5bar.
	<b>Warning:</b> Glass vessels can explode or implode violently, either spontaneously from stress failure caused by pressure or vacuum, or from accidental impact. Carefully check glass vessels for star cracks, scratches or etching marks before each use. Cracks can increase the likelihood of breakage or may allow chemicals to leak into the equipment. Conduct all pressure and vacuum operations in glass vessels behind adequate shielding and use Personnel Protective Equipment (Full face guard, gloves, protective clothing) during handling.
	<b>Warning:</b> Glass vessels which have been located in a block at a high temperature should not be placed into a cold block as this is likely to shatter the vessel.
	<b>Care must be taken</b> when using flammable solvents. Approaches which could be adopted to reduce the risk of fire include introducing an inert atmosphere inside of the reaction tubes and/or using the equipment in a properly ventilated area, e.g. under a fume hood.

## Additional safety information





ATS20002 and ATS20003 PTFE caps	For individual components see below.
Viton (main seal) and O rings	Viton is resistant to a wide range of chemicals including oils, aqueous media and most other fluids. It is recommended that the user checks the chemical compatibility prior to use.
PTFE Cap	PTFE is resistant to a wide range of chemicals including ozone, chlorine, acetic acid, ammonia sulphuric acid and hydrochloric acid. The only chemicals known to affect these coatings are molten alkali metals and highly reactive fluorinating agents. It is recommended that the user checks the chemical compatibility prior to use.
Silicone Cap Septum	Peroxide cross linked HTV silicone rubber, classified in accordance with ASTM D 1418 as VMQ. It is recommended that the user checks the chemical compatibility prior to use.
316 Stainless steel 2mm dia sampling hole bung	It is recommended that the user checks the chemical compatibility prior to use.
PTFE sampling hole bung	PTFE is resistant to a wide range of chemicals including ozone, chlorine, acetic acid, ammonia sulphuric acid and hydrochloric acid. The only chemicals known to affect these coatings are molten alkali metals and highly reactive fluorinating agents. It is recommended that the user checks the chemical compatibility prior to use.

## 2.2. Consignes de sécurité

Ce produit a été conçu pour fonctionner en toute sécurité lorsqu'il est utilisé conformément aux instructions du fabricant.

**REMARQUE :** Ne pas utiliser ce matériel en conformité avec les instructions de fonctionnement du fabricant peut compromettre la protection de sécurité de base offerte par ce matériel et peut annuler la garantie. La garantie ne couvre pas les dommages causés par une mauvaise installation ou une mauvaise utilisation du matériel.













### Prévention des incendies et des chocs électriques

	Pour éviter tout risque d'incendie ou de choc électrique, <b>N'OUVREZ PAS</b> le <b>bloc d'alimentation Integrity</b> sans autorisation. Seul du personnel de maintenance qualifié peut tenter de réparer ou d'entretenir le bloc d'alimentation.
	Veillez à ce que l'alimentation électrique du secteur soit conforme aux classes figurant sur la plaque signalétique située sur la partie inférieure du bloc d'alimentation.
	<b>Ne jamais</b> faire fonctionner le matériel sans mise à la terre/masse. Veillez à ce que la tension du secteur soit correctement mise à la terre/masse conformément à la législation en vigueur dans votre pays.
	<b>Ne</b> placez pas l' <b>Integrity 10</b> au dessus du <b>bloc d'alimentation</b>
	En cas de défaillance causant la surchauffe d'une cellule de l'appareil, il existe une protection supplémentaire à l'intérieur de la cellule sous la forme d'un <b>fusible thermique</b> .  Le fusible thermique est conçu pour protéger une cellule défectueuse continuant à chauffer au delà de 190 °C environ.



	Le fusible thermique <b>n'est pas</b> conçu pour protéger des échantillons individuels qui seraient chauffés au delà d'une température spécifique ; des moyens supplémentaires doivent être utilisés si ce niveau de protection est nécessaire.
--	---

### Pratiques de base pour une utilisation sûre

	Suivez toujours les bonnes pratiques de laboratoire lors de l'utilisation de cet appareil. Portez une attention particulière aux procédures de santé et de sécurité de votre entreprise et aux procédures réglementaires, ainsi qu'à toutes les lois applicables associées en vigueur dans votre pays. Vérifiez les procédures de laboratoire pour connaître les substances qui sont chauffées et veillez à ce que tous les dangers (par exemple le risque d'explosion, d'implosion et de dégagement de gaz toxiques ou inflammables) qui peuvent survenir ont été convenablement traités avant de poursuivre. Lorsque certaines substances sont chauffées, le dégagement de gaz dangereux peut nécessiter l'utilisation d'une hotte aspirante ou d'autres moyens d'extraction. <b>(Consultez les pratiques de votre entreprise).</b>
	Veillez à ce que le matériel soit utilisé sur une surface propre, sèche, incombustible et solide avec un espace suffisant d'au moins 300 mm tout autour du matériel.
	Veillez à ce que le bloc d'alimentation soit placé sur une surface propre, sèche et incombustible avec suffisamment d'espace afin que le câble d'alimentation allant vers l' <b>Integrity 10</b> et l'ensemble des câbles et fiches secteur puissent être insérés ou sortis sans être pliés de manière excessive. Veillez à maintenir un espace suffisant pour la circulation d'air et la dissipation de la chaleur.
	<b>Ne placez pas l'Integrity 10 ou le bloc d'alimentation</b> de sorte qu'il soit difficile de raccorder ou de débrancher l'ensemble des câbles d'alimentation.
	<b>Ne placez pas l'Integrity 10 ou le bloc d'alimentation</b> de sorte qu'il soit difficile de raccorder ou de débrancher l'alimentation en fluide de refroidissement.
	<b>Ne placez pas l'Integrity 10 ou le bloc d'alimentation</b> de sorte qu'il soit difficile de raccorder ou de débrancher les câbles de transfert de données et de communication.
	<b>Ne placez pas</b> le bloc d'alimentation de sorte que le commutateur marche/arrêt ou la prise secteur CEI situés à l'arrière soient inaccessibles.
	<b>Ne</b> plongez pas de pièces de cet appareil dans de l'eau ou dans un fluide.
	<b>Ne</b> renversez pas de substances sur l'écran tactile. Les matériaux du boîtier sont protégés tel que défini dans le tableau 8.1 listant les résistances chimiques. Si une substance est renversée, débranchez l'appareil du secteur et suivez les instructions détaillées dans le paragraphe « Maintenance, entretien et réparation par le client ».
	<b>Ne</b> couvrez pas l'Integrity 10 ou le bloc d'alimentation ( <b>EN PARTICULIER LES FENTES D'AÉRATION</b> ) lorsqu'ils fonctionnent.
	Il <b>n'est pas</b> recommandé de laisser tout appareil de chauffage sans surveillance pendant son fonctionnement.
	N'utilisez que des pièces et des accessoires d'origine provenant du fabricant du matériel. Réf. paragraphe 11.
	Le matériel n'est pas résistant aux étincelles, au feu ou aux explosions et n'a pas été conçu pour être utilisé dans des zones dangereuses au sens de la norme BSEN 60079-14:1997. Maintenez les substances inflammables à point éclair bas éloignées de l'appareil.
	<b>Ne</b> faites fonctionner ni ne manipulez aucune pièce de ce produit avec les mains mouillées.

	<b>Ne</b> touchez pas l'intérieur des cellules lorsque l'appareil est en fonctionnement. <b>Faites attention lorsque vous manipulez de la verrerie CHAUDE ou FROIDE.</b>
	Veillez à ce que l'appareil ait atteint la température ambiante avant d'ôter le couvercle.
	Lorsque le couvercle a été ôté et que l'intérieur de l'appareil est exposé, ne mettez pas vos doigts à l'avant ou à l'arrière de l'appareil car ils risqueraient d'être piégés.
	<b>Ne</b> vous penchez pas ou ne vous allongez pas sur l'appareil lorsqu'il est en fonctionnement.
	Éloignez les fiches secteurs et les câbles de toute surface chauffante.
	<b>Avertissement concernant l'écran tactile.</b> L'écran est résistant à l'acétone. Il est recommandé d'essuyer immédiatement tout produit chimique renversé sur l'écran.
	<b>Attention :</b> La verrerie standard fournie pour l'appareil Integrity n'est pas conçue pour des utilisations à haute pression. La pression de fonctionnement maximale d'une verrerie standard équipée d'un bouchon est de 0,5 bar.
	<b>Attention :</b> Les récipients en verre peuvent exploser ou implorer violemment, soit spontanément par rupture de contrainte causée par la pression ou le vide, ou à cause d'un impact accidentel. Avant chaque utilisation, vérifiez soigneusement les récipients en verre à la recherche de craquelures étoilées, de rayures ou de marques de gravure. Les craquelures peuvent augmenter la probabilité de casse ou permettre aux produits chimiques de s'infiltrer dans l'appareil. Réalisez toutes les opérations sous pression ou sous vide dans des récipients en verre derrière une protection adaptée et utilisez des équipements de protection individuels (protection faciale complète, gants, vêtements de protection) pendant la manipulation.
	<b>Attention :</b> Les récipients en verre qui ont été placés dans un bloc à haute température ne doivent pas être placés dans un bloc froid car cela est susceptible de les briser.
	<b>Des précautions doivent être prises</b> lorsque des solvants inflammables sont utilisés. Les approches qui pourraient être adoptées pour réduire le risque d'incendie incluent l'introduction d'une atmosphère inerte à l'intérieur des tubes de réaction et/ou l'utilisation de l'appareil dans une zone correctement ventilée, comme par exemple sous une hotte aspirante.

<b>Informations complémentaires concernant la sécurité</b>	
Bouchons en PTFE ATS20002 et ATS20003.	Pour les composants individuels, voir ci-dessous.
Viton (joint principal) et joints toriques.	Le Viton est résistant à un grand nombre de produits chimiques tels que l'huile, les milieux aqueux et la plupart des autres fluides.  Il est recommandé à l'utilisateur de vérifier la compatibilité chimique avant toute utilisation.
Bouchon en PTFE	Le PTFE est résistant à un large éventail de produits chimiques y compris l'ozone, le chlore, l'acide acétique, le sulfate d'ammonium et l'acide chlorhydrique. Les seuls produits chimiques connus pouvant avoir un effet sur ces revêtements sont les métaux alcalins fondus et les agents de fluoration très réactifs.  Il est recommandé à l'utilisateur de vérifier la compatibilité chimique avant





	toute utilisation.
Bouchon et cloison en silicone	Caoutchouc de silicone HTV réticulé au peroxyde, classé de type VMQ selon la norme ASTM D 1418. Il est recommandé à l'utilisateur de vérifier la compatibilité chimique avant toute utilisation.
Bouchon du trou de l'échantillon de 2 mm de diamètre en acier inoxydable 316	Il est recommandé à l'utilisateur de vérifier la compatibilité chimique avant toute utilisation.

### 2.3. Sicherheitsinformationen

Dieses Produkt kann unter Einhaltung der Herstelleranweisungen sicher betrieben werden.

















**HINWEIS:** Wird das Gerät nicht gemäß den Bedienungsanweisungen des Herstellers verwendet, kann dies dazu führen, dass Ihr grundlegender Sicherheitsschutz durch das Gerät beeinträchtigt und die Gewährleistung/Garantie ungültig wird. Die Gewährleistung/Garantie deckt keine Schäden durch fehlerhafte Installation oder falsche Verwendung des Geräts ab.









#### Vermeiden von Feuer und Stromschlägen

	Um die Gefahr von Bränden oder Stromschlägen zu verhindern, öffnen Sie das Gehäuse des <b>Integrity-Netzteils NICHT</b> ohne Genehmigung. Nur qualifiziertes Wartungspersonal darf das Netzteil reparieren/warten.
	Stellen Sie sicher, dass die Netzstromversorgung den auf dem Datenschild auf der Unterseite des Netzteils angegebenen Nennleistungen entspricht.
	Betreiben Sie das Gerät <b>niemals</b> ohne Erd-/Masseverbindung. Stellen Sie sicher, dass die Netzspannung in Übereinstimmung mit der entsprechenden aktuellen Gesetzgebung korrekt geerdet ist.
	Stellen Sie das <b>Integrity 10 nicht</b> auf das <b>Netzteil</b>
	Bei Auftreten eines Einzelfehlers, der dazu führt, dass eine Zelle im Netzteil eine Übertemperatur aufweist, besteht ein zusätzlicher Schutz in der Zelle in Form einer <b>thermischen Sicherung</b> .  Die thermische Sicherung sorgt dafür, dass sich die fehlerhafte Zelle nicht über eine Temperatur von etwa 190 °C hinaus aufheizt.  Die thermische Sicherung ist <b>nicht</b> dafür ausgelegt, einzelne Proben vor der weiteren Aufheizung über eine bestimmte Temperatur hinaus zu schützen; falls dieser Schutz erforderlich ist, sind zusätzliche Mittel zu verwenden.

#### Allgemeine sichere Betriebspraxis

	Befolgen Sie bei der Verwendung des Geräts immer die gute Laborpraxis. Beachten Sie die Sicherheitsverfahren Ihres Unternehmens, die gesetzlichen Gesundheits- und Sicherheitsverfahren sowie sämtliche, damit verbundenen Rechtsvorschriften, die für Ihre Arbeitsgebiete gelten. Überprüfen Sie die Laborverfahren für die erhitzten Stoffe und stellen Sie sicher, dass alle potenziellen Gefahren (z.B. Explosionsgefahr, Implosionsgefahr bzw. Gefahr der Freisetzung von toxischen oder entzündlichen Gasen) auf angemessene Weise berücksichtigt wurden, bevor die Arbeit fortgesetzt wird. Beim Erhitzen von bestimmten Stoffen kann es durch die Freisetzung von gefährlichen Gasen eventuell notwendig sein, dass ein Laborabzug oder eine andere Art des Abzugs verwendet wird. <b>(Orientieren Sie sich an den</b>
---	--

	<b>Vorgehensweisen Ihres Unternehmens.)</b>
	Stellen Sie sicher, dass sich das Gerät auf einer sauberen, trockenen, nicht brennbaren und festen Arbeitsfläche mit einem geeigneten Abstand von mindestens 300 mm in jede Richtung von anderen Geräten befindet.
	Überprüfen Sie, dass sich das Netzteil auf einer sauberen, trockenen, nicht brennbaren Fläche befindet und ausreichend Platz für das Stromkabel zum <b>Integrity 10</b> -Gerät und die Netzeingangsleitung bzw. den Steckersatz für den Eingang/Ausgang vorhanden ist und keine unzulässige Biegebeanspruchung herrscht. Achten Sie auf einen geeigneten Abstand für die Luftströmung und Wärmeabgabe.
	Stellen Sie das <b>Integrity 10-Gerät bzw. das Netzteil nicht</b> so hin, dass der Anschluss an bzw. die Trennung vom Stromkabel erschwert wird.
	Stellen Sie das <b>Integrity 10-Gerät bzw. das Netzteil nicht</b> so hin, dass der Anschluss an bzw. die Trennung von der Kühlflüssigkeitszuführung erschwert wird.
	Stellen Sie das <b>Integrity 10-Gerät bzw. das Netzteil nicht</b> so hin, dass der Anschluss bzw. die Trennung von Daten- und Kommunikationskabeln erschwert wird.
	Stellen Sie das Netzteil <b>nicht</b> so hin, dass der An-/Aus-Schalter oder die IEC-Netzsteckdose auf der Rückseite unzugänglich sind.
	Tauchen Sie <b>kein</b> Teil dieses Gerätes in Wasser/eine Flüssigkeit.
	Verschütten Sie <b>keine</b> Stoffe auf dem Touch Screen. Die Gehäusematerialien verfügen über den in Tabelle 8.1 "Darstellung der chemischen Beständigkeit" angegebenen Schutz. Wurden Stoffe verschüttet, trennen Sie die Einheit von der Netzstromversorgung und befolgen die Anweisungen des Abschnitts "Wartung, Instandhaltung und Reparaturen".
	Verdecken Sie das Integrity 10-Gerät bzw. das Netzteil ( <b>INSBESONDERE BELÜFTUNGSSCHLITZE</b> ) während der Nutzung <b>nicht</b> .
	Es wird <b>nicht</b> empfohlen, ein Heizgerät während des Betriebs unbeaufsichtigt zu lassen.
	Verwenden Sie nur Teile und Zubehör von Originalgeräteherstellern. Siehe Abschnitt 11.
	Das Gerät ist nicht funkengeschützt, flammbeständig oder explosionsgeschützt und wurde nicht für die Nutzung in gefährlichen Bereichen gemäß BSEN 60079-14:1997 ausgelegt. Halten Sie entzündliche Stoffe mit niedrigem Flammpunkt vom Gerät fern.
	Bedienen bzw. fassen Sie <b>keine</b> Teile des Produkts mit nassen Händen an.
 	Berühren Sie das Innere der Zellen <b>nicht</b> , wenn sich das Produkt in Betrieb befindet. <b>Vorsicht bei der Handhabung von HEISSEN &amp; KALTEN Glaswaren</b>
 	Achten Sie darauf, dass die Einheit Raumtemperatur erreicht hat, bevor Sie die obere Abdeckung entfernen.

	Stecken Sie, nachdem die obere Abdeckung entfernt wurde und das Innere der Einheit offen ist, Ihre Finger nicht in den vorderen oder hinteren Teil der Einheit, da sie eingeklemmt werden könnten.
	Lehnen bzw. beugen Sie sich während des Betriebs <b>nicht</b> über die Einheit.
	Halten Sie den Netzstecker und das Leitungskabel von der Heizfläche fern.
	<b>Touch Screen-Warnung.</b> Der Bildschirm ist unempfindlich gegen Aceton. Es wird empfohlen, eventuell verschüttete chemische Stoffe sofort vom Bildschirm abzuwischen.
	<b>Warnung:</b> Standardglas, das für das Integrity-Produkt geliefert wird, ist nicht für Hochdruckenwendungen geeignet. Der maximale Betriebsdruck für Standardglas mit installierter Kappe beträgt 0,5 bar.
	<b>Warnung:</b> Glasbehälter können entweder spontan aufgrund von zu starker Belastung durch den Druck oder das Vakuum oder durch unbeabsichtigte Einwirkung heftig explodieren oder implodieren. Prüfen Sie Glasbehälter vor jeder Nutzung sorgfältig auf Risse, Kratzer oder Ätzspuren. Risse können die Wahrscheinlichkeit eines Bruchs erhöhen bzw. dazu führen, dass Chemikalien in das Gerät gelangen. Führen Sie alle Druck- und Vakuumvorgänge in Glasbehältern nur hinter geeigneten Blenden durch und tragen Sie während der Handhabung eine Persönliche Schutzausrüstung (vollständige Gesichtsmaske, Handschuhe, Schutzkleidung).
	<b>Warnung:</b> Glasbehälter, die in einen Block mit einer hohen Temperatur gestellt wurden, dürfen nicht in einen kalten Block gestellt werden, da der Behälter dadurch wahrscheinlich zerspringen wird.
	<b>Vorsicht</b> bei der Verwendung von entzündlichen Lösungsmitteln. Maßnahmen zur Verringerung der Brandgefahr umfassen u.a. die Schaffung einer inerten Atmosphäre in den Reaktionsgefäßen und/oder Verwendung des Geräts in einem gut belüfteten Bereich, z. B. unter einer Abzugshaube.

<b>Weitere sicherheitsinformationen</b>	
ATS20002 und ATS20003 PTFE-Kappen	Was einzelne Komponenten betrifft, siehe unten.
Viton (Hauptdichtung) und O-Ringe.	Viton ist beständig gegen eine Vielzahl von Chemikalien, darunter Öle, wässrige Medien und die meisten anderen Flüssigkeiten.  Es wird empfohlen, dass der Nutzer die chemische Verträglichkeit vor der Verwendung prüft.
PTFE-Kappe	PTFE ist beständig gegen eine Vielzahl von Chemikalien, darunter Ozon, Chlor, Ethansäure, Ammoniak, Schwefelsäure und Chlorwasserstoffsäure. Die einzigen Chemikalien, die diese Beschichtungen nachweislich angreifen, sind geschmolzene Alkalimetalle und hochreaktive Fluorierungsmittel.  Es wird empfohlen, dass der Nutzer die chemische Verträglichkeit vor der Verwendung prüft.
Silikonkappe nseptum	Peroxidisch vernetzter HTV-Silikonkautschuk, klassifiziert gemäß ASTM D 1418 als VMQ. Es wird empfohlen, dass der Nutzer die chemische Verträglichkeit vor der Verwendung prüft.





316 Edelstahl 2 mm Durchmesser Stöpsel Probenahme -Loch	Es wird empfohlen, dass der Nutzer die chemische Verträglichkeit vor der Verwendung prüft.
---	--

## 2.4. Información de seguridad



Este producto ha sido diseñado para funcionar de forma segura si se emplea de acuerdo con las instrucciones del fabricante.

**NOTA:** de no utilizarse este equipo de acuerdo con las instrucciones de manejo del fabricante, la protección básica de seguridad del usuario que ofrece el equipo puede verse comprometida y podría invalidarse la garantía. La garantía no cubre los daños derivados de una instalación incorrecta o del uso indebido del equipo.















### Prevención de incendios y descargas eléctricas



	Para evitar riesgos de incendio o descarga eléctrica, <b>NO</b> abra la caja de la <b>fuente de alimentación (PSU) de Integrity</b> sin autorización. Solo el personal debidamente cualificado debe realizar las tareas de reparación o mantenimiento de la PSU.
	Asegúrese de que la conexión a la red eléctrica cumple las especificaciones indicadas en la placa de identificación situada en la cara inferior de la PSU.
	<b>Nunca</b> utilice este equipo sin conexión a tierra. Asegúrese de que la tensión de la red eléctrica tiene conexión a tierra de acuerdo con la legislación vigente local.
	<b>No</b> coloque la <b>Integrity 10</b> sobre la <b>fuente de alimentación</b> .
	En caso de que se produjera un fallo que causara el sobrecalentamiento de una celda de la unidad, esta dispone de protección adicional en forma de <b>termofusible</b> .  El termofusible está diseñado para proteger celdas defectuosas que se sobrecalientan continuamente por encima de los 190 °C aproximadamente.  El termofusible <b>no</b> está diseñado para proteger muestras individuales que sobrepasan una determinada temperatura; deben emplearse otros medios en caso de que sea necesario ese nivel de protección.

### Práctica operativa y de seguridad estándar

	Siga siempre las buenas prácticas de laboratorio cuando use este equipo. Tenga debidamente en cuenta los procedimientos legislativos de seguridad y de salud y seguridad de su compañía y toda la legislación asociada aplicable en las zonas de operación. Compruebe los procedimientos de laboratorio relacionados con las sustancias susceptibles de calentarse y asegúrese de controlar todos los riesgos (p. ej. riesgo de explosión, implosión o liberación de gases tóxicos o inflamables) que puedan surgir antes de continuar. Cuando caliente determinadas sustancias, la liberación de gases peligrosos puede exigir el uso de una campana de humos u otros medios de extracción. <b>(Consulte las prácticas de su empresa.)</b>
	Asegúrese de que el equipo se utiliza sobre una superficie de trabajo firme, limpia, seca y no combustible y que esté separado al menos 300 mm de otros equipos de su entorno.



	Asegúrese de que la PSU se encuentra en una superficie limpia, seca y no combustible con espacio suficiente para el cable de alimentación que se conecta a <b>Integrity 10</b> y que el cable de alimentación y el enchufe de la red pueden conectarse y desconectarse sin que se doblen. Asegúrese que hay espacio suficiente para que fluya el aire y se disipe el calor.
	<b>No</b> coloque la <b>Integrity 10 o la fuente de alimentación</b> de modo que resulte difícil conectarlas o desconectarlas del conector del cable de alimentación.
	<b>No</b> coloque la <b>Integrity 10 o la fuente de alimentación</b> de modo que resulte difícil conectarlas o desconectarlas del suministro de líquido refrigerante.
	<b>No</b> coloque la <b>Integrity 10 o la fuente de alimentación</b> de modo que resulte difícil conectar o desconectar los cables de datos y comunicación.
	<b>No</b> coloque la PSU de modo que el interruptor de encendido y apagado o la toma de corriente IEC situada en la parte posterior queden inaccesibles.
	<b>No</b> sumerja ninguna pieza de este equipo en agua o líquidos.
	<b>No</b> derrame sustancias sobre la pantalla táctil. Los materiales de la carcasa están protegidos tal y como se indica en la Tabla 8.1 Tabla de resistencia química. Si se produce algún derrame, desconecte el equipo de la red eléctrica y siga las indicaciones de la sección "Mantenimiento, servicio y reparación por parte del cliente".
	<b>No</b> cubra la Integrity 10 ni la PSU ( <b>ESPECIALMENTE LAS RANURAS DE VENTILACIÓN</b> ) mientras están en funcionamiento.
	<b>No</b> es recomendable dejar desatendido ningún aparato calefactor mientras está funcionando.
	Utilice únicamente piezas y accesorios del fabricante del equipo original. Consúltese la sección 11.
	Este equipo no ha sido diseñado a prueba de chispas, llamas o explosión y no ha sido concebido para su uso en zonas peligrosas previstas en la norma BSEN 60079-14:1997. Mantenga alejadas del aparato las sustancias que sean inflamables y tengan un punto de ignición bajo.
	<b>No</b> utilice ni manipule ninguna pieza de este producto con las manos húmedas.
	<b>No</b> toque el interior de las celdas cuando el aparato esté funcionando. <b>Extreme la precaución cuando maneje vidrio CALIENTE y FRÍO</b>
	Asegúrese de que la unidad alcanza la temperatura ambiente antes de retirar la tapa superior.
	Una vez que se retire la tapa superior y quede expuesto el interior de la unidad, no introduzca los dedos en la parte delantera o trasera de dicha unidad ya que podría pillárselos.
	<b>No</b> se apoye o estire sobre la unidad cuando esté funcionando.
	Mantenga el enchufe de red y el cable separados de la superficie de calentamiento.
	<b>Advertencia sobre la pantalla táctil.</b> La pantalla es impermeable a la acetona. Se recomienda limpiar inmediatamente cualquier derrame de sustancias químicas sobre la pantalla.
	<b>Advertencia:</b> el vidrio estándar suministrado para el producto Integrity no está diseñado para aplicaciones a altas presiones. La presión máxima de funcionamiento del vidrio estándar con la tapa puesta es de 0,5 bares.
	<b>Advertencia:</b> los recipientes de vidrio pueden explotar o implosionar de forma violenta, ya sea de manera espontánea por un fallo de tensión debido a la presión o el vacío, ya sea por un golpe accidental. Compruebe bien que los recipientes de vidrio no presentan grietas, arañazos

	o marcas de grabado antes de usarlos. Las grietas pueden aumentar la probabilidad de rotura o de fugas de productos químicos en el equipo. Realice todas las operaciones de presión y vacío en los recipientes de vidrio tras una pantalla de protección adecuada y utilice equipos de protección personal (máscara completa, guantes y prendas de protección) durante su manipulación.
	<b>Advertencia:</b> los recipientes de vidrio que se hayan colocado en un bloque a altas temperaturas no deben introducirse en un bloque frío, ya que es probable que se hagan añicos.
	<b>Deben extremarse las precauciones</b> cuando se utilicen disolventes inflamables. Algunos métodos que pueden emplearse para reducir el riesgo de incendio consistirían en introducir una atmósfera inerte en los tubos de reacción o emplear los equipos en zonas bien ventiladas, p. ej. bajo una campana de humos.

<b>Información complementaria acerca de la seguridad</b>	
Tapones de politetrafluoroetileno (PTFE) ATS20002 y ATS20003.	Para componentes individuales, véase más abajo.
Juntas de Viton (junta principal) y tórica.	El Viton es resistente a una gran variedad de agentes químicos como los aceites, los medios acuosos y la mayoría del resto de líquidos.  Se recomienda al usuario que compruebe la compatibilidad química antes de su utilización.
Tapón de PTFE.	El PTFE es resistente a una gran variedad de agentes químicos como el ozono, cloro, ácido acético, ácido sulfúrico de amoníaco y ácido hidroclicóric. Los únicos productos químicos que se sabe que afectan a estos revestimientos son los metales alcalinos fundidos y los agentes fluorantes altamente reactivos.  Se recomienda al usuario que compruebe la compatibilidad química antes de su utilización.
Diafragma del tapón de silicona.	Caucho silicónico HTV reticulado por peróxido, clasificado de acuerdo con ASTM D 1418 como VMQ. Se recomienda al usuario que compruebe la compatibilidad química antes su utilización.
Tapón para agujeros de muestreo de acero inoxidable 316 de 2 mm de diámetro.	Se recomienda al usuario que compruebe la compatibilidad química antes su utilización.





## 2.5. Informazioni sulla sicurezza

Il presente prodotto è stato progettato per un funzionamento sicuro quando utilizzato secondo le istruzioni del fabbricante.







**NOTA:** Il mancato rispetto delle istruzioni operative fornite dal fabbricante può compromettere la sicurezza di base offerta dall'apparecchiatura e rendere nulla la garanzia. La garanzia non copre i danni causati da un'installazione scorretta o da un uso improprio dell'apparecchiatura.





















## Prevenzione degli incendi e delle scosse elettriche

	Per evitare il rischio di incendio o scossa elettrica, <b>NON</b> aprire l'alloggiamento dell' <b>unità di alimentazione (PSU) di Integrity</b> senza autorizzazione. Solo il personale qualificato addetto alla manutenzione può tentare di riparare/manutenere l'unità di alimentazione (PSU).
	Assicurarsi che l'alimentazione della rete elettrica sia conforme ai dati nominali indicati nella targhetta identificativa posizionata sul lato inferiore dell'unità di alimentazione (PSU).
	Non utilizzare <b>mai</b> questa apparecchiatura senza il collegamento di terra/massa. Assicurarsi che la tensione di alimentazione sia correttamente messa a terra/massa in conformità con la legislazione vigente nel proprio paese.
	<b>Non</b> posizionare <b>Integrity 10</b> sopra l' <b>unità di alimentazione (PSU)</b>
	<p>Se si verifica una condizione di primo guasto che fa sì che una cella all'interno dell'unità sia in sovratemperatura, nella cella è presente un <b>fusibile termico</b> che funge da ulteriore protezione.</p> <p>Il fusibile termico è progettato per proteggere una cella in guasto che riscalda continuamente a una temperatura che supera approssimativamente i 190 °C.</p> <p>Il fusibile termico <b>non</b> è progettato per proteggere i singoli campioni che vengono riscaldati oltre una determinata temperatura; se si necessita di un tale livello di protezione occorre adottare altre misure.</p>

## Pratica di utilizzo sicuro generale

	Seguire sempre le buone pratiche di laboratorio quando si utilizza questa apparecchiatura. Prendere conoscenza e implementare le procedure per la salute e la sicurezza vigenti, quelle stabilite dalla propria azienda e da qualsiasi normativa applicabile alla propria area di lavoro. Controllare le procedure di laboratorio per le sostanze che vengono riscaldate e assicurarsi che tutti i rischi potenziali (ad es. rischio di esplosione, implosione o rilascio di gas tossici o infiammabili) siano stati adeguatamente presi in considerazione prima di procedere. Quando si riscaldano determinate sostanze, il rilascio di gas pericolosi può rendere necessario l'utilizzo di una cappa aspirante da laboratorio o di altri mezzi di estrazione. <b>(Consultare le pratiche stabilite dalla propria azienda).</b>
	Assicurarsi che l'apparecchiatura venga utilizzata su una superficie di lavoro pulita, asciutta, non combustibile e solida con una distanza idonea su ogni lato di almeno 300 mm da altre apparecchiature.
	Assicurarsi che l'unità di alimentazione (PSU) sia posizionata su una superficie pulita, asciutta e non combustibile con uno spazio sufficiente per il cavo di alimentazione di <b>Integrity 10</b> e che il cavo di alimentazione di rete e la spina possano essere collegati/scollegati senza flessioni ingiustificate. Assicurarsi che via sia uno spazio idoneo per il flusso dell'aria e la dissipazione del calore.
	<b>Non</b> posizionare <b>Integrity 10 o l'unità di alimentazione</b> in modo tale da rendere difficile il collegamento o lo scollegamento dei cavi di alimentazione.
	<b>Non</b> posizionare <b>Integrity 10 o l'unità di alimentazione</b> in modo tale da rendere difficile il collegamento o lo scollegamento dell'alimentazione del fluido refrigerante.
	<b>Non</b> posizionare <b>Integrity 10 o l'unità di alimentazione</b> in modo tale da rendere difficile il collegamento o lo scollegamento dei cavi di comunicazione/dati.
	<b>Non</b> posizionare l'unità di alimentazione (PSU) in modo tale da rendere inaccessibili l'interruttore di on/off o la presa di alimentazione IEC collocata sul retro.
	<b>Non</b> immergere alcuna parte di questa apparecchiatura in acqua/fluidi.

	<b>Non</b> lasciar cadere alcuna sostanza sul touchscreen. I materiali dell'alloggiamento sono protetti come stabilito nella Tabella 8.1 Resistenza chimica. Se si verifica un versamento, scollegare l'unità dall'alimentazione di rete e seguire le istruzioni indicate nella sezione "Manutenzione, assistenza e riparazioni del cliente".
	<b>Non</b> coprire Integrity 10 o l'unità di alimentazione (PSU) <b>(IN PARTICOLARE I CONDOTTI DI AERAZIONE)</b> durante l'uso.
	Si <b>sconsiglia</b> di lasciare incustodito qualsiasi apparecchio riscaldante durante il funzionamento.
	Utilizzare esclusivamente accessori e parti OEM. Fare riferimento alla sezione 11.
	L'apparecchiatura non è a prova di scintilla, fiamma o esplosione e non è stata progettata per l'uso in aree pericolose secondo la norma BSEN 60079-14:1997. Tenere lontano dall'apparecchiatura le sostanze infiammabili e a basso punto di infiammabilità.
	<b>Non</b> utilizzare o manipolare nessuna parte di questa apparecchiatura con le mani bagnate.
 	<b>Non</b> toccare la parte interna delle celle mentre il prodotto è in funzione. <b>Prestare attenzione quando si manipolano oggetti di vetro FREDDI O CALDI</b>
 	Assicurarsi che l'unità abbia raggiunto la temperatura ambiente prima di rimuovere la copertura superiore.
	Quando la copertura superiore è stata rimossa e l'interno dell'unità è esposto, non inserire le dita nella parte anteriore o posteriore dell'unità per evitare che rimangano incastrate.
	<b>Non</b> appoggiarsi o allungarsi sull'unità durante il funzionamento.
	Tenere il cavo di alimentazione e la presa lontano dalla superficie riscaldante.
	<b>Touchscreen, avvertenza.</b> Lo schermo è resistente all'acetone. Si consiglia di rimuovere immediatamente dallo schermo qualsiasi versamento di sostanze chimiche.
	<b>Avvertenza:</b> Gli strumenti standard in vetro forniti per il prodotto Integrity non sono progettati per applicazioni ad alta pressione. La pressione massima di esercizio degli strumenti standard in vetro con cappuccio inserito è di 0,5 bar.
	<b>Avvertenza:</b> I recipienti in vetro possono esplodere o implodere violentemente, in modo spontaneo per le sollecitazioni dovute alla pressione o al vuoto, oppure a causa di un impatto accidentale. Verificare attentamente che i recipienti in vetro non presentino crepe a raggiera, graffi o segni di corrosione prima dell'uso. La presenza di crepe può aumentare la probabilità di rottura o consentire alle sostanze chimiche di penetrare nell'apparecchiatura. Eseguire tutte le operazioni in pressione o vuoto nei recipienti di vetro dietro adeguata protezione e utilizzare dispositivi per la protezione individuale (protezione completa del viso, guanti, abbigliamento protettivo) durante l'uso.
	<b>Avvertenza:</b> I recipienti di vetro che sono stati posizionati in un blocco ad alta temperatura non devono essere collocati in uno a bassa temperatura in quanto potrebbero frantumarsi.
	<b>Prestare attenzione</b> quando si utilizzano solventi infiammabili. Le misure che possono essere adottate per ridurre il rischio di incendio comprendono l'introduzione di un'atmosfera inerte all'interno delle provette di reazione e/o l'utilizzo dell'apparecchiatura in un'area adeguatamente ventilata, ad esempio sotto una cappa aspirante.

<b>Informazioni aggiuntive sulla sicurezza</b>	
Cappucci in PTFE ATS20002 e ATS20003	Per i singoli componenti vedere qui di seguito.
Anello di tenuta Viton (tenuta principale) e O-ring.	L'anello di tenuta Viton è resistente a un'ampia gamma di sostanze chimiche tra cui oli, mezzi acquosi e numerosi altri fluidi.  Si consiglia all'utente di verificare la compatibilità chimica prima dell'uso.
Cappuccio in PTFE	Il PTFE è resistente a un'ampia gamma di sostanze chimiche tra cui ozono, cloro, acido acetico, ammoniaca, acido solforico e acido cloridrico. Le uniche sostanze chimiche note per attaccare questi rivestimenti sono i metalli alcalini fusi e gli agenti di fluorurazione altamente reattivi.  Si consiglia all'utente di verificare la compatibilità chimica prima dell'uso.
Setto del cappuccio in silicone	Gomma siliconica HTV reticolata con perossido, classificata in conformità con ASTM D 1418 come VMQ. Si consiglia all'utente di verificare la compatibilità chimica prima dell'uso.
Tappo per foro di campionamento, diametro 2 mm, in acciaio inossidabile 316	Si consiglia all'utente di verificare la compatibilità chimica prima dell'uso.

### 3. Introduction

The Integrity 10 Reaction Station's evolutionary design allows the user to perform multiple reactions independently and simultaneously. Each cell position can be heated/cooled and stirred independently of the cell, next to, or adjacent to it.

The product can be used inside a fume cupboard, mounted onto a robotic platform or simply operated free standing on a laboratory work surface. For user safety, the Integrity 10 is driven by a low voltage power supplied by the PSU (Power Supply Unit). An Ethernet socket provides a means for connecting and controlling the Integrity 10 as part of an integrated system. RS485 / 232 and a *Gilson Serial Input/Output Channel (GSIOC)* protocol add to the versatility of the product.

The 'Integrity' control software (ATS11005), is available as an accessory and provides the user with a user friendly, intuitive interface.

When used together with the 'Integrity' software, additional accessories can be added to customise the Integrity 10 specifically for given tasks, these include infrared probes for measurement of particles present in any given solution. Solution sample temperatures in each cell position can be accurately measured using the Electrothermal 'Multitemp' probe set. The system can also be used with a Reflux unit designed to prevent fluid sample solution loss from open, exposed glass vessels / test tubes (See section 13 on accessories).

In standalone use the Integrity 10 is easy to set up using the touch screen. With an intuitive menu system, operation is both quick and simple allowing the user to set up and operate a simple profile or operate with full manual control. Experimental data can be stored and extracted via a USB flash key. The operating system is Microsoft® Windows CE. Firmware is stored on the SD card supplied which can be easily updated.

### 3.1. Instrument specification

#### Unit

Number of Positions	10
Cell Cavity diameter	25mm
Glass vessel fill level	10 - 50mm
Temperature range	-30°C to 150°C
Max ~Temperature difference between any two positions.	Nominal 180°C See note below
Temperature Overshoot	<2°C when measuring in contents.
Maximum controlled heating rate	5°C / min
Maximum controlled cooling rate	5°C / min

**Note:** - See Appendix 'A' Integrity cooling guide for the cooling specification.

Stir speed range	350 - 1200 RPM
Viscosity capacity	Glycerine at 25°C
Recommended stir bar	AZS4235 10 Pack 12 x 4.5mm (cylindrical) AZS4206 10 Pack 10 x 6mm (Oval)

**Note** - Stir performance only guaranteed when using recommended stir bar

#### Recommended specification of cooling system

Working temperature range	5 to -5°C
Cooling capacity	1.1kW (1100W) between 5°C to -5°C
Flow rate	≥ 5 Litres per minute
Pressure	≥ 2 Bar
Inline filter	50 micron

#### Internal Unit Measurement

Measured temperature range	-30°C to +160°C
Temperature resolution	0.01°C
Temperature accuracy	±0.5°C
Measured stir speed range	350 to 1200 RPM
Stir Speed Resolution	10 RPM
Stir Speed Accuracy	±10 RPM

#### Control Ports

RS232/485 Via 10 Pin  
GSIOC Via 8 Pin  
USB Master.  
USB Slave.  
Aux 485 Bus extension

## 4. Unpacking and contents

Please check the contents of your carton against the diagram.

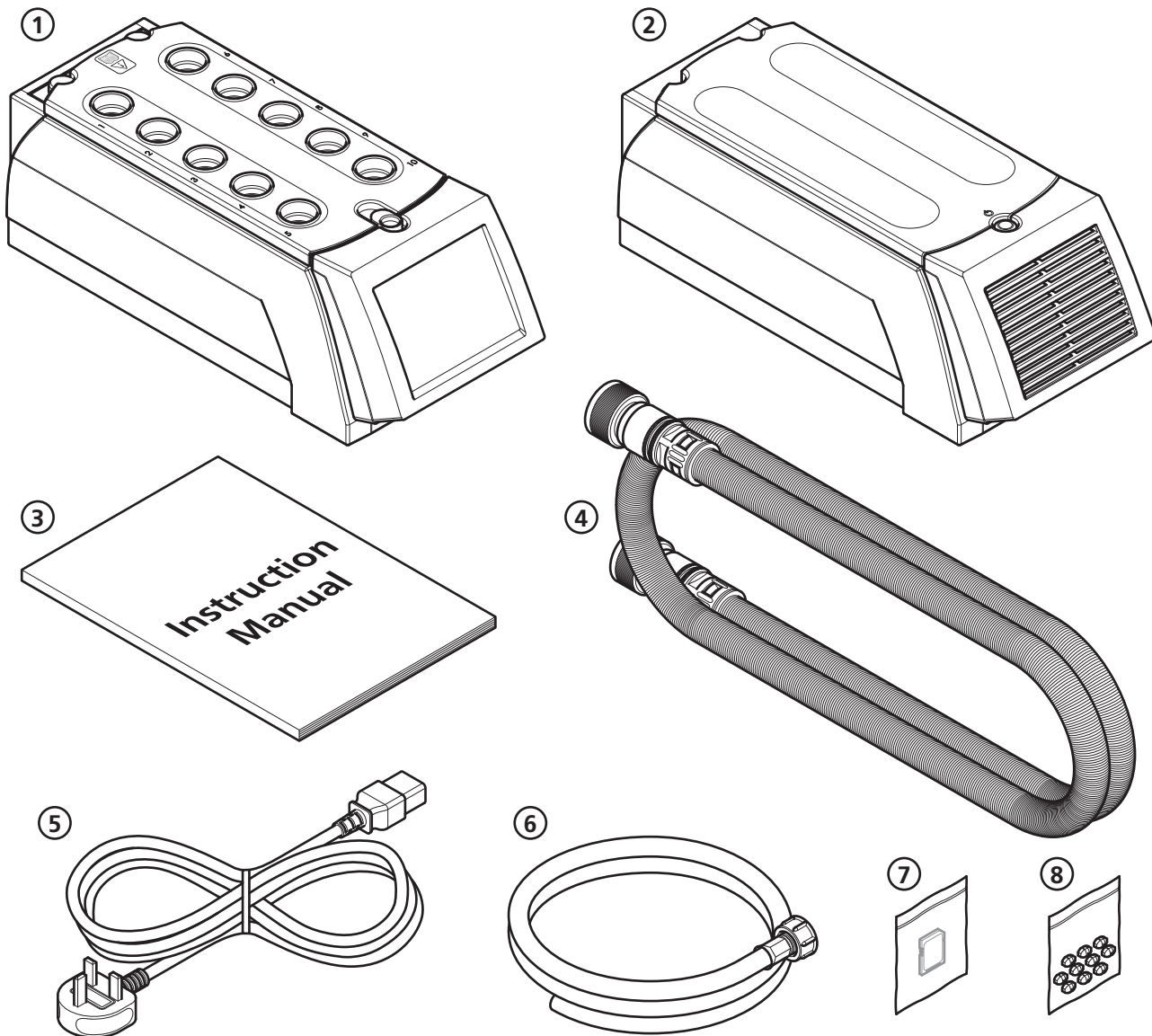

- |   |   |    |
|---|---|----|
| ① | Integrity 10 - Unit                           | x1 |
| ② | Integrity 10 - PSU                            | x1 |
| ③ | Instruction manual                            | x1 |
| ④ | Power cable assembly (illustration only)      | x1 |
| ⑤ | Mains lead UK, EU and US (illustration only)  | x3 |
| ⑥ | Coolant supply hose                           | x2 |
| ⑦ | Programmed SD card (pre-inserted in the unit) | x1 |
| ⑧ | Stir bars (x10)                               | x2 |

For your future reference please record your product's serial and model number	Unit serial number	Unit model / cat number
--	--------------------	-------------------------

## 5. Installation

### Electrical safety and installation

This equipment is designed to be used safely under the following conditions:-

- Indoor use only
- Use in a well ventilated area
- Altitude up to 2000 meters
- Ambient temperature range +5°C to +35°C
- Altitude to 2000m
- Relative humidity not exceeding 80% for temperatures up to 25°C decreasing linearly to 50% relative humidity at 35°C
- Mains supply voltage fluctuations up to  $\pm 10\%$  of the nominal voltage
- Over-voltage category II IEC60364-4-443 applicable
- Pollution degree 2
- Use with a minimum distance all round of 300mm from walls or other items

The Power Supply Unit (PSU) for the Integrity 10 has been subjected to electrical safety testing as part of the manufacturing process. However, it is acknowledged that some end users may wish to undertake further electrical safety testing as part of the installation process.



**AC** dielectric withstand (Flash/Hi Pot) must not be undertaken on this equipment as damage may result. Such testing will invalidate warranty.

**DC** dielectric withstand (flash/Hi Pot) may be applied to the **PSU only** (i.e. The Integrity 10 unit **must not** be connected when the PSU is being tested. The Integrity 10 unit operates at low voltage (15V DC) and must not be subjected to dielectric withstand (Flash/Hi Pot) testing.

DC dielectric withstand (flash/Hi Pot) testing shall only be undertaken by competent trained personnel using suitable test equipment / environment.

DC test voltage should be no more than 1.414 times normal AC test value for a class I (grounded) equipment.

The test equipment/process should incorporate a discharge procedure to remove any stored DC charge that may remain on the PSU.



This equipment must be earthed/grounded to a fixed earth/grounded mains socket outlet. The mains supply is to be earthed/grounded in accordance with current international and local legislation as applicable in the country/state of operation.

Ensure only the correct rated mains input fuses are fitted. (Where applicable ensure the correct Mains cord and moulded IEC plug and lead set fuse if fitted). See Technical Specification, Section 10 of this Instruction manual.

Check the voltage on the product data label on this product unit and those of any accompanying electrical accessory. Ensure the rating conforms to your local supply.

It is recommended this product should be connected to a mains supply source which incorporates an RCD or GFCI device that has a tripping current of 30mA or less. The RCD or GFCI residual Current Device cuts off power to the equipment immediately it detects a current leakage fault.



Do not install this product or accessories on a surface which may become wet from use with other equipment.

The unit is supplied with a Mains cord and moulded plug wired as follows.

Green/Yellow	or	Green	=	Earth/Ground
Blue	or	White	=	Neutral
Brown	or	Black	=	Live/line hot.

Connect the power cable between the Integrity 10 PSU and the Integrity 10 unit. Push the plug into the socket ensuring the lugs engage **1** then twist the lock ring clockwise to secure **2**. Repeat the process for attaching the other end of the power cable to the PSU.

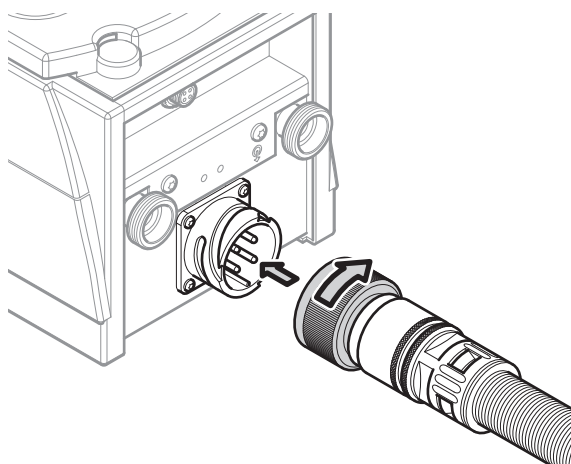

Connect the coolant supply to the Integrity 10 unit ensuring the supply outlet feeds the indicated reaction block inlet and the return is connected to the indicated outlet. Turn on the coolant supply and check there are no signs of any water leaks around the connectors. (Turn off the chilled water supply after checking for leaks).

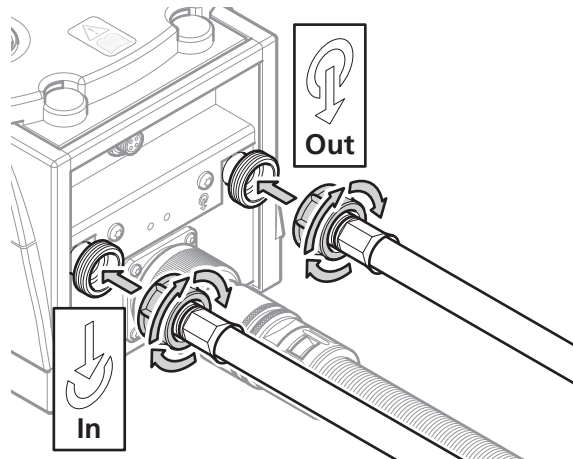

*To ensure efficient heating and cooling, the Integrity cell design incorporates high quality copper heat sink components that ensure optimum heat transfer between the process and the cooling media.*

*When good quality coolant water is used, no service problems will be experienced associated with internal corrosion or blockages. However, if coolant water is deficient (e.g. hard water, high oxygen content, turbid, contaminated, debris, etc.) and this results in the internal corrosion, or blockage of the cooling system, then this is beyond the control of the equipment manufacturer. As such Cole-Parmer Limited cannot support warranty claims for blockages, corroded cells etc. that are attributable to poor quality coolant water.*

*To guard against poor water quality and its affects, the following recommendations are made.*

- 1. At installation, the end user should ensure that the cooling water supply is of distilled water quality.*
- 2. Additives are not recommended*
- 3. A coolant inline filter is recommended to filter to 75 micron. This should be checked / cleaned at intervals to suit local operating conditions.*
- 4. Minimal annual service check by Cole-Parmer Limited, or its designated service agent, is recommend which includes flushing/back flushing/removal and inspection of cell conditions for any early signs of coolant water problems.*



**Note:** - See Appendix 'A' Integrity cooling guide for the cooling specification.

For temperatures below 5°C, or as recommended in the chiller manual, a coolant must be used. A mix of 1:1 laboratory grade ethylene glycol and water is recommended. DO NOT use deionised water.

**WARNING:**



- Do not use flammable coolants.
- Consult the chiller manual to ensure a compatible fluid is used.
- The fluid must be compatible with the incubator's wetted parts which are copper, stainless 303, aluminium and nitrile.
- Ensure all tubing is kept free of kinks and restrictions and is held tidily in place using tie wraps if necessary.

**Operating pressure up to 2.0bar - Maximum safe pressure 4.5bar.**

**(For PC connection only)** Connect a USB data cable to the Integrity 10 unit as illustrated below. You can then connect the other end of the USB data cable to the host PC in the USB port of your choice.

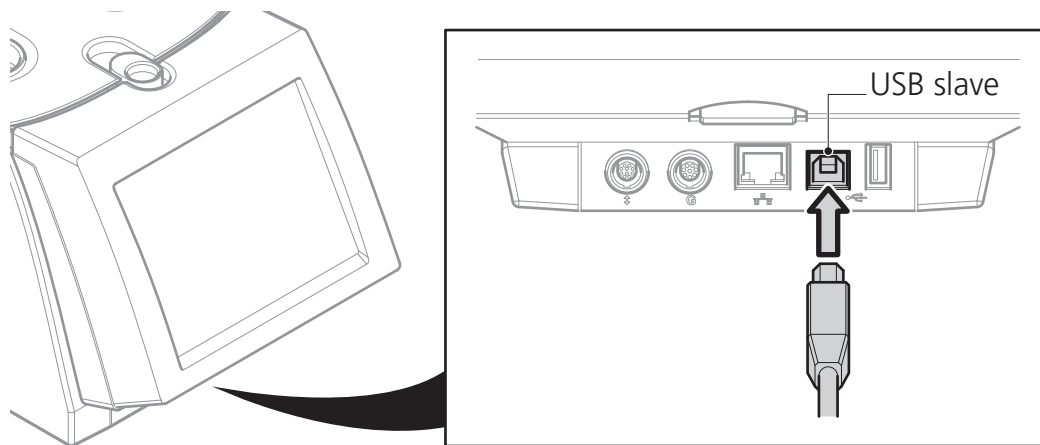

Connect the PSU to the mains supply using the plug and lead set supplied with the Integrity. Turn on the mains power supplying the PSU.

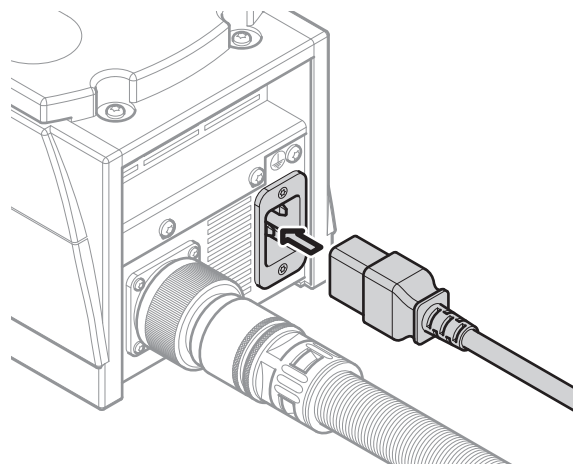

## 6. Environmental protection

Electrothermal has given due consideration to environmental issues within the design and manufacturing process of this product without compromising product performance and value.



Packaging materials have been carefully selected so they can be sorted for recycling.



At the end of your product and accessories life, it must not be discarded as domestic waste. Ref: EU Directive 2012/19/EU on Waste Electrical and Electronic Equipment Directive (WEEE). \*Please contact your distributor / supplier for further information. For end users outside of the EU consult applicable regulations.

This product should only be dismantled for recycling by an authorised recycling company.



***This product and accessories must be accompanied by a completed Decontamination Certificate prior to any disposal. Copies of the Certificate are available from Distributor/Manufacturer.***

### 6.1. Battery disposal

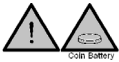

***This product contains a Lithium Cell button Battery (CR2032) on the control PCB located in the front Pod of the Integrity 10 Unit. All batteries must be disposed of in accordance with regulations. DO NOT dispose of product in a fire as batteries may explode.***

*Cole-Parmer's Electrothermal branded product range is registered with the Environment Agency under the name of as Electrothermal Engineering Limited as being a producer of WEEE (Waste Electronic and Electrical Equipment) through b2b Compliance, an authorised waste collection compliance scheme.*

## 7. Product operation

### 7.1. Product overview

Integrity 10 unit

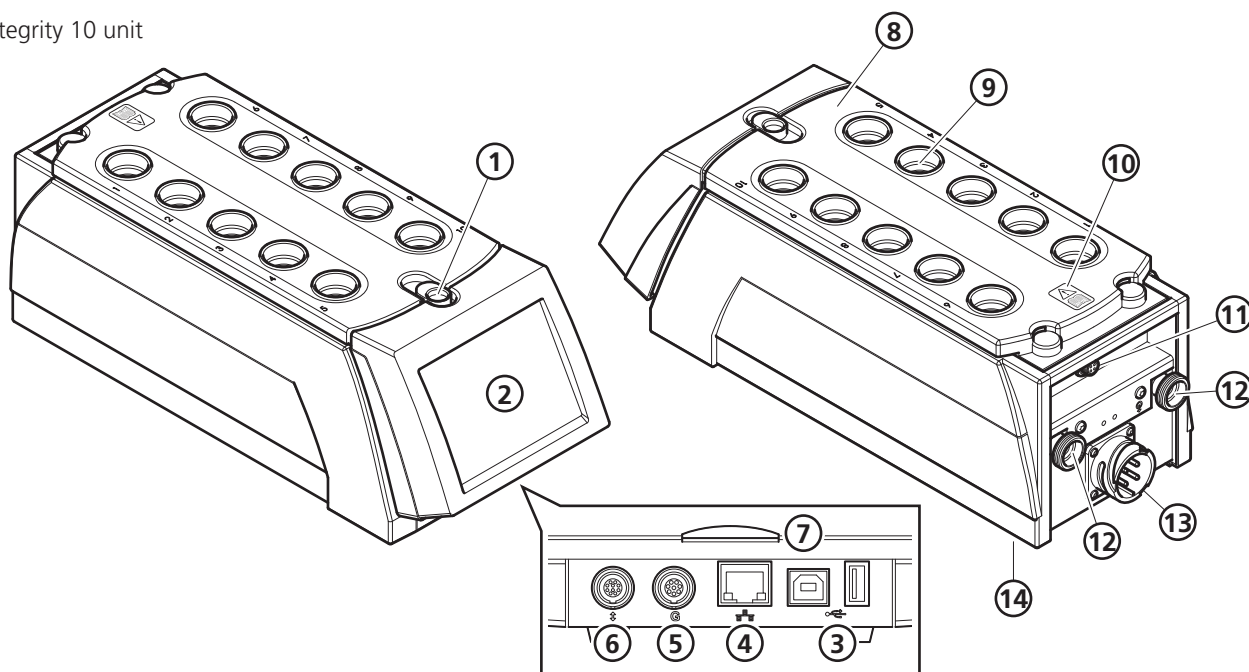

- |   |                              |   |   |
|---|------------------------------|---|---|
| ① | Latch (drip tray release)    | ⑧ | Drip tray   |
| ② | Touch sensitive screen       | ⑨ | Reaction well   |
| ③ | USB ports (master and slave) | ⑩ | Refer to Instruction book warning                             |
| ④ | Ethernet RJ45 socket         | ⑪ | Bus socket (for driving accessories)                          |
| ⑤ | GSIOC protocol socket        | ⑫ | In / out coolant water supply                                 |
| ⑥ | RS232 / 485 protocol socket  | ⑬ | Plug for power cable  |
| ⑦ | SD card slot                 | ⑭ | Data plate label<br>(found on underside of the reaction unit) |

Power supply

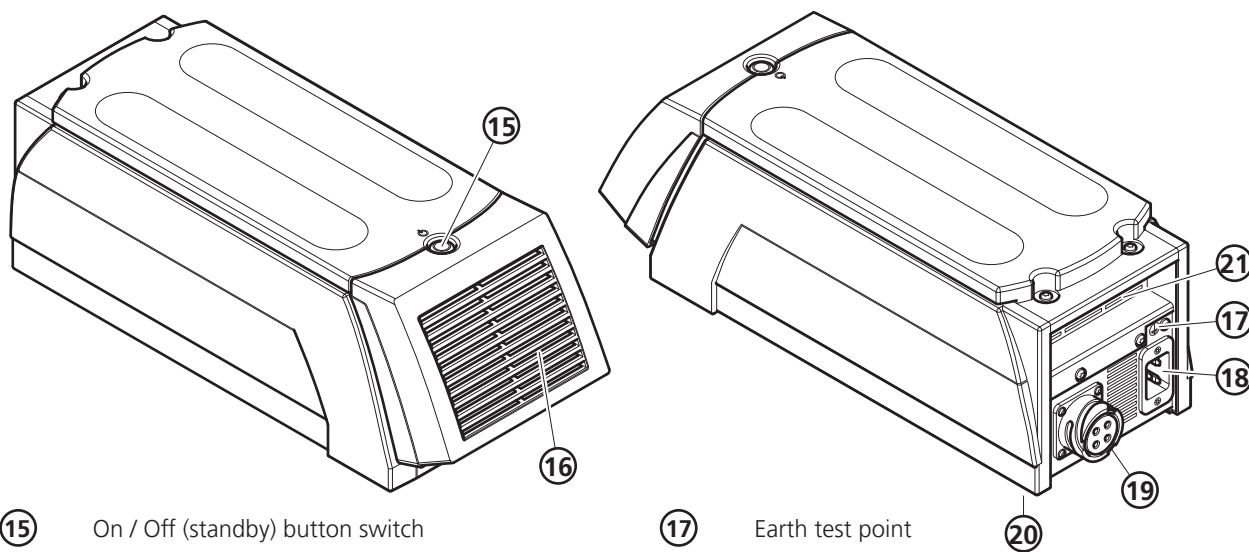

- |   |                                  |   |  |
|---|----------------------------------|---|--|
| ⑮ | On / Off (standby) button switch | ⑰ | Earth test point   |
| ⑯ | Front grill – cooling vents      | ⑱ | Socket for power cable                                   |
|   |                                  | ⑲ | Socket for power cable                                   |
|   |                                  | ⑳ | Data plate label<br>(found on underside of the PSU unit) |
|   |                                  | ㉑ | Cooling vents  |

## 7.2. Reduction sleeves - fitting and removal



Always ensure the cell temperatures are at a safe temperature to touch. (Between 40°C and -5°C)  
Always turn off the coolant water supply before removing the drip tray.

### Insert reduction sleeve

Insert reduction sleeves by pushing them straight into the cells. Reduction sleeves may be fitted into any cell position.

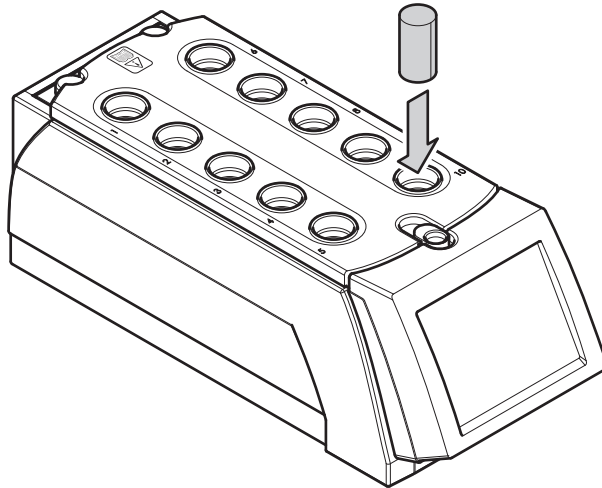

### Remove reduction sleeve

To remove the reduction sleeves, release the latch on the top of the Integrity unit **i** and lift off the drip tray **ii** and **iii**.

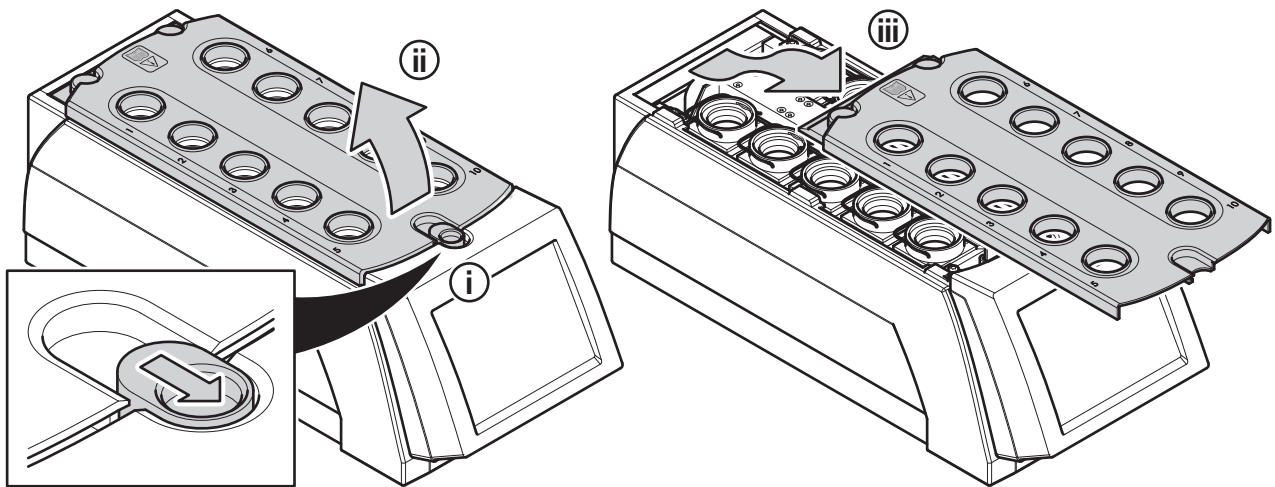

Push in the oil seal retention clip **iv** and lift out oil seal **v**.

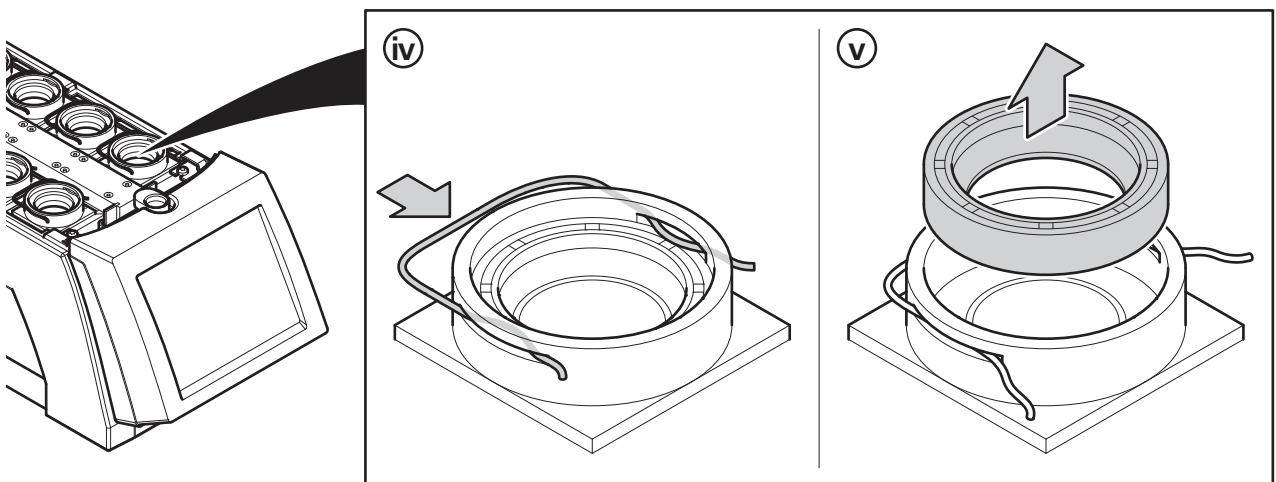

Lift reduction sleeves out of cells **vi**.

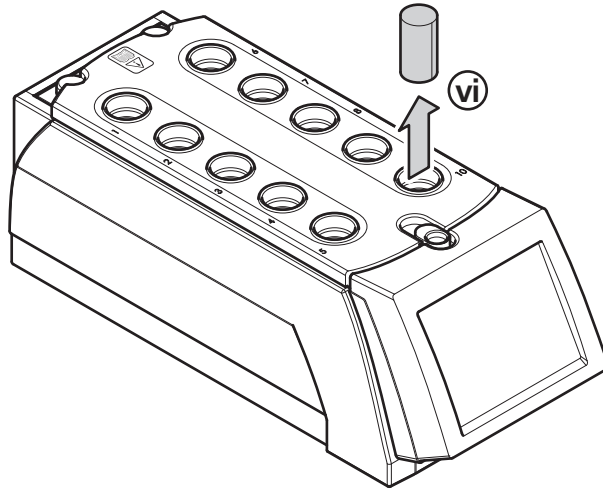

Replace the oil seal **vii** and reposition the retention clip **viii**.

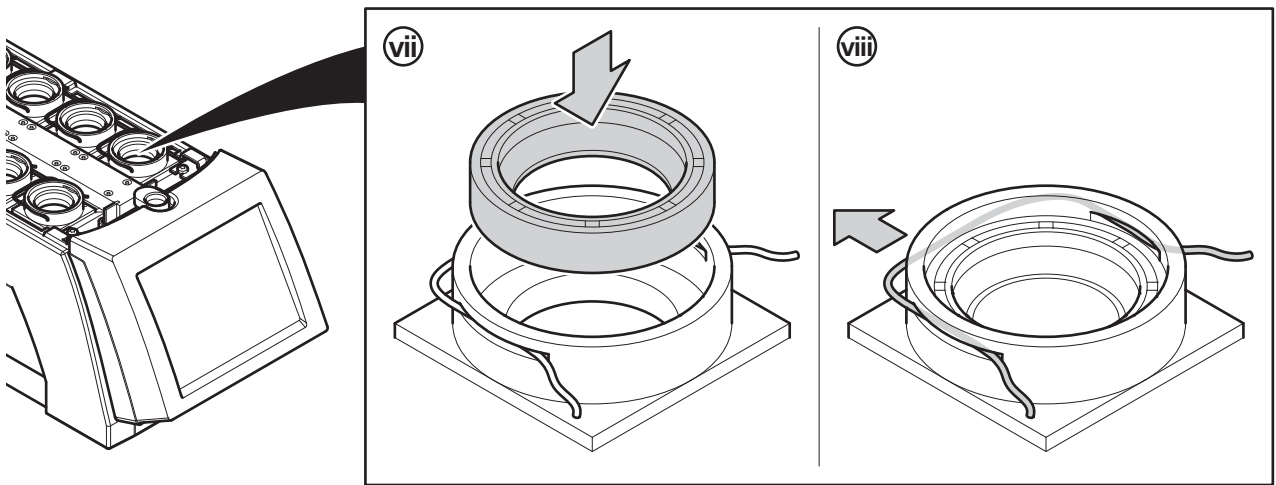

Replace the drip tray **ix** and **x** ensuring the latch is engaged properly **xi**.

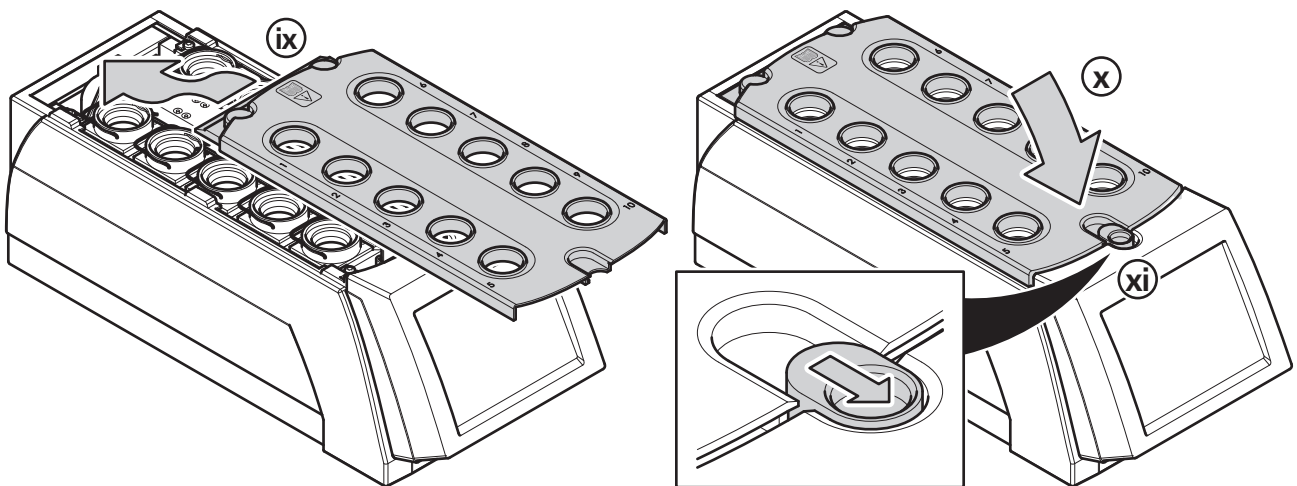

### 7.3. Insert SD card

**Note:** Your Integrity 10 unit will have been despatched with the card already in position. Your Integrity unit will not function without it fitted.

Insert the SD card supplied into the SD card slot, with the card contacts facing the back. **Leave the SD card in place during use. The SD card is acting as the system hard drive.**

**Note:** Your SD card has been programmed for use specifically with the Integrity system for which it was supplied. If the card is swapped with another SD card programmed for use with another integrity system the touch screen buttons may not align with the screen touch sensing points. Observe the correct orientation of the SD card.

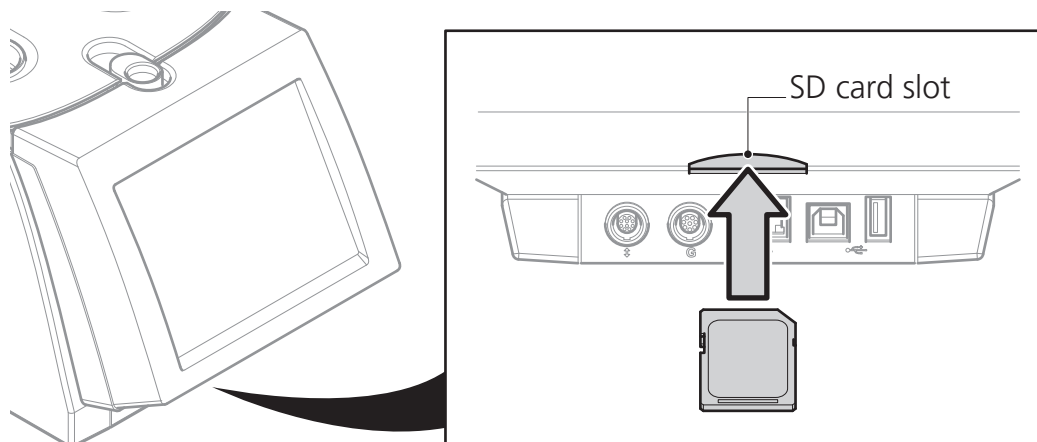

**DO NOT remove the SD card when the unit is powered up or operating. Loss of data and program corruption may occur.**

### 7.4. Turn unit ON

**Note:** Ice will form around the Integrity 10 cell assemblies when the unit is run for extended periods at temperatures below 0°C.

Ensure chilled water supply and mains power are connected and turned on. See Appendix 'A' Integrity cooling guide for the cooling specification. Make sure to turn the water on before turning on the power. If this is not done an error message may appear.

Press the button on top of the Power Supply Unit to commence operation. Observe the green luminance of the power on switch.

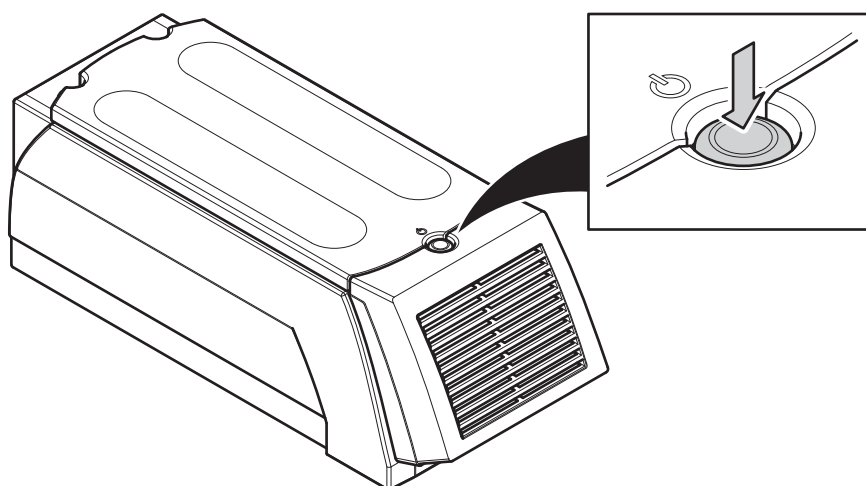

The Integrity 10 can be used in conjunction with STEM Integrity control software (ATS11005), or it can be run in standalone mode. In standalone mode the Integrity 10 can be set up and run via manual control or via a profile set-up.

### 7.5. Turn unit OFF

Depress the Power Supply button once again to turn off the unit.

## 7.6. Power up

When the Integrity 10 is first powered up it will go through a self check and warm up cycle which will take a few minutes. During this time period a splash screen will be displayed.



*Typical splash screen for the Integrity 10 Unit.*

After the Splash screen has been displayed the home screen will come into view.

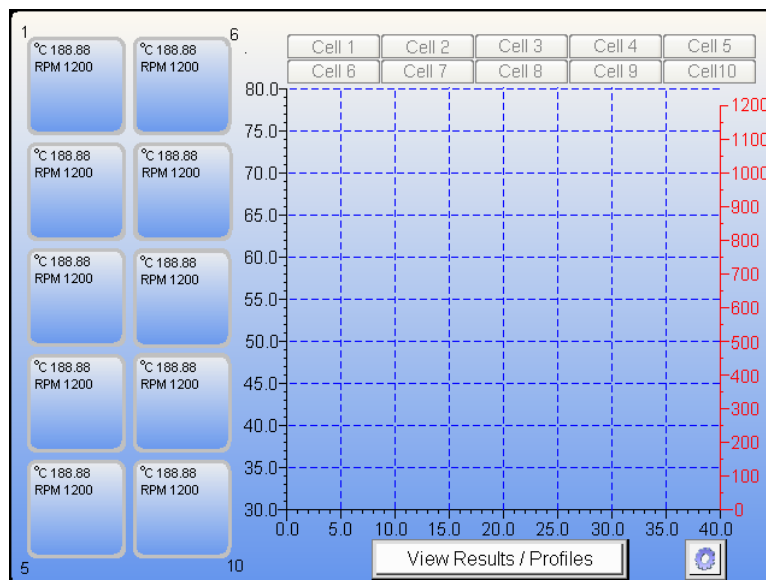

*Home screen for the Integrity 10*

## 7.7. Time and date setting

The first time the Integrity 10 system is used the time clock and date must be set. The time and date setting is performed using the following method.

**Note:** Accurate clock time is required when using data storage facility as the experiment data stored is time stamped.

Touch the settings Icon to enter settings mode.

**Note:** Settings mode cannot be accessed if any cell positions are in use.



Touch the clock Icon to enter the clock and date settings mode.

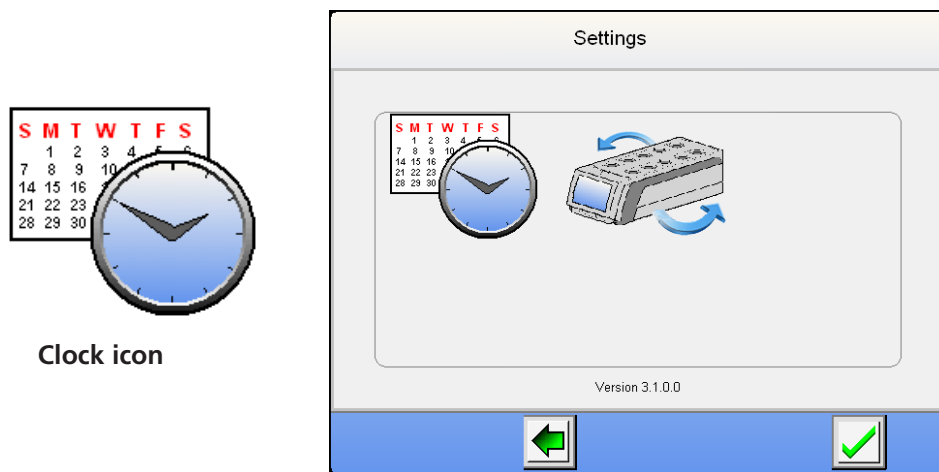

From the clock setting screen use the up/down arrowed buttons to set the correct time and date.

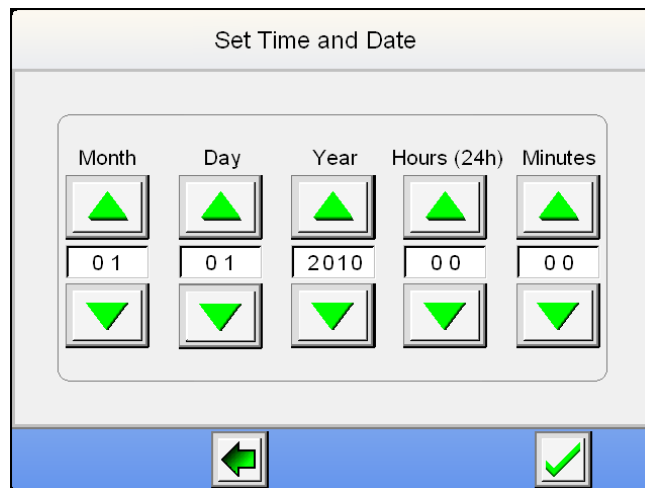

Once the correct date and time has been entered press the Green tick button to accept the setting entered. You are now taken back to the home screen from which you commence operation.



## ALTERNATIVE METHOD

Touch the display field you wish to set.

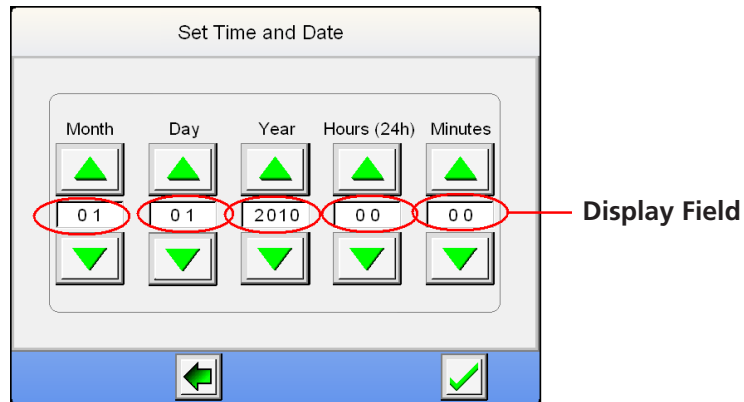

Select the setting required from the touch pad screen. Touch the green tick to except the setting or touch the red cross to clear the field and re-enter the field setting. The green back arrow will take you back to the previous screen.

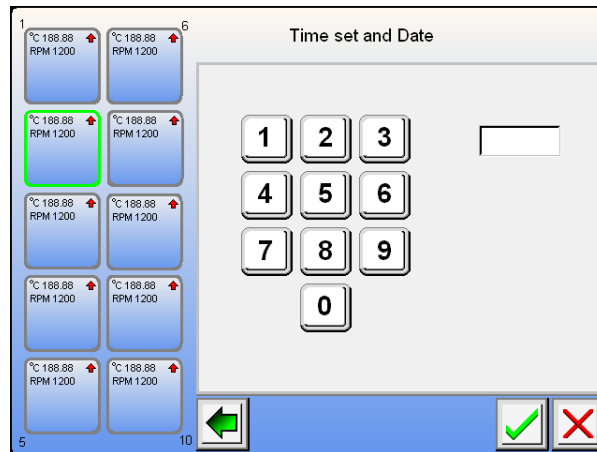

**Note:** Daylight saving time settings will need to be adjusted using the time setting process as described above.  
**Note:** The date will automatically adjust for leap years.

### 7.8. Communication protocol selection (for use with external control)

To change the protocol to accept GSIOC ensure your host systems communication platforms protocol is GSIOC driven.

Touch the settings Icon to enter settings mode.



**Note:** Settings mode can only be entered immediately after the Integrity has been switched on. Once run settings have been made the settings icon will disappear.

To enter 'settings mode' at any time ensure all cells are turned off.

Touch the communication Icon in the settings screen to enter communication selection.

**Note:** GSIOC mode must be selected to control via ATS11005 Integrity software.

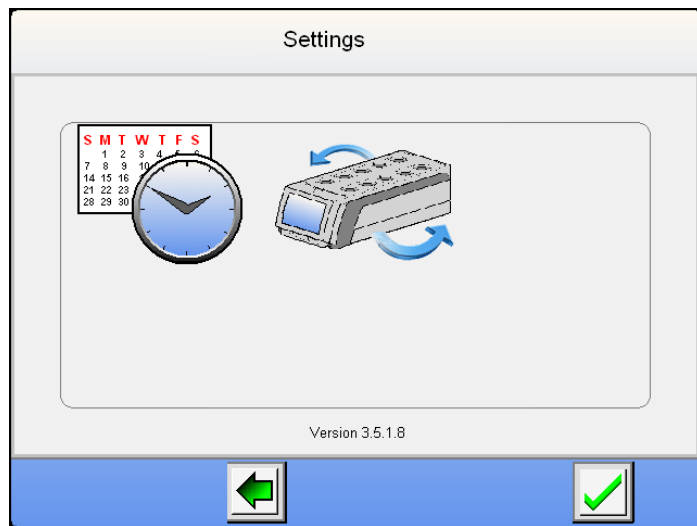
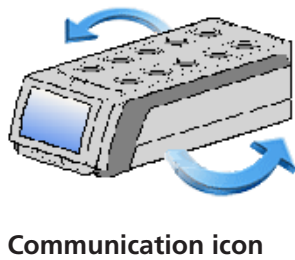

From selection screen touch the GSIOC facility selection.

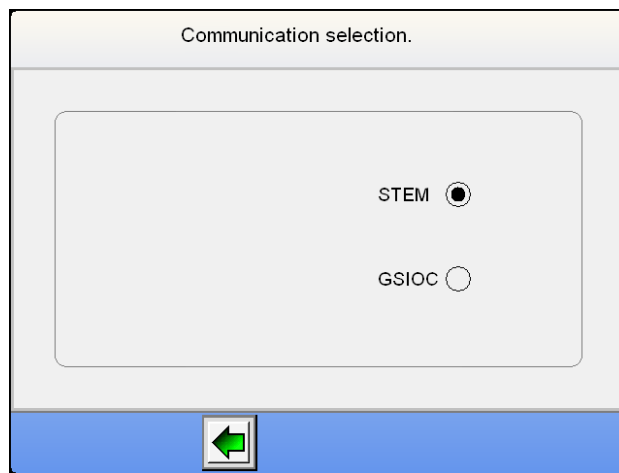

Once the settings protocol has been changed the Integrity 10 must be switched off and then turned back on before the new settings will become active.

Unless using this equipment with GSIOC protocol enabled systems leave the communication protocol set for STEM.

## 7.9. View firmware release set

From the home screen touch the settings icon to access the settings screen. The software version set number is displayed across the bottom of the settings screen.

To check you have the latest software version, please contact [cpervice@coleparmer.com](mailto:cpervice@coleparmer.com).

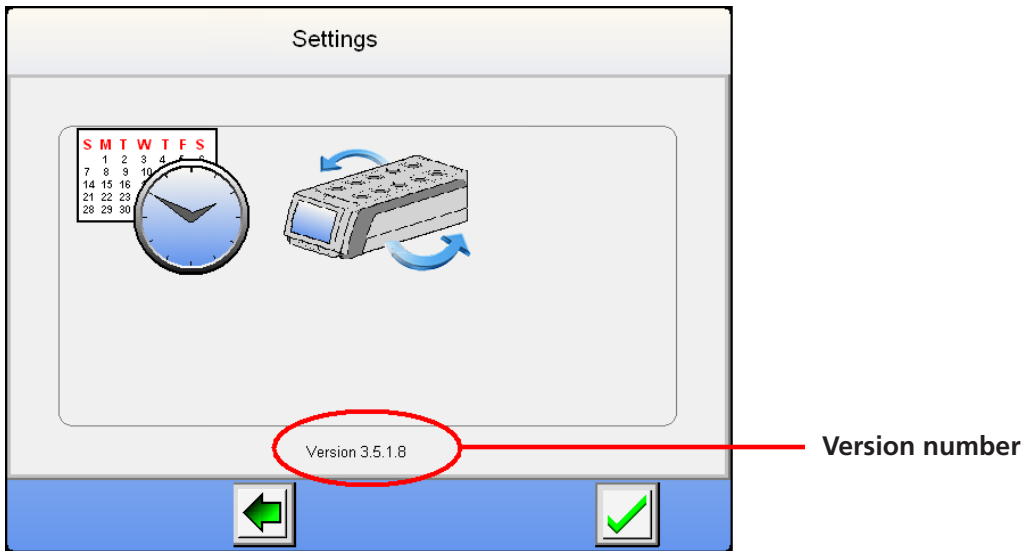

Press the green back arrow to return to the home menu.

### 7.10. Manual control

This view of the Home Screen is typical of the Integrity 10 without any cell position operational.

The graph area will represent real time data when the unit is running.

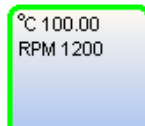
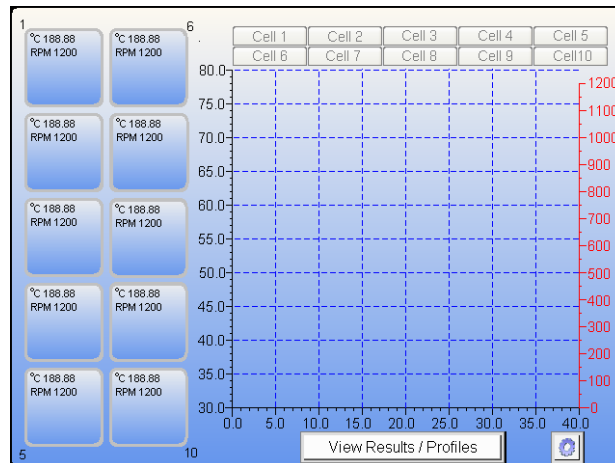

*A highlighted cell button showing real time temperature and stir speed*

**Individual cell adjustment and settings:** By touching any one of the cell position buttons the correlating cell can be set to run in manual control or profile mode as determined by the user.

The user is now prompted to select whether they wish to run the Integrity 10 in 'Manual Control' or 'Profile Mode'. Select 'Manual Control' by lightly touching the button position on the touch screen panel.

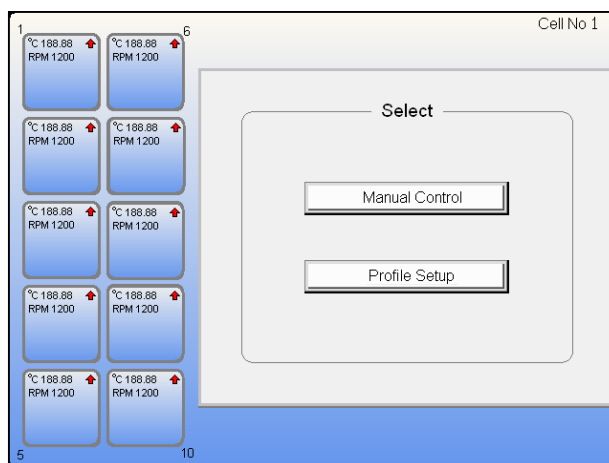

**The temperature field must be filled however all other fields are optional.**  
 Greyed out fields indicate an optional setting.

### 7.10.1. Setting the temperature

Touch the field box on the display screen to enter a setting into the appropriate field. To enter a temperature setting, touch the temperature field box.

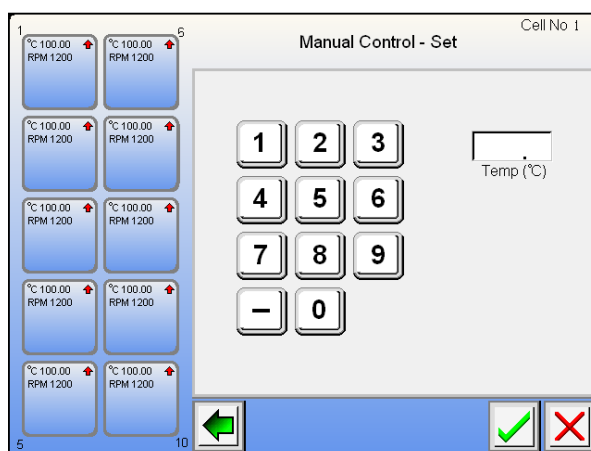
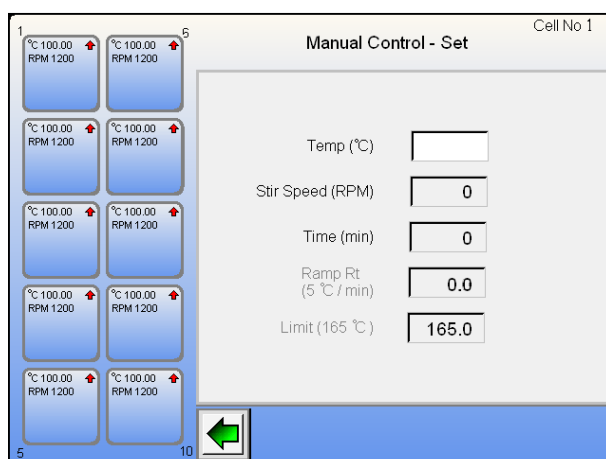

Use the keypad to enter the required temperature setting. Press the  button to accept the value entered.

Touching the  button will remove the setting entered in that field.

**Note:** When a temperature value has been entered both Ramp rate and Upper limit fields may be selected.

### 7.10.2. Setting the stir speed:

Touch the Stir speed field.

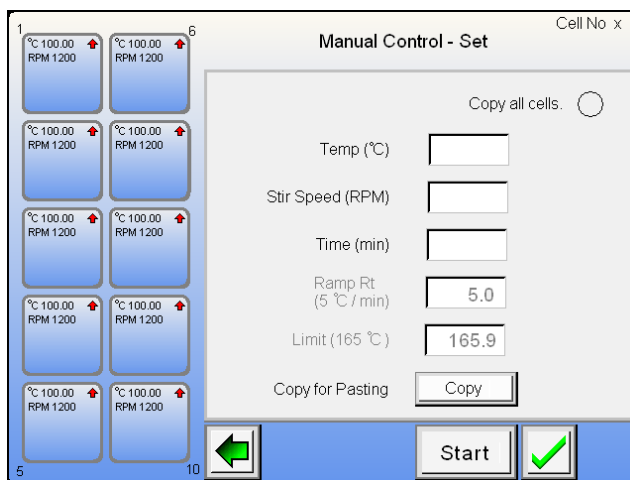

As with the process for entering a temperature you may enter the stir speed using the key pad.

Press the  button to accept the value entered.

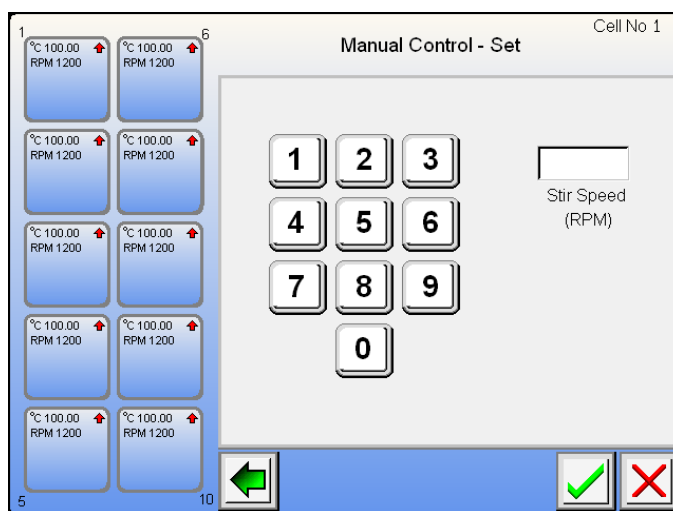

### 7.10.3. Setting the run time

The length of time the user wishes the unit to run the cell for is set via this field. By touching the 'Time' field a run time period may be set. Enter the required run time in minutes. Example, 4 hours 25 minutes is 265 minutes.

**Note:** The maximum run time entry is 9999 minutes = 166 hours and 39 minutes.

Press the  button to accept the value entered.

### 7.10.4. Setting the ramp rate

The optional field of Ramp rate may be changed using the same procedure. Touch the field box to select the setting keypad.

**Note:** The default setting for ramp rate is 5.0°C per minute. Graduations can be set as low as 0.1°C per minute. When 0.0 is entered, **maximum ramp rate is achieved** as default, however, this is uncontrolled ramping.

Enter the required ramp rate using the keypad. Press the  button to accept the value entered.

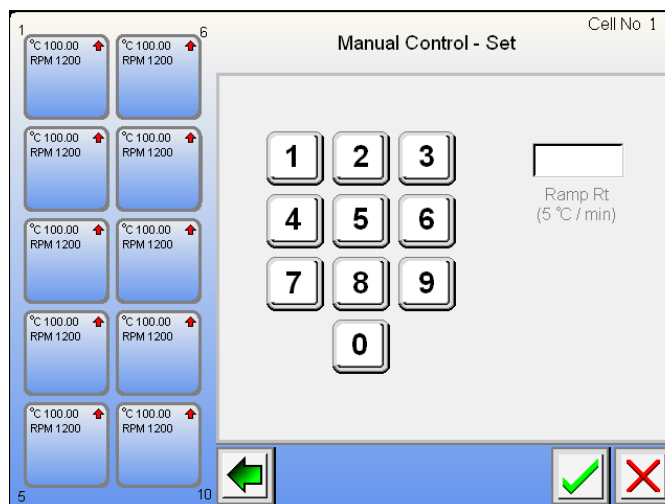

### 7.10.5. Setting the maximum upper limit

To help control an exothermic reaction a maximum upper temperature limit may be set. When the Integrity 10 senses an unexpected change in temperature state, action will be taken to prevent the change exceeding the set maximum temperature limit. The set default of this field is 165.0°C.

Enter the setting using the keypad. Press the  button to accept the value entered.

### 7.10.6. Copy function

Once the user has completed entering all the required field entries the entered settings may be copied over into another cell. Touch the copy button  to write the settings to the internal clipboard.

Pressing back will now show the home screen. Touch the cell you wish to paste the value into and the fields will have the copied value filled in.

You may now press  The cell will commence running as per the inputted settings.

**Copy all:** By selecting the copy all check spot  Copy all cells.  and selecting the green tick all the setting made are automatically copied into all the other vacant cell positions.

**If 'copy all cells' is selected pressing 'start' will cause all cells to commence operation. The home screen is then displayed.**

**Note:** The Paste button is only visible once the copy button has been selected.

### 7.10.7. Adjusting the settings of a running cell in manual control

Touch the active cell button for adjustment. The screen will ask you to 'Turn cell off' or 'Adjust setting'.

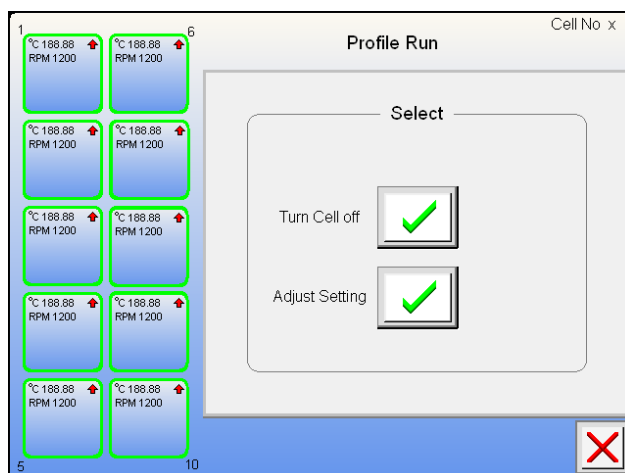

Touch the adjust button and then select the 'Manual control' from the next screen.

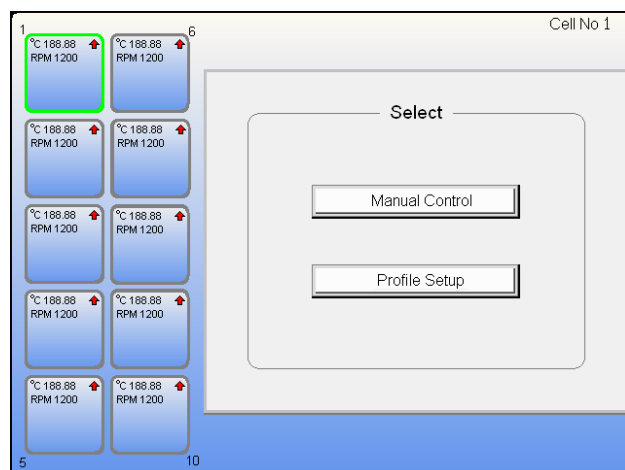

Select the field or fields to be adjusted as per the original run setup.

Check the 'All cells' spot Copy all cells.  if you wish to apply the change to all cells, or touch the copy button for pasting the change into selected other cells.

Touch the  button to accept and commence running the change.

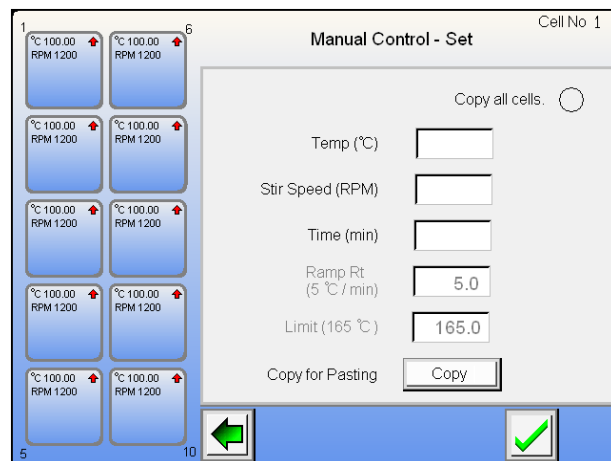

**Note:** The 'Start' button isn't visible when adjusting a running cell

### 7.10.8. Home screen when operational

Shown in this example is a typical home screen with all the cells operational. The graph on display is from cell 2. To change the graph view between cells, touch the cell number at the top of the graph.

**Note:** If a cell is not operational it will not be possible to select the tab.

By touching the graph screen area it is possible to toggle sequentially from one screen to the next operational screen in ascending order.

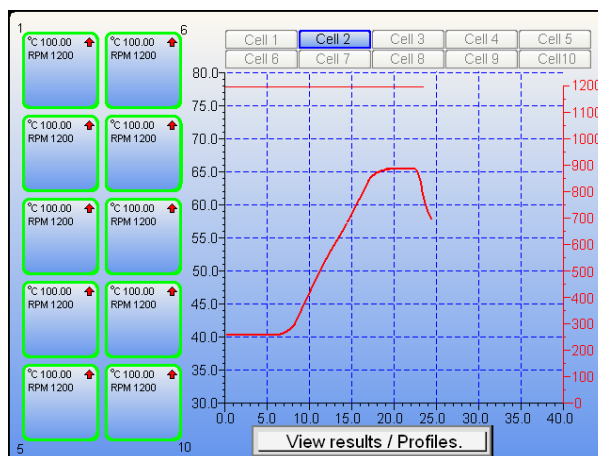

The graph is accumulative and will auto rescale as a cell is run.

When a green band is seen around the cell, this indicates the cell has a setting written to the field(s). The cell may not be running but it has been set ready for operation.

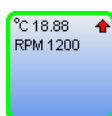



A red band around the cell indicates the cell has finished a run and associated activities are complete. See section 7.14 'Saving an Experiment'. Once the cell has finished, the experiment must be either saved or deleted before the cell can be used again.



A grey band indicates that the cell is not in use and that no data is sitting behind awaiting a storage decision.

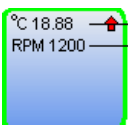

#### On screen symbols

-  Cell temperature increase.
  -  Cell temperature decrease.
  -  Control by contents
- 

The real time temperature and stir speed are shown within the cell box.



## 7.11. Profile control

**Note:** It is possible to have some cells running in profile mode while others are running via manual control.

A profile will allow the user to set up and run a step cycle and if required repeat that same cycle as many as 10 times (when using the optional Integrity PC software this is increased to 999 times).

### 7.11.1. Profile set up

From the home screen, touch the required cell the profile is to be set up in.

This time select the 'Profile setup' button.

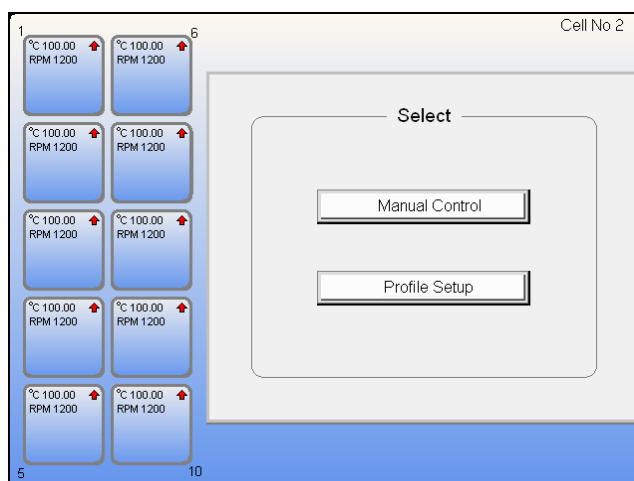

This next screen shows a profile step. To complete the profile all fields must be completed. Once a field has changed from a grey state it can have setting parameters added and amended. The screen layout is intended to visibly show the steps required to complete a profile setup.

**Note:** It is possible to set up a profile that is the inverse of the one displayed by selecting a target temperature below that of the initial temperature.

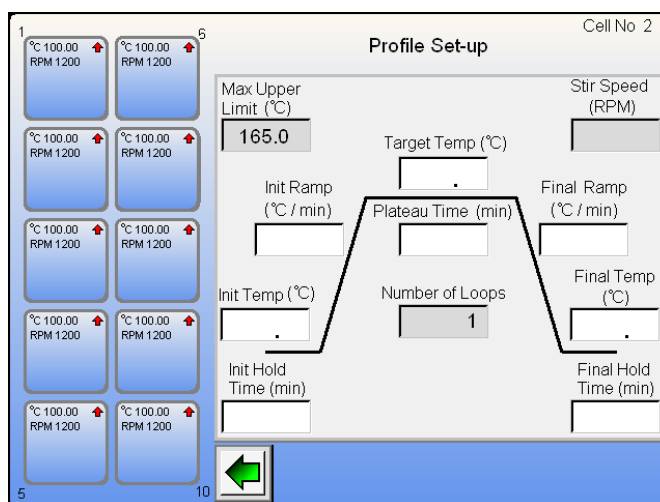



### 7.11.2. Setting the initial temperature

Touch the initial temperature field to activate the field input screen. Use the keypad to input your required start temperature. The initial start temperature is the temperature you wish the profile to commence from. It can be different to the ambient temperature of the cell.

**Note:** To enter -25.6°C Press 2, then 5, then 6, followed by the minus sign.

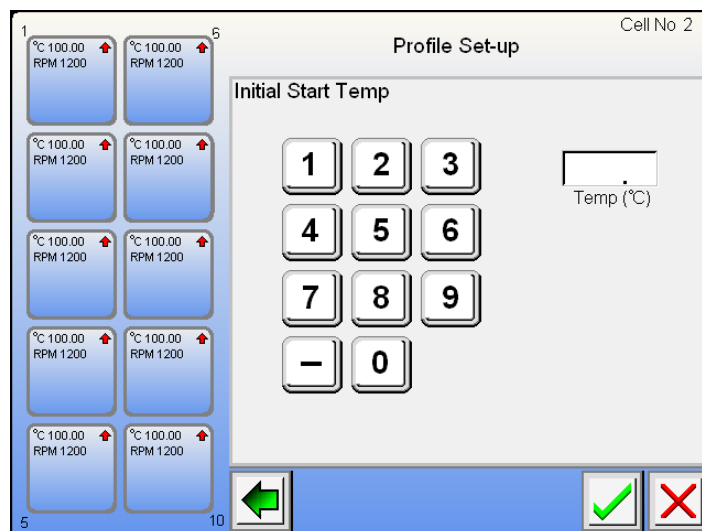
**Note:** the - minus symbol will only appear when you start entering the temperature.



As with manual control the  will take you back to the previous screen. The button is used to accept a value and the  is used to remove an incorrect field entry. Use the keypad to enter your initial start temperature.

### 7.11.3. Setting the initial hold time

This is similar in operation to the previous field. Touch the field to enter the required setting. All white field boxes must have a value entered. Grey field boxes are optional settings and do not need to have a setting entered.

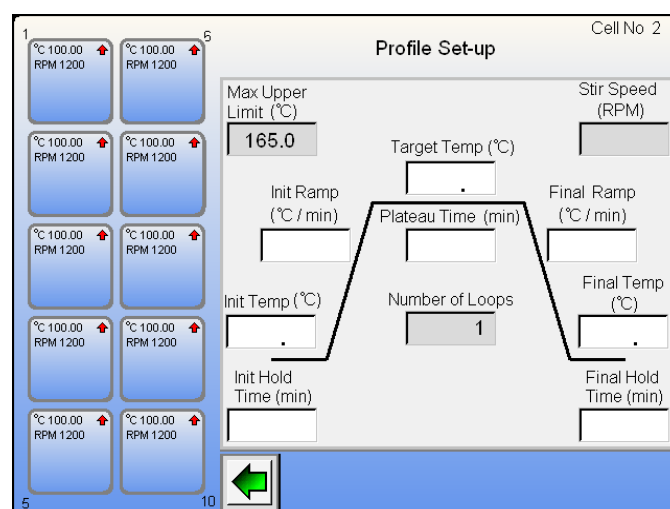

Use the keypad to enter the time value (minutes) for the length of time you wish the initial temperature to be held at.

**Note:** Enter the time in minutes. **Example,** 4 hours 25 minutes is 265 minutes.

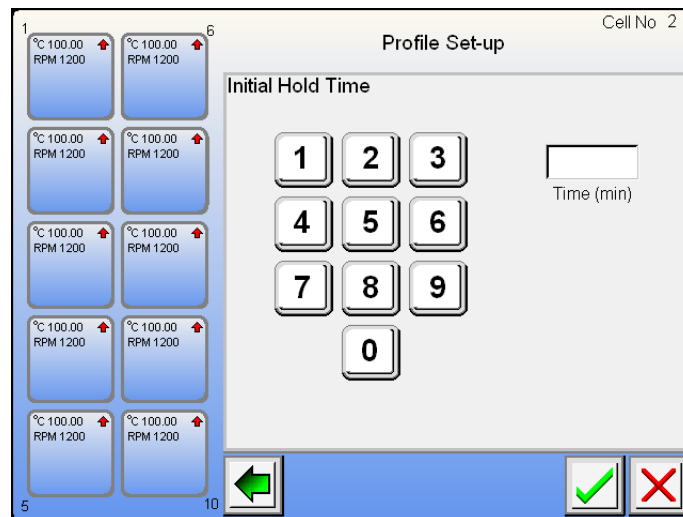

Touch  to accept the time entered in the initial hold time field.

#### 7.11.4. Setting the initial ramp

The initial ramp rate is the rate of temperature change required. The initial ramp may be set to decrease in temperature as well as increase. Touch the field to enter the required setting.

**Note:** The default setting for ramp rate is 5.0°C per minute. Graduations can be set as low as 0.1°C per minute.

**When 0.0 is entered the ramp rate will climb as rapidly as possible to the desired target temperature.**

Use the keypad to make the field entry. Touch the  button to accept the value set.

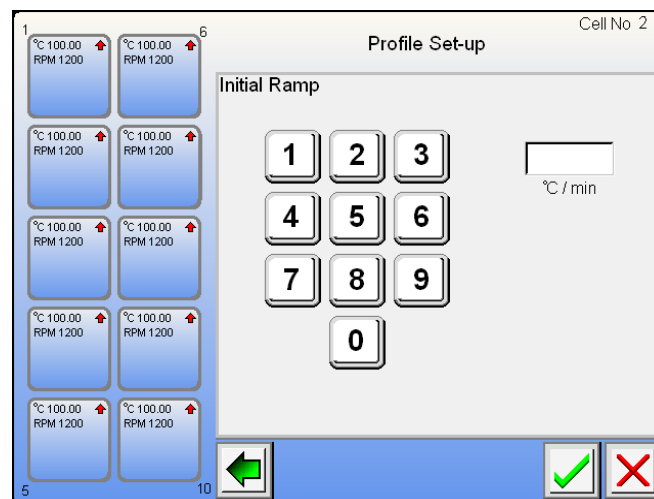

#### 7.11.5. Setting the target temperature

The target temperature is the temperature the user wishes the profile to attain. **This can be a minus temperature as well as a positive one.** Touch the field to enter the required setting.

Use the keypad to make the field entry. Touch the  button to accept the set value.

**Note:** To enter -25.6 Press 2, then 5, then 6, followed by the minus sign.

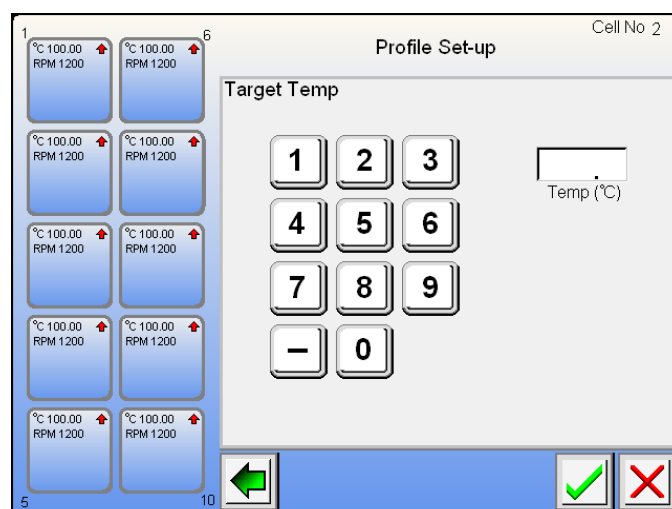

### 7.11.6. Setting the maximum upper limit

To help control an exothermic reaction a maximum upper temperature limit may be set. When the Integrity 10 senses an unexpected change in temperature state, action will be taken to prevent the change exceeding the set maximum temperature limit. The set default of this field is 165.0°C.

Enter the setting using the keypad. Press the  button to accept the value entered.

**Note:** The maximum upper limit may be set to a minus Celsius value.

To clear the data field touch the 'red cross'. If you no longer wish to set a maximum upper limit, touch the back button to return to the previous screen and then touch the 'red cross'.

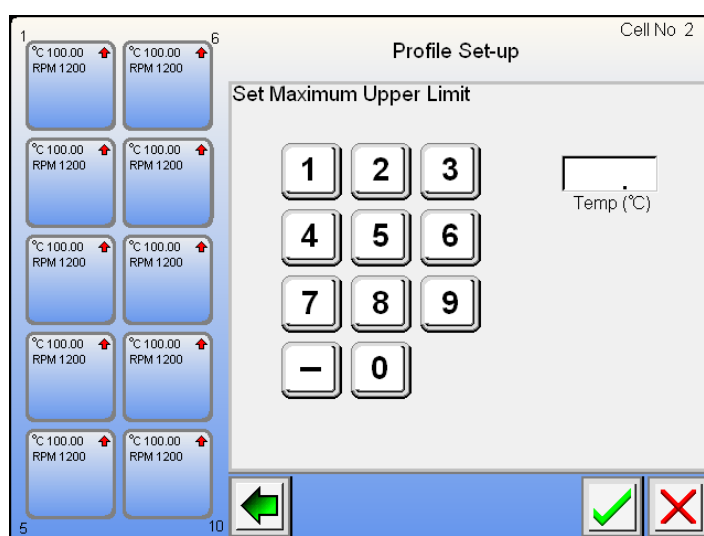

**Note:** To enter -25.6°C Press 2, then 5, then 6, followed by the minus sign.

### 7.11.7. Setting the plateau time

This is the length of time the user wishes to have the unit run at the target temperature. The data field requires the user to enter a time in minutes.

**Note:** Enter the time in minutes. **Example,** 4 hours 25 minutes is 265 minutes.

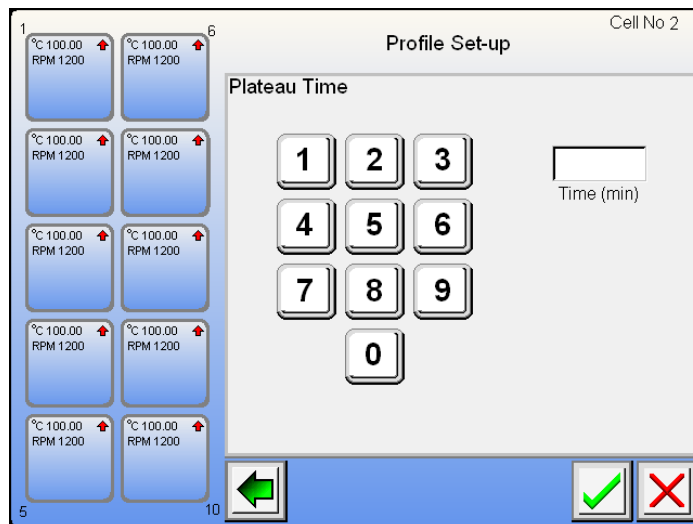

### 7.11.8. Final temperature

The final temperature is the temperature at which the user wishes the profile to conclude the final step at. Touch the field to bring up the keypad for entering the required settings.

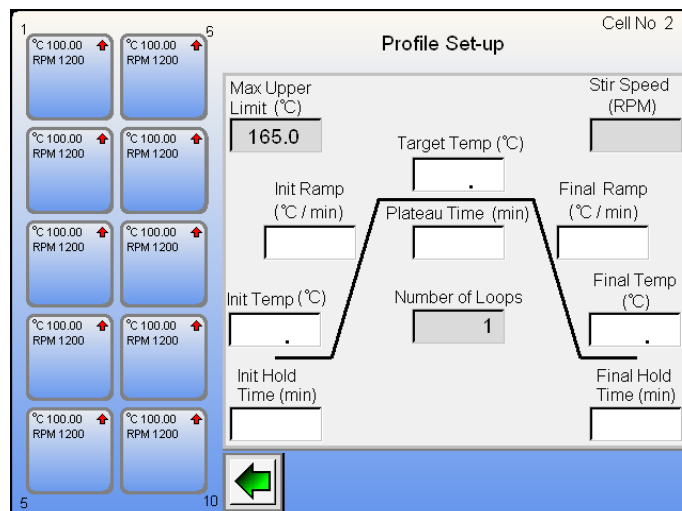

Use the keypad to enter the final temperature value. ***This can be either a positive or negative value.***

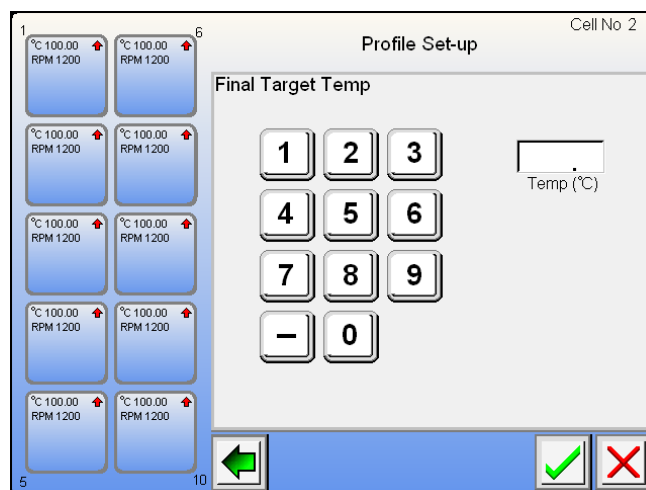

**Note:** To enter -25.6 Press 2, then 5, then 6, followed by the minus sign.

### 7.11.9. Final ramp

The final ramp is the rate of temperature change from the target temperature to the final temperature. The final ramp rate can be set to either increase or decrease in temperature. Touch the field to enter the required setting.

**Note:** The default setting for ramp rate is 5.0°C per minute. Graduations can be set as low as 0.1°C per minute.

**When 0.0 is entered the ramp rate will climb as rapidly as possible to the set target temperature.**

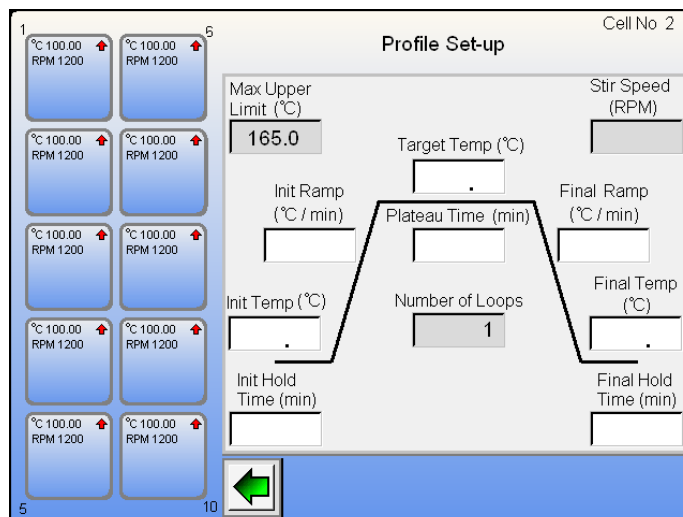

Use the keypad to make the field entry. Touch the green tick button to accept the set value.

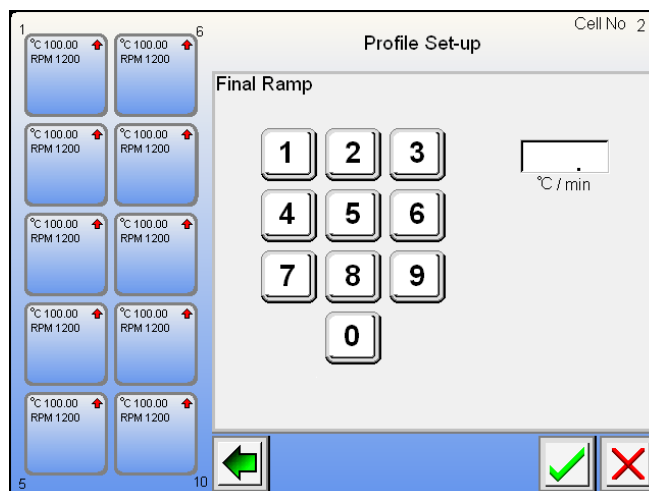

### 7.11.10. Setting the hold time

This is the time at which the user wishes to hold the final temperature, after which the user can choose to either stop the run or repeat the profile on a loop setting.

Use the keypad to enter the hold time value in minutes.

**Note:** Enter the time in minutes. **Example,** 4 hours 25 minutes is 265 minutes.

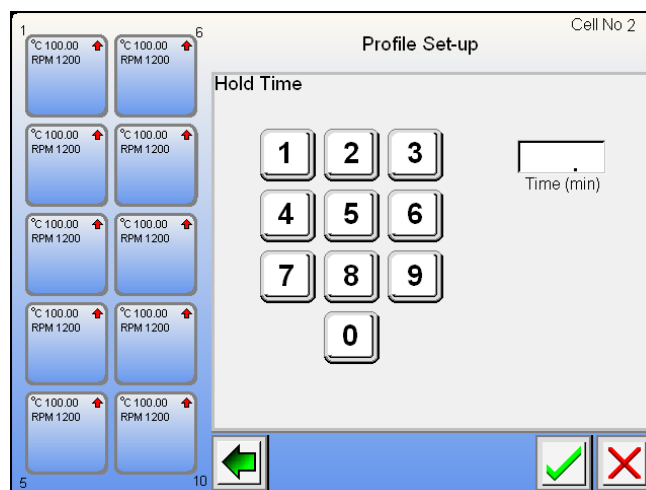

### 7.11.11. Stir speed

The stir speed is set to 0 RPM by default. At this setting the stir facility is turned off. Turn the stir function on by entering a value. The lowest stir speed that may be selected is 350RPM. The maximum stir speed value that may be set is 1200RPM.

Touch the field to enter a value.

Use the keypad to enter a stir speed value.

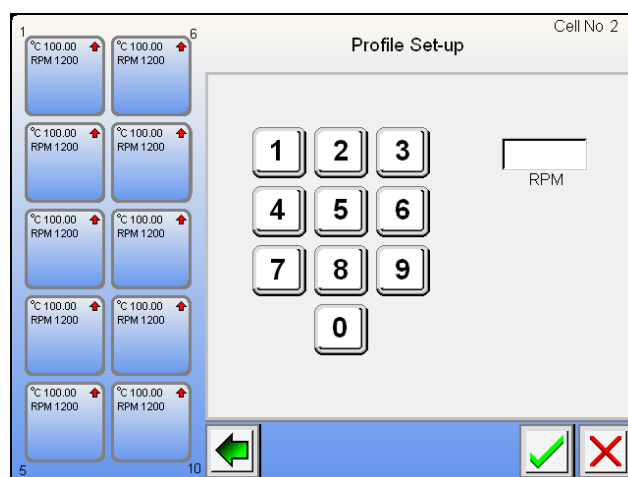

### 7.11.12. Profile loop

By selecting the profile loop the user is given the facility to enter the number of times they wish to loop the profile. The default value for number of loops is set to 1. To change the number of times the profile is repeated, touch the field box and use the keypad to enter the desired value.

**Note:** A maximum of 10 loops may be set per profile. (When using the optional Integrity PC software, this is increased to 999 times).

**Note:** The start temperature for all subsequent loops will be the same temperature as the finish temperature of the preceding loop.

Touch the back arrow to return to the ramp loop selection screen.

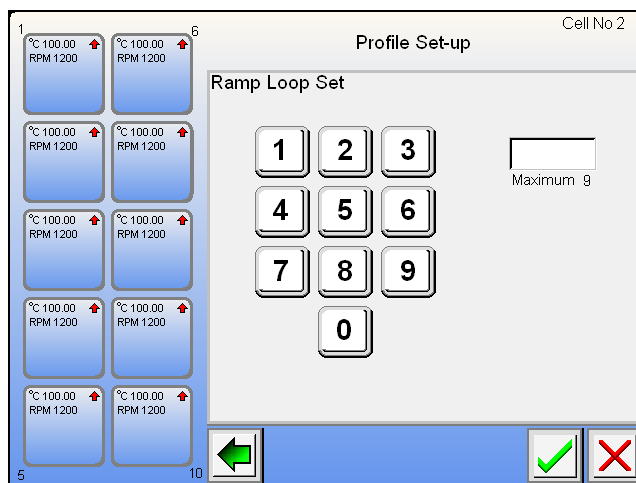

You are now presented with the final setting screen from which any changes may still be made by touching the relevant settings field. The user has the facility to select 'Save profile'. From here the user is taken through menu screens which enable the user to store the profile so that it may be used at a future date. (See 'Save Profile'). The user may select to copy the profile to the clipboard so that it can be pasted into other cell profiles. Touch the green tick to return to register the entry and return to the profile screen.

### 7.11.13. Copy and paste a profile

Once the copy button has been pressed this profile is copied to the internal clipboard and can be pasted into other cells as per 7.10.6.

Touch the Start button to commence running the profile or touch the green tick to accept the profile settings. Both functions will take the user to the main Home screen. From the home screen touch the cell you wish to paste the copied profile to.

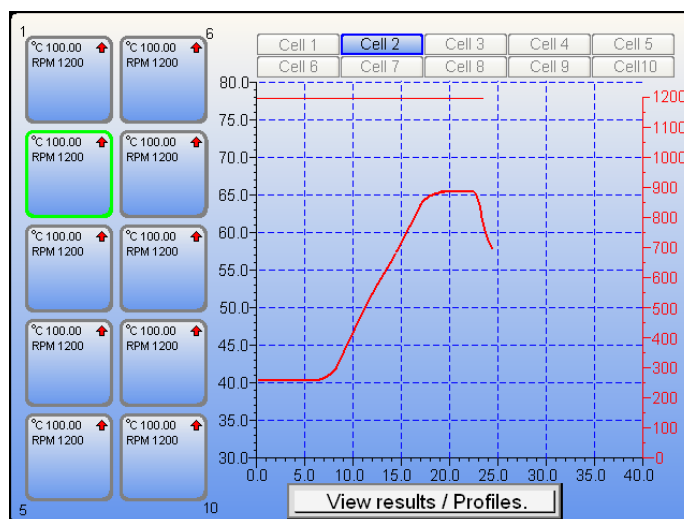

Touch the 'Paste' button to load the saved profile setting into this cell. Once the new profile has been populated you have the same editing facilities as per the original profile. Simply touch the required field for editing and use the keypad to re-enter data. Touch the green tick to commence cell operation and return to the home screen. If you decide to remove the pasted profile, touch the 'red cross'.

**Note:** The saved profile remains on the clipboard. You may select another cell and paste the profile into it.



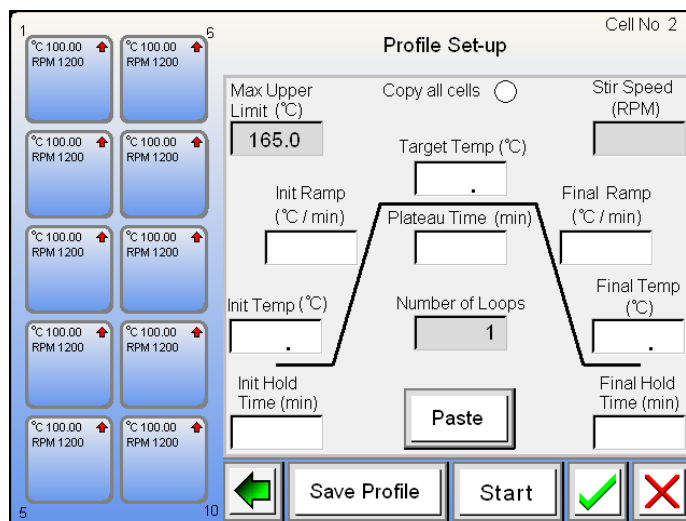

#### 7.11.14. In the event of power loss

The Integrity 10 will turn off. All field settings will be lost. Part written data may be extracted manually from the SD card using an SD card reader. All previously stored data written to the SD card will be safe.

#### 7.12. Naming and saving a profile

The profile that has been set in section 7.11. may be named. In addition, extra information about the nature and composition of the experiment may be added. This profile setting information can be recalled at any time in the future and reloaded into any given cell position in order to re-run the profile. Naming and storing profiles may be undertaken while other cells are in operation.

**Note:** This feature is only available as an option from the profile setting facility.

To save the profile settings touch the 'Save Profile' button 

You are now taken to the field selection screen as illustrated below.

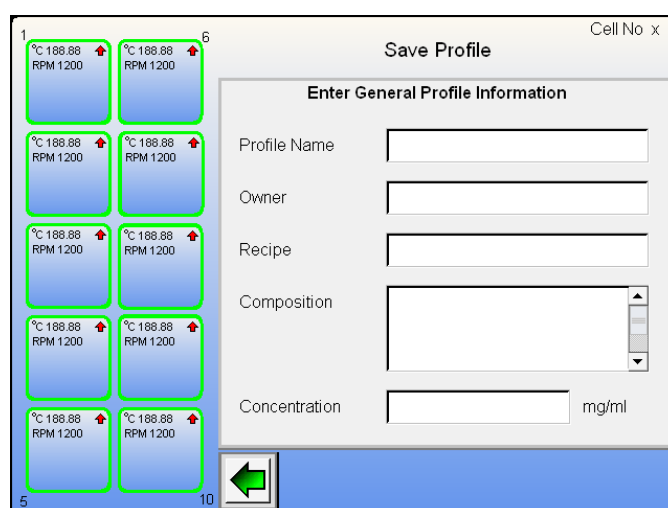



The fields can be completed in any order. **All fields must be completed before the profile can be saved.**

Touch the required field position to be taken to the respective data input screen.

The back button  will take you back to the previous screen.

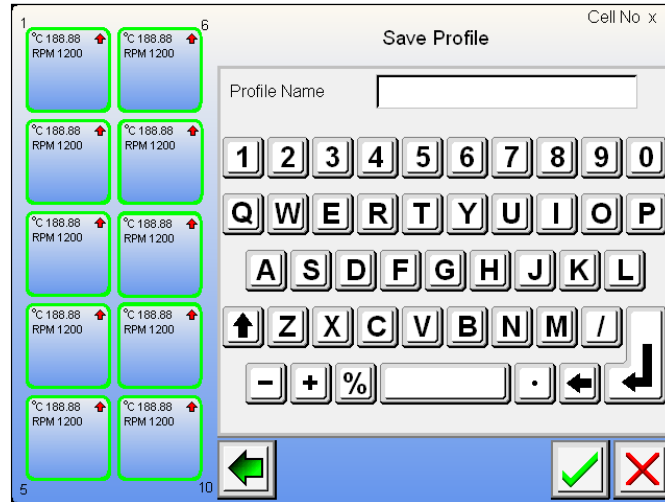
**Profile Name:** From the screen below use the keyboard to name the profile.



The back button  will take you back to the previous screen. Use this button  to remove an incorrect field entry.

This  button is used to accept the field entry. By touching this button the field entry is accepted. You are taken back to the Profile field selection screen.

Using the same method fill in the 'Owner', 'Recipe', 'Composition' and 'Concentration' fields.

Upon completion within the save profile screen a green tick is now shown. Touch the tick button to accept the field entries and save the profile.

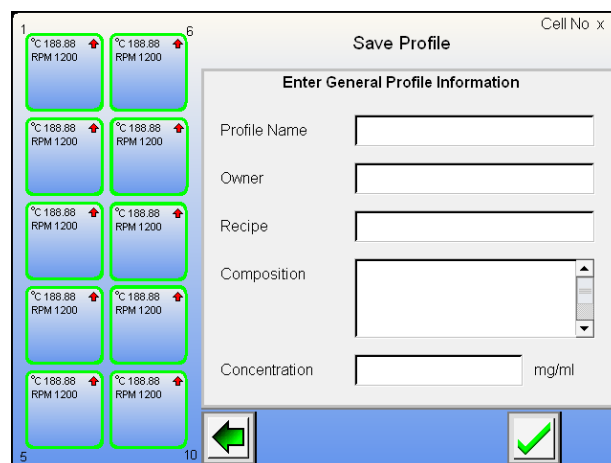

To edit any of the fields touch the respective field and edit using the keyboard.

### 7.13 Stored profile view and copy

The concept of stored profile retrieval is to call up any stored profile and view its field entries as entered in section 7.12. Furthermore all of the profile settings can also be viewed. It is also possible to select and copy a stored profile which can then be pasted to any vacant cell position. All profile settings may be edited and if required the profile can be renamed and edited and stored as a new profile.

Stored profiles can be viewed at anytime regardless of what other functions the Integrity 10 is performing. The only exception to this is when the screen is locked because of an external control source. See section 7.18.

**Note:** A profile can't be stored once the associated experiment run has been completed. It can only be stored before and during the run of an experiment.

All of this may be undertaken while other cells are in use.

#### 7.13.1. Storing a profile

From the home screen, with or without any cells in use touch the 'View results / Profiles'  button.

The next screen asks the user if they wish to view stored profiles or view stored experiment data. To view a stored profile touch the tick button associated with the stored profile statement.

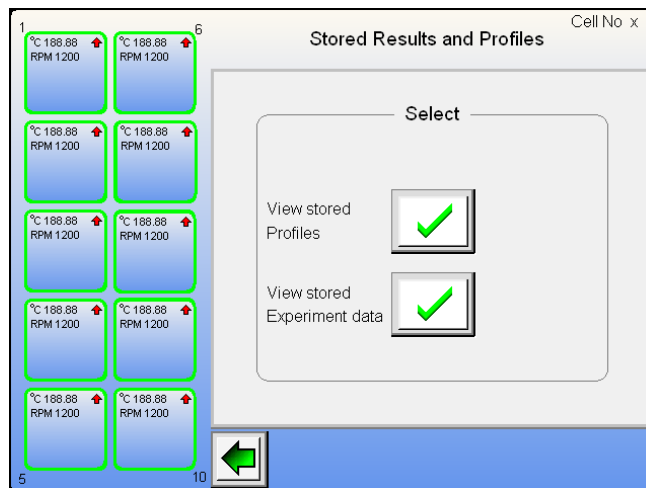

**Note:** The back button  will take you back to the home screen.

All stored profiles will appear in a list box as shown below. They appear alphabetically and are listed by profile name.

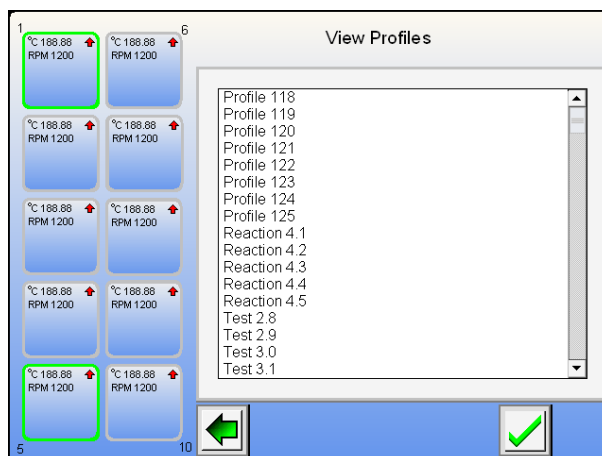

(Example of named profiles)

Touch the profile title to be viewed. It will then become highlighted.

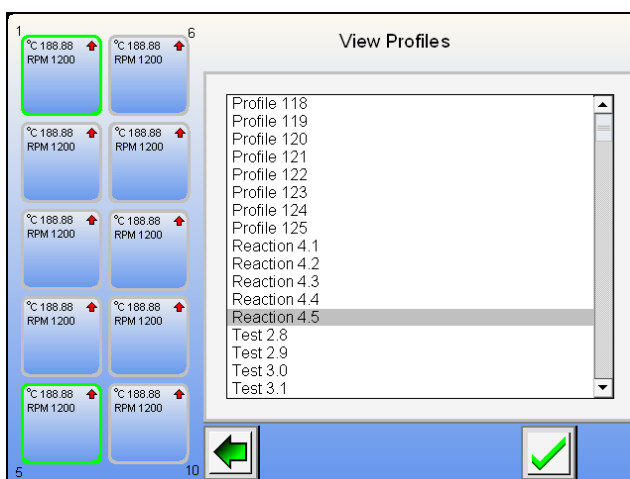

Touch the green tick button  to accept and view selected profile.

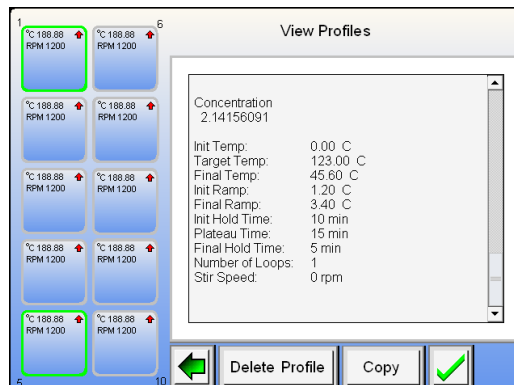
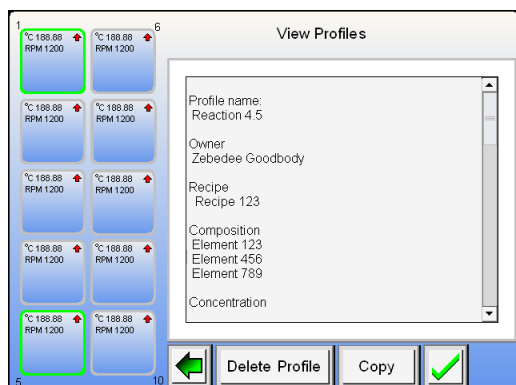

You are now able to view the selected profile. Scroll down using the scroll bars to view the profile settings as well as named field entries.

Touch the green tick  button to return to the profile selection screen.

Touch the green back arrow  button to return to the home screen.

To copy the profile into other cells touch the 'copy' button . The profile is now copied to an internal clipboard.

Touch the cell button that is to have the profile copied to.

**Note:** Ensure the cell selected is one that is not in operation.

Touch the Profile Setup button to bring up the profile entry field screen.

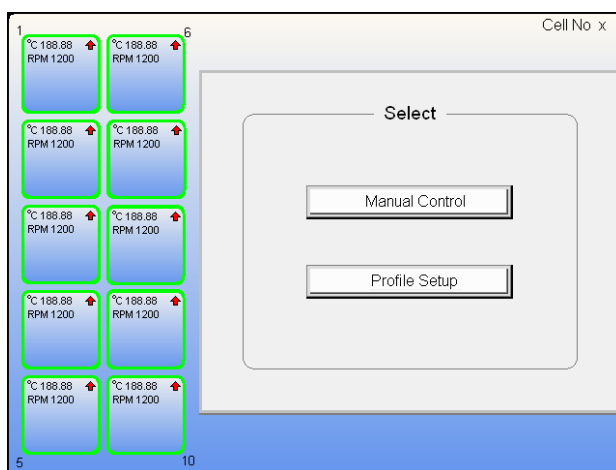

Touch the paste button to populate all the fields with the copied profile settings.

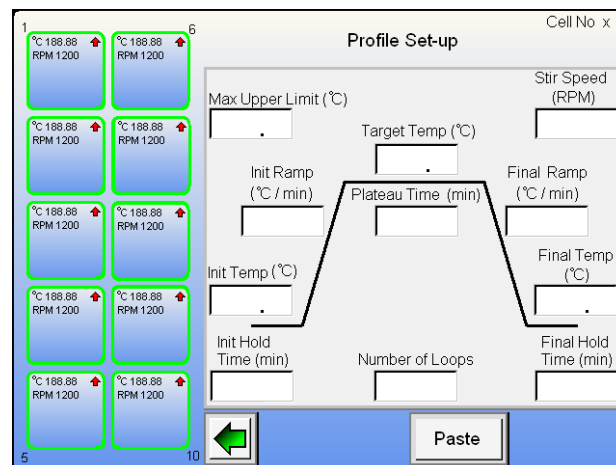

Touch the green back arrow  button to return to the home screen in order to select a different cell.

### 7.13.2. Delete a stored profile

From the profile information display screen touch the 'Delete Profile' button.

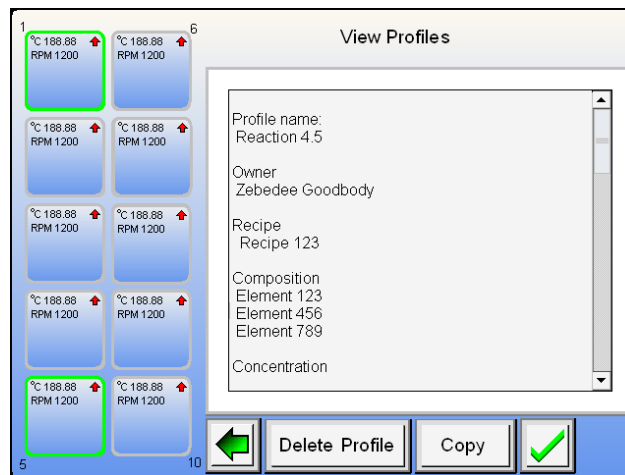

Touch the green tick to delete the profile. Touch the 'red cross' to cancel the profile deletion.

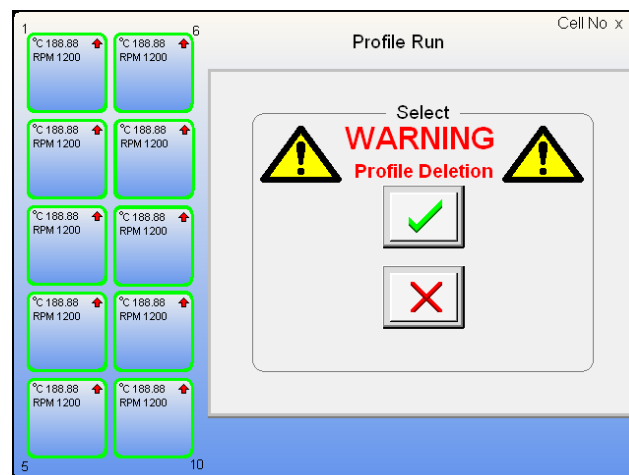

## 7.14. Saving an experiment

Stored experiments are time and date stamped. You should ensure the clock settings are correct (**See section 7.7.**).

The principle difference between saving a profile and saving an experiment is that a profile is saved when it has been created. A profile cannot be saved once the associated experiment run has been completed.

An experiment can only be saved once it has completed its run. An experiment can be saved from both the profile setup or manual control modes.

When an experiment run is complete or the experiment has been stopped a red ring is displayed around to the cell button. To clear the ring and use the cell again the user must either save the experiment data or decline the save experiment option. This is done firstly by touching the cell button highlighted with a red ring

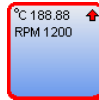

You will now see the screen as illustrated below.

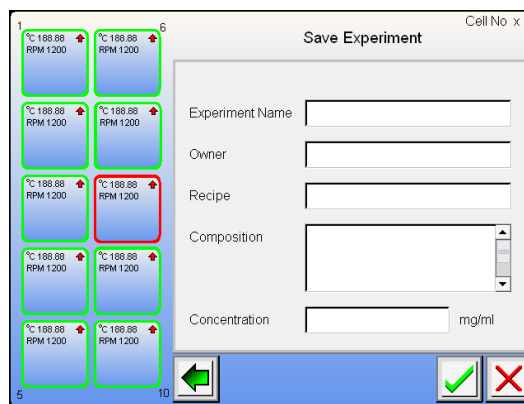



Touch the required field position to input the respective entry.

The back button  will take you back to the home screen.

**Note:** The fields can be completed in any order.

**Experiment name:** Use the keyboard to input the experiment name.



The back button  will take you back to the home screen. Use the  button to remove an incorrect field entry.

The  button is used to accept the field entry, by touching this button the field entry is accepted and the user is taken back to the experiment field selection screen.

Complete the Experiment Owner, Recipe, Composition and Concentration fields using the same method as above.

**CLEARING A CELL WITHOUT SAVING DATA:** Touch the highlighted cell button.

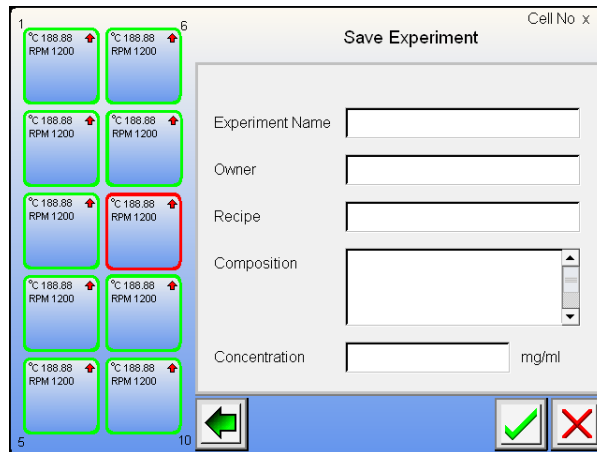



Now press the Red cross button. 

**Note:** If the fields are filled touching this button will clear out all field entries.

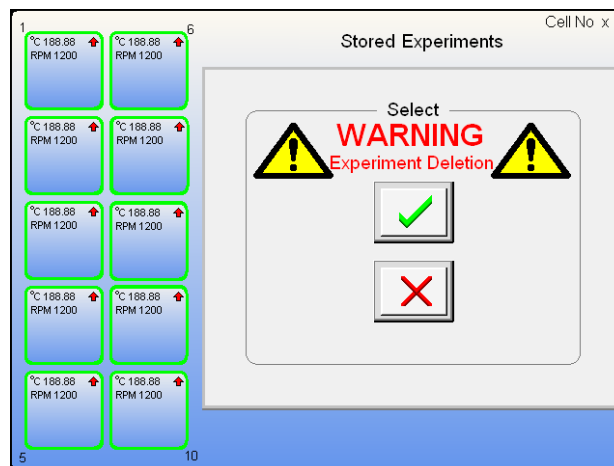
If all the fields are blank then you are taken to the following cancel operation screen as illustrated.



Touch the green tick  to accept data cancellation or the 'red cross'  to return to the field entry screen.

The red cell ring will change back to grey. The cell is now ready for further use.



## 7.15. Reviewing stored experiment data

Stored experiment data can be viewed at anytime regardless of what other functions the Integrity 10 is performing. The only exception to this is when the screen is locked because of an external control source. See section 7.18.

### 7.15.1. Accessing stored experiment data

From the home screen, with or without any cells in use, touch the

'View results / Profiles'  button.

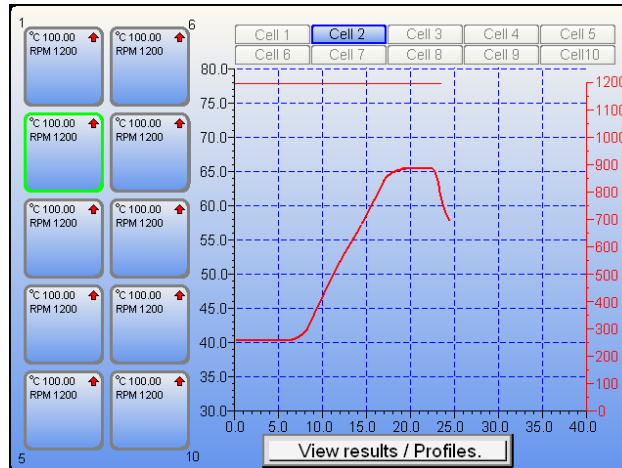

The next screen asks the user if they wish to view stored profiles or view stored experiment data. To view Stored Experiment Data touch the tick button associated with the stored profile statement.

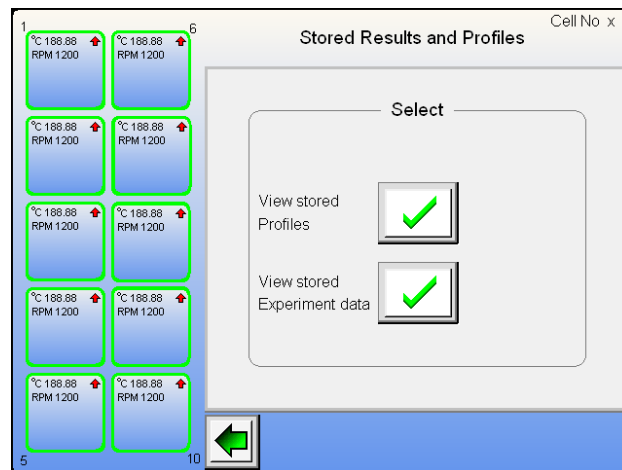

Note: The back button  will take you back to the home screen.

You are now taken to the screen as illustrated below.

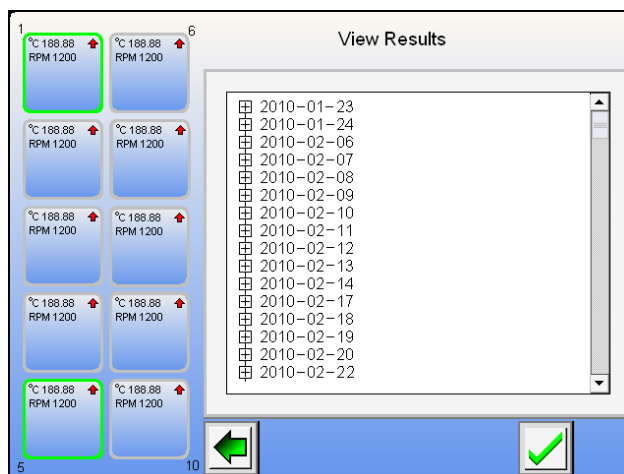

Each date in the cascade tree can be expanded by touching on the expansion button. 

From here you can view all the stored experiments for that date. Touch the expansion again to close the cascade.

Select the experiment to be viewed by touching on it to highlight it. Confirm the selection by touching the green tick.

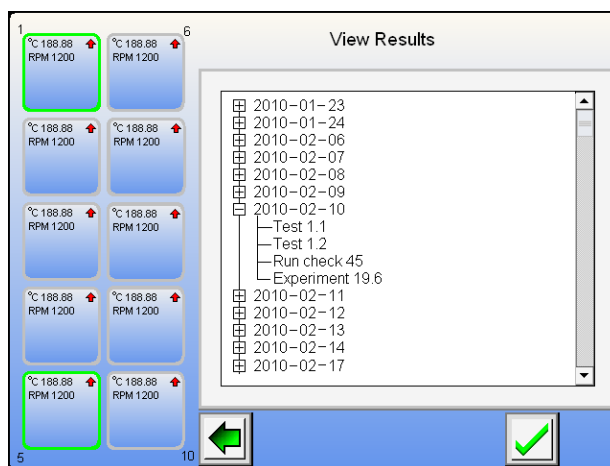

Use the scroll bars to view all settings and title information associated with the experiment.

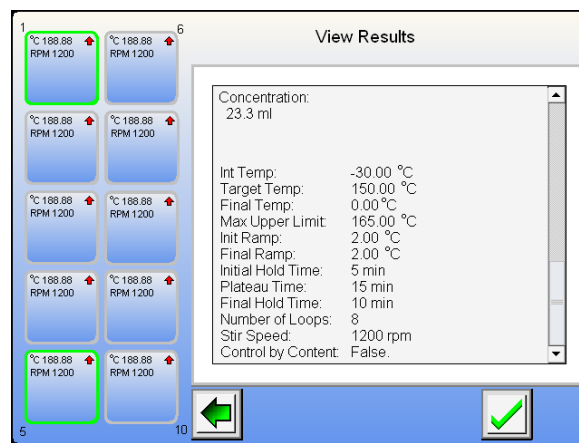
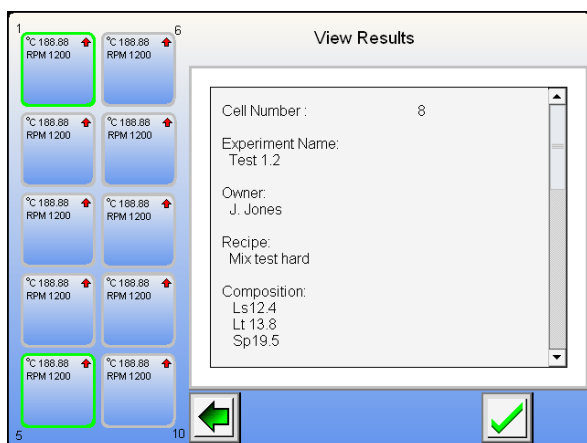

Touch the green tick button to view the raw recorded data.

The screen will look like the illustration below.

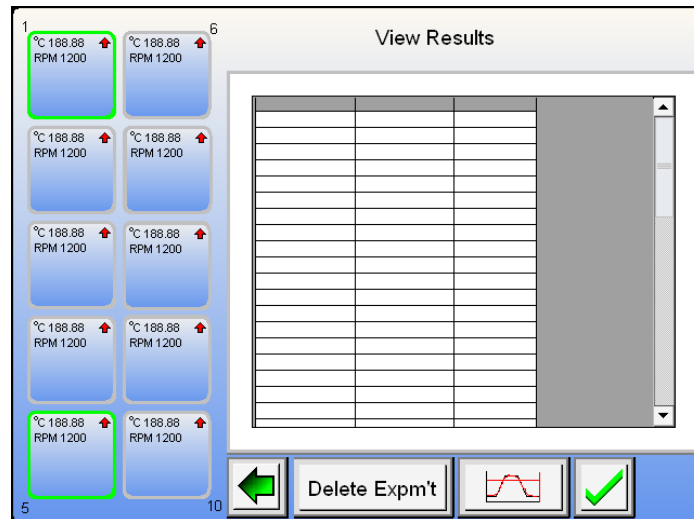

### 7.15.2. Viewing data in graphical format

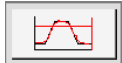
Touch the Graph button  to view the data presented in a graphical format.

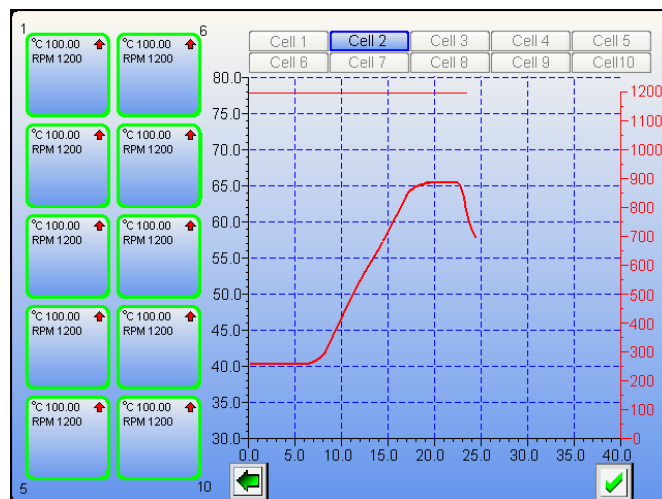

To return to raw data format, touch the  green tick button.

### 7.15.3. Deleting experimental data

From the raw data screen touch the Delete Experiment button . You are now asked to confirm experiment deletion. Touch the green tick to accept or the red cross and return to the raw data screen.

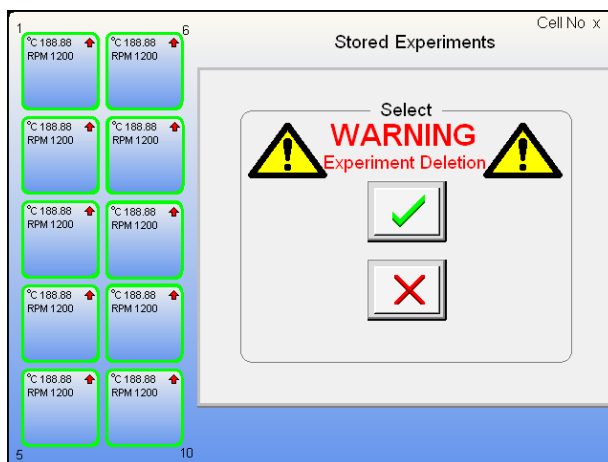

### 7.16. Outputting stored data via USB flash drive

Select the view experiment set-up or the Raw Data Screen (see section 7.15). Insert a USB Flash Drive into the master USB socket found on the front of the Integrity unit (see 7.1). After 10 seconds or less the USB download button will appear on the screen.



Touch the button and the raw data and a 'read me' file containing the experiment parameter settings will automatically download.

Once the download is complete a download statement will appear confirming its completion. Touch the OK button. It is now safe to remove the USB flash drive.

**The raw data may be viewed by opening in Microsoft Excel. The read me file is a Microsoft notepad file.**

## 7.17. Control by contents

### (Using the optional Electrothermal ATS10001 Multi-Temp module)

 **Ensure the Integrity 10 is turned off before commencing the installation of Multi-Temp**  
Use the Multi-Temp instruction manual (M7559), in conjunction with the Integrity 10 instruction manual.

  **ATTENTION** Do not install the Multi-Temp on a surface which may become wet as the result of using chilled water.

The Multi-Temp is used when accurate control of the sample temperature is imperative. The Multi-Temp is used to control the contents temperature. Thermocouples placed in the chemical solutions are connected to the Multi-Temp which feeds back constant information on the exact sample temperature. The Integrity 10 measures the temperature from the thermocouples via the Multi-Temp then adjusts and monitors the sample temperature according to the temperature settings under both manual and profile control.

#### 7.17.1. Installation of the Multi-Temp

Take the Multi-Temp unit (ATS10001 optional accessory) and connect it to the Integrity 10 unit. Plug the 'D' type connector into the RS232 port found on the rear of the Multi-Temp.

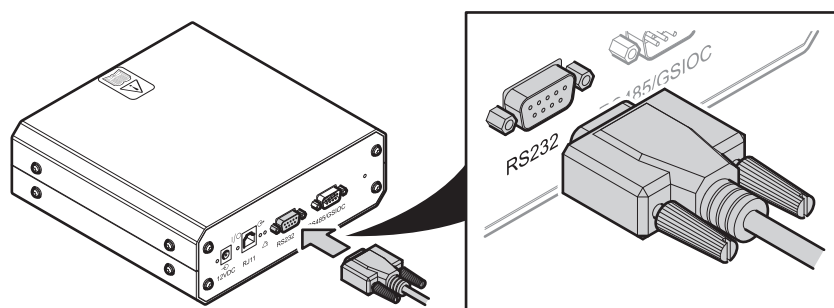

Connect the other end of the lead to the RS232, 10 pin output of the Integrity 10 unit.

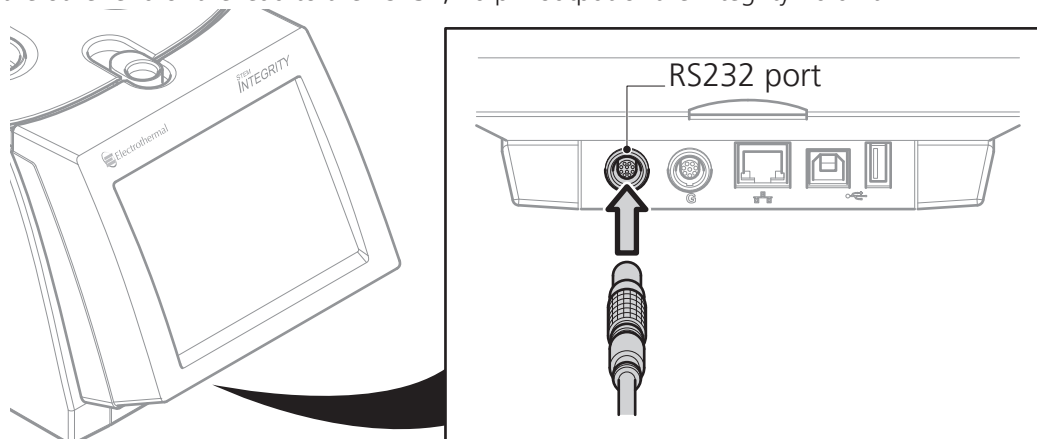

Using the power supply supplied with the Multi-Temp, plug in the jack plug to the 12 Volts DC in socket on the rear panel of the Multi-Temp. Connect the other end to a suitably rated A.C. mains power source.

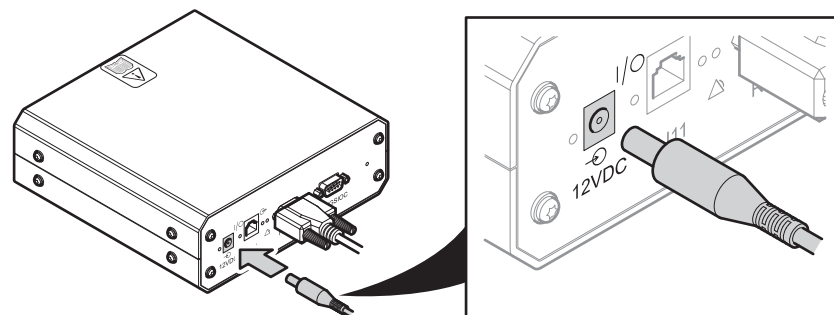

Fill the required glassware with solution and place it in the required cells. (If required use in conjunction with other Electrothermal accessories, e.g. the reflux unit, ATS20100).

Plug the thermocouples into the respective Multi-Temp front panel position that corresponds to the Integrity 10 cells to be used. Example use thermocouple plug position 1 for Integrity 10 cell position 1, thermocouple position 2 for Integrity 10 cell position 2 and so on.



Ensure you insert the thermocouples correctly. Failure to do so could result in damage to thermocouples and Multi-Temp.

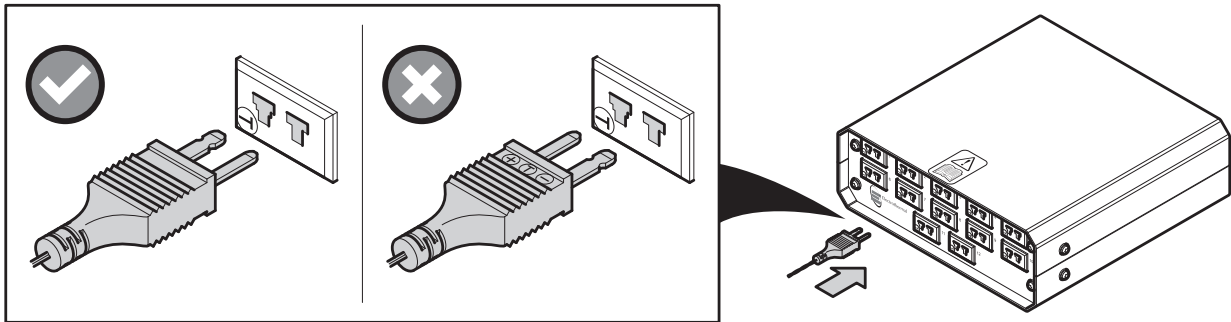

Place the probe tip ends of the thermocouples into the appropriate cell glassware ensuring the end of the thermocouple is placed well inside the solution.

### 7.17.2. Operating the Multi-Temp

Turn on the Integrity 10 unit and operate as previously described. Again the home screen will be seen after the warm up. **Note:** the thermometer symbol indicating connection.

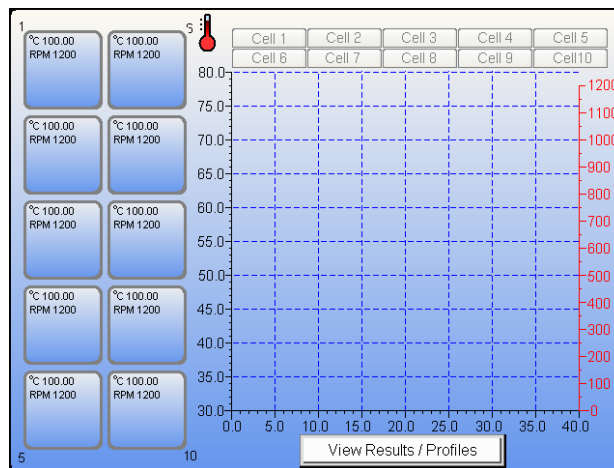

Press the cell button to select the cell for operation.

In the Manual or Profile control selection screen, touch the check box to confirm the use of 'control by content' using the Multi-Temp. **Note:** the check box only appears when a Multi-Temp is connected.

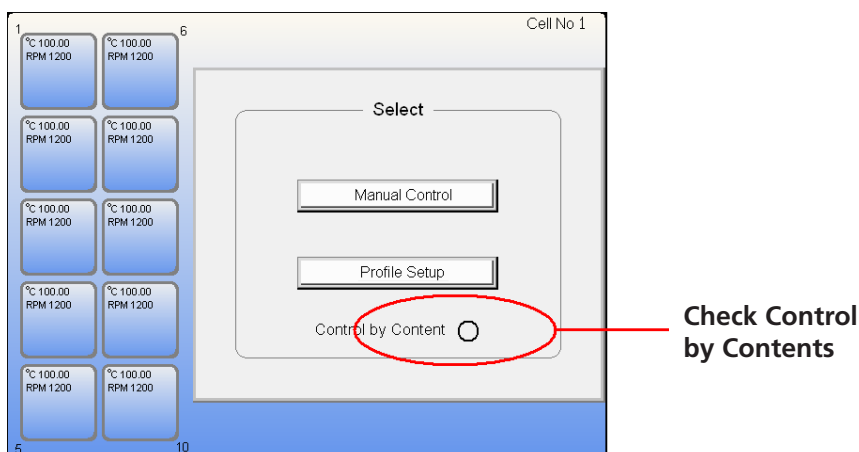

Select 'Manual Control' or 'Profile Setup' and input the setting as described previously.

**Observe:** The cell button of a 'Control by Contents' cell will also display the 'Multi-Temp present' Thermometer icon.



**NOTE:** The temperature value displayed in the cell button and shown on the graph is the measured temperature of the contents, NOT the block temperature.

## 7.18. External control – optional

### 7.18.1. PC control:

Connect the host PC to the Integrity 10 unit using the appropriate input socket as suited for the controlling application.

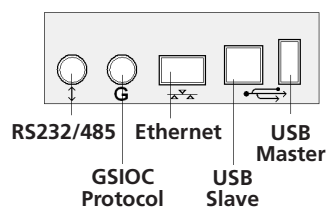

Open the Integrity software application (ATS11005) on the host PC (see M8162 instruction manual for Integrity software).

With all the services connected to the Integrity, turn on and wait for the home screen to appear.

A lock icon will appear on all the cell positions and you will not be able to use the touchscreen. You will only be able to control the Integrity 10 unit through the host PC and Integrity 10 software.

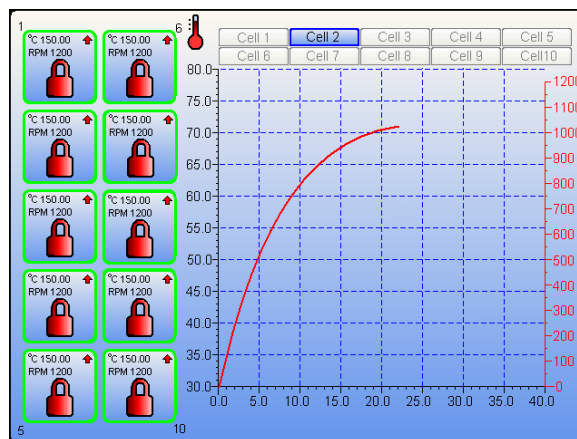

**Note:** You can't operate cells under external control using the Integrity 10 touch screen.

Upon completion of a run, turn off the Integrity 10 using the Power Supply I/O button as detailed in section 7.5.

## 8. Chemical resistance

It is recommended that any chemical spillages are cleaned up immediately.

Chemical	Side Panels / Front pod FRPS/ABS		Drip plate Polypropylene	
	20°C	60°C	20°C	60°C
Acetaldehyde	Major Effect	Major Effect	No data	No data
Acetic acid (10%)	Excellent Resistance	Major Effect	Excellent Resistance	Excellent Resistance
Acetic acid (glac./anh)	Major Effect	Major Effect	Excellent Resistance	Excellent Resistance
Acetic anhydride	Major Effect	Major Effect	No data	No data
Aceto-acetic ester	Major Effect	Major Effect	No data	No data
Acetone	Major Effect	Major Effect	Major Effect	Major Effect
Other Ketones	Major Effect	Major Effect	No data	No data
Acetonitrile	No data	No data	No data	No data
Acetylene	No data	No data	No data	No data
Acetyl salicylic Acid	Major Effect	Major Effect	No data	No data
Acid fumes	Major Effect	Major Effect	No data	No data
Acid salt	No data	No data	Excellent Resistance	Excellent Resistance
Alcohols	Major Effect	Major Effect	No data	No data
Aliphatic esters	Major Effect	Major Effect	No data	No data
Alkyl chlorides	Major Effect	Major Effect	No data	No data
Alum	Excellent Resistance	Excellent Resistance	No data	No data
Aluminium chloride	Excellent Resistance	Excellent Resistance	No data	No data
Aluminium sulphate	Excellent Resistance	Excellent Resistance	No data	No data
Ammonia anhydrous	Excellent Resistance	Major Effect	No data	No data
Ammonia, aqueous	Excellent Resistance	Major Effect	No data	No data
Ammonium chloride	Excellent Resistance	Excellent Resistance	No data	No data
Amyl acetate	Major Effect	Major Effect	No data	No data
Aniline	Major Effect	Major Effect	Excellent Resistance	Excellent Resistance
Antimony trichloride	Excellent Resistance	Excellent Resistance	No data	No data
Aqua ammonia	No data	No data	Excellent Resistance	Excellent Resistance
Aqua regia	Major Effect	Major Effect	No data	No data
Aromatic solvents	Major Effect	Major Effect	No data	No data
Ascorbic acid	Major Effect	Major Effect	No data	No data
Basic salt	Excellent Resistance	Excellent Resistance	Excellent Resistance	Excellent Resistance
Beer	Excellent Resistance	Excellent Resistance	No data	No data
Benzaldehyde	Excellent Resistance	No data	No data	No data
Benzene	Major Effect	Major Effect	No data	No data
Benzoic acid	Excellent Resistance	Excellent Resistance	Excellent Resistance	Excellent Resistance
Benzoyl peroxide	Excellent Resistance	No data	No data	No data
Boric acid	Excellent Resistance	Excellent Resistance	Excellent Resistance	Excellent Resistance
Brines, saturated	Excellent Resistance	Excellent Resistance	No data	No data



Chemical	Side Panels / Front pod FRPS/ABS		Drip plate Polypropylene	
	20 °C	60 °C	20 °C	60 °C
Bromine (K) solution	Excellent Resistance	Excellent Resistance	No data	No data
Bromine	Major Effect	Major Effect	No data	No data
Bromine liquid, tech	Major Effect	Major Effect	No data	No data
Bromine water, saturated aqueous	Major Effect	Major Effect	No data	No data
Butyl acetate	No data	No data	Excellent Resistance	Excellent Resistance
Calcium chloride	Excellent Resistance	Excellent Resistance	Excellent Resistance	Excellent Resistance
calcium hydroxide	No data	No data	No data	No data
Carbon dioxide	Excellent Resistance	Excellent Resistance	Excellent Resistance	Excellent Resistance
Carbon monoxide	Excellent Resistance	Excellent Resistance	Excellent Resistance	Excellent Resistance
Carbon disulphide	Major Effect	Major Effect	Major Effect	Major Effect
Carbonic acid	Excellent Resistance	Excellent Resistance	No data	No data
carbonic tetrachloride	Major Effect	Major Effect	Major Effect	Major Effect
Caustic soda & potash	Excellent Resistance	Excellent Resistance	Excellent Resistance	Excellent Resistance
Cellulose paint	No data	No data	No data	No data
Chlorhydric acid (10%)	No data	No data	Excellent Resistance	Excellent Resistance
Chlorhydric acid (37%)	No data	No data	Excellent Resistance	Major Effect
Chlorates of Na, K, Ba	Excellent Resistance	Excellent Resistance	No data	No data
Chlorine, dry	Excellent Resistance	Excellent Resistance	Excellent Resistance	Major Effect
Chlorine, wet	Excellent Resistance	Excellent Resistance	Excellent Resistance	Major Effect
Chloroacetic acid	Major Effect	Major Effect	No data	No data
Chlorobenzene	Major Effect	Major Effect	Major Effect	Major Effect
Chloroform	Major Effect	Major Effect	No data	No data
Chlorosulphic acid	Major Effect	Major Effect	No data	No data
Chromic acid (80%)	Excellent Resistance	Major Effect	Excellent Resistance	Excellent Resistance
Citric acid	Excellent Resistance	Excellent Resistance	Excellent Resistance	Excellent Resistance
Copper salts (most)	Excellent Resistance	Excellent Resistance	No data	No data
Cresylic acids (50%)	Major Effect	Major Effect	No data	No data
Cyclohexane	Major Effect	Major Effect	No data	No data
Detergents, synthetic	Excellent Resistance	Major Effect	No data	No data
Esters	Major Effect	Major Effect	No data	No data
Ether	Major Effect	Major Effect	No data	No data
Fatty acids (>C6)	Excellent Resistance	Excellent Resistance	No data	No data
Ferric chloride	Excellent Resistance	Excellent Resistance	No data	No data
Ferrous sulphate	Excellent Resistance	Excellent Resistance	No data	No data
Fluorinated refrigerants	Major Effect	Major Effect	No data	No data
Fluorine, dry	Major Effect	Major Effect	No data	No data
Fluorine, wet	Major Effect	Major Effect	No data	No data
Fluorosilicate acid	Major Effect	Major Effect	No data	No data

Chemical	Side Panels / Front pod FRPS/ABS		Drip plate Polypropylene	
	20 °C	60 °C	20 °C	60 °C
Formaldehyde (40%)	Excellent Resistance	Excellent Resistance	No data	No data
Formic acid	Excellent Resistance	Excellent Resistance	No data	No data
Fruit juice	Excellent Resistance	Excellent Resistance	No data	No data
Gelatin	Excellent Resistance	Excellent Resistance	No data	No data
Glycerin	Excellent Resistance	Excellent Resistance	No data	No data
Glycol, ethylene	Excellent Resistance	Excellent Resistance	No data	No data
Glycols	Major Effect	Major Effect	No data	No data
Glycolic acid	Major Effect	Major Effect	No data	No data
Hexamethylene diamine	No data	No data	No data	No data
Hexamine	Major Effect	Major Effect	No data	No data
Hydrazine	No data	No data	No data	No data
Hydrobromic acid (50%)	Excellent Resistance	Major Effect	Excellent Resistance	Major Effect
Hydrochloric acid (10%)	Excellent Resistance	Excellent Resistance	No data	No data
Hydrochloric acid (conc)	Excellent Resistance	Major Effect	No data	No data
Hydrocyanic acid	Excellent Resistance	Excellent Resistance	Excellent Resistance	Excellent Resistance
Hydrofluoric acid (40%)	Excellent Resistance	Major Effect	No data	No data
Hydrofluoric acid (75%)	Major Effect	Major Effect	No data	No data
Hydrogen peroxide (30-90%)	Excellent Resistance	Major Effect	No data	No data
Hydrogen sulphide	No data	No data	Excellent Resistance	Excellent Resistance
Hypochlorite's (Ma 12-14%)	Excellent Resistance	Major Effect	No data	No data
Iso-butyl-acetate	No data	No data	No data	No data
Lactic acid (90%)	Excellent Resistance	Excellent Resistance	No data	No data
Lead acetate	Excellent Resistance	Excellent Resistance	No data	No data
Lead perchlorate	No data	No data	No data	No data
Lime (CaO)	Excellent Resistance	Excellent Resistance	No data	No data
Maleic acid	Excellent Resistance	Excellent Resistance	Excellent Resistance	Excellent Resistance
Manganate, potassium (K)	Excellent Resistance	Excellent Resistance	No data	No data
Meat Juice	Excellent Resistance	Excellent Resistance	No data	No data
Mercuric chloride	Excellent Resistance	Major Effect	No data	No data
Mercury	Excellent Resistance	Excellent Resistance	No data	No data
Methanol	Major Effect	Major Effect	No data	No data
Methylene chloride	Major Effect	Major Effect	Major Effect	Major Effect
Milk products	Excellent Resistance	Major Effect	No data	No data
Moist air	Excellent Resistance	Excellent Resistance	No data	No data

Chemical	Side Panels / Front pod FRPS/ABS		Drip plate Polypropylene	
	20 °C	60 °C	20 °C	60 °C
Molasses	Excellent Resistance	Major Effect	No data	No data
Monoethanolamine	Major Effect	Major Effect	No data	No data
Naphtha	Excellent Resistance	Major Effect	No data	No data
Naphthalene	Major Effect	Major Effect	No data	No data
Neutral salt	Excellent Resistance	Excellent Resistance	Excellent Resistance	Excellent Resistance
Nickel salts	Excellent Resistance	Excellent Resistance	No data	No data
Nitrates of Na, K and NH <sub>3</sub>	Excellent Resistance	Excellent Resistance	No data	No data
Nitric acid (<25%)	Major Effect	Major Effect	Excellent Resistance	Major Effect
Nitric acid (<50%)	Major Effect	Major Effect	Major Effect	Major Effect
Nitric acid (<90%)	Major Effect	Major Effect	Major Effect	Major Effect
Nitric acid (fuming)	Major Effect	Major Effect	Major Effect	Major Effect
Nitrite (Na)	Excellent Resistance	Major Effect	No data	No data
Nitrobenzene	Major Effect	Major Effect	Major Effect	Major Effect
Oils, diesel	No data	No data	No data	No data
Oils, essential	Excellent Resistance	Excellent Resistance	No data	No data
Oils, lubricating + aromatic additives	Major Effect	Major Effect	No data	No data
Oils, mineral	Excellent Resistance	Excellent Resistance	No data	No data
Oils, vegetable and animal	Excellent Resistance	Excellent Resistance	No data	No data
Oleic acid	No data	No data	Excellent Resistance	Major Effect
Oxalic acid	Excellent Resistance	Major Effect	Excellent Resistance	Excellent Resistance
Ozone	Major Effect	Major Effect	No data	No data
Paraffin wax	Excellent Resistance	Excellent Resistance	No data	No data
Perchloric acid	No data	No data	Excellent Resistance	Excellent Resistance
Petroleum sprit	Major Effect	Major Effect	Major Effect	Major Effect
Phenol	Major Effect	Major Effect	Excellent Resistance	Excellent Resistance
Phosphoric acid (20%)	Excellent Resistance	Major Effect	Excellent Resistance	Excellent Resistance
Phosphoric acid (50%)	Excellent Resistance	Major Effect	Excellent Resistance	Excellent Resistance
Phosphoric acid (95%)	Excellent Resistance	Major Effect	Excellent Resistance	Excellent Resistance
Phosphorous chloride	No data	No data	No data	No data
Phosphorous pentoxide	No data	No data	No data	No data
Phthalic acid	No data	No data	Excellent Resistance	Excellent Resistance
Potassium bicarbonate	No data	No data	Excellent Resistance	Excellent Resistance
Potassium permanganate	No data	No data	Excellent Resistance	Excellent Resistance
Potassium hydroxide	No data	No data	Excellent Resistance	Excellent Resistance
Picric acid	No data	No data	No data	No data

Chemical	Side Panels / Front pod FRPS/ABS		Drip plate Polypropylene	
	20 °C	60 °C	20 °C	60 °C
Pyridine	Major Effect	Major Effect	No data	No data
salicylic aldehyder	Excellent Resistance	No data	No data	No data
Sea water	Excellent Resistance	Excellent Resistance	No data	No data
Silica acid	Excellent Resistance	Excellent Resistance	No data	No data
Silicon fluids	No data	No data	No data	No data
Silver nitrate	Excellent Resistance	Excellent Resistance	No data	No data
Sodium carbonate	Excellent Resistance	Excellent Resistance	No data	No data
Sodium cyanide	Excellent Resistance	Excellent Resistance	Excellent Resistance	Excellent Resistance
Sodium peroxide	Excellent Resistance	No data	No data	No data
Sodium silicate	Excellent Resistance	Major Effect	No data	No data
Sodium sulphide	Excellent Resistance	Major Effect	No data	No data
Stannic chloride	Major Effect	Major Effect	No data	No data
Starch	Excellent Resistance	Major Effect	No data	No data
Sugar, syrups & jams	Excellent Resistance	Excellent Resistance	No data	No data
Sulphamic acid	No data	No data	No data	No data
Sulphates (Na, K, Mg, Ca)	Excellent Resistance	Excellent Resistance	No data	No data
Sulphites	Excellent Resistance	Major Effect	No data	No data
Sulphonic acids	No data	No data	No data	No data
Sulphur	Excellent Resistance	No data	No data	No data
Sulphur dioxide, dry	Excellent Resistance	Major Effect	Excellent Resistance	Major Effect
Sulphur dioxide, wet	Excellent Resistance	Major Effect	Excellent Resistance	Major Effect
Sulphur dioxide, (96%)	Major Effect	Major Effect	No data	No data
Sulpher trioxide	Excellent Resistance	Excellent Resistance	No data	No data
Sulphuric acid (<50%)	Major Effect	Major Effect	Excellent Resistance	Excellent Resistance
Sulphuric acid (70%)	Major Effect	Major Effect	Excellent Resistance	Major Effect
Sulphuric acid (95%)	Major Effect	Major Effect	Major Effect	Major Effect
Sulphuric acid, fuming	Major Effect	Major Effect	No data	No data
Sulphur chlorides	No data	No data	No data	No data
Tallow	Excellent Resistance	Excellent Resistance	No data	No data
Tannic acid (10%)	No data	No data	Excellent Resistance	Excellent Resistance
Tartaric acid	Excellent Resistance	Excellent Resistance	Excellent Resistance	Excellent Resistance
Trichloroethylene	Major Effect	Major Effect	Major Effect	Major Effect
Urea (30%)	Excellent Resistance	Excellent Resistance	Excellent Resistance	Excellent Resistance
Vinegar	Excellent Resistance	Excellent Resistance	Excellent Resistance	Excellent Resistance

Chemical	Side Panels / Front pod FRPS/ABS		Drip plate Polypropylene	
	20°C	60°C	20°C	60°C
Vinegar	Excellent Resistance	Excellent Resistance	Excellent Resistance	Excellent Resistance
Water, distilled	Excellent Resistance	Excellent Resistance	Excellent Resistance	Excellent Resistance
Water, soft	Excellent Resistance	Excellent Resistance	Excellent Resistance	Excellent Resistance
Water, Hard	Excellent Resistance	Excellent Resistance	Excellent Resistance	Excellent Resistance
Wetting agents (<5%)	Excellent Resistance	Excellent Resistance	Excellent Resistance	Excellent Resistance
Yeast	Excellent Resistance	Major Effect	No data	No data
Zinc chloride	Major Effect	Major Effect	No data	No data

## 9. Reaction block dimensions

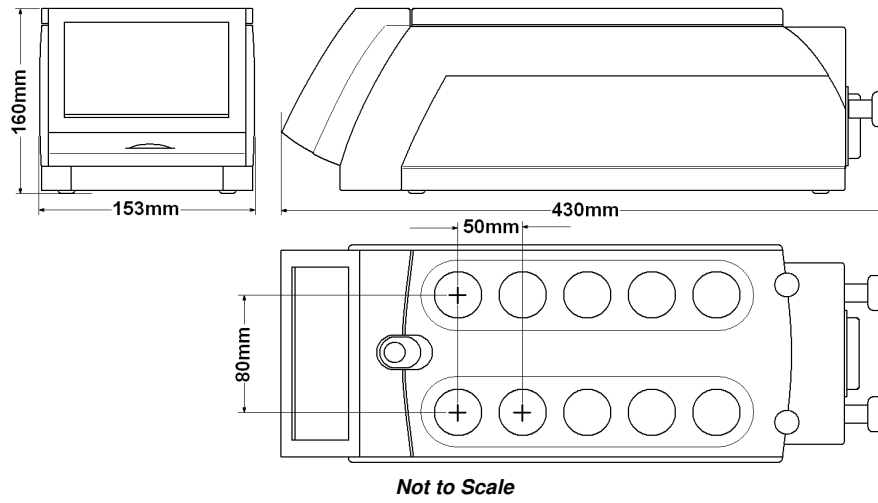

**Weight** 9.5 Kg  
**Location dimension (For use in robotic stations)**

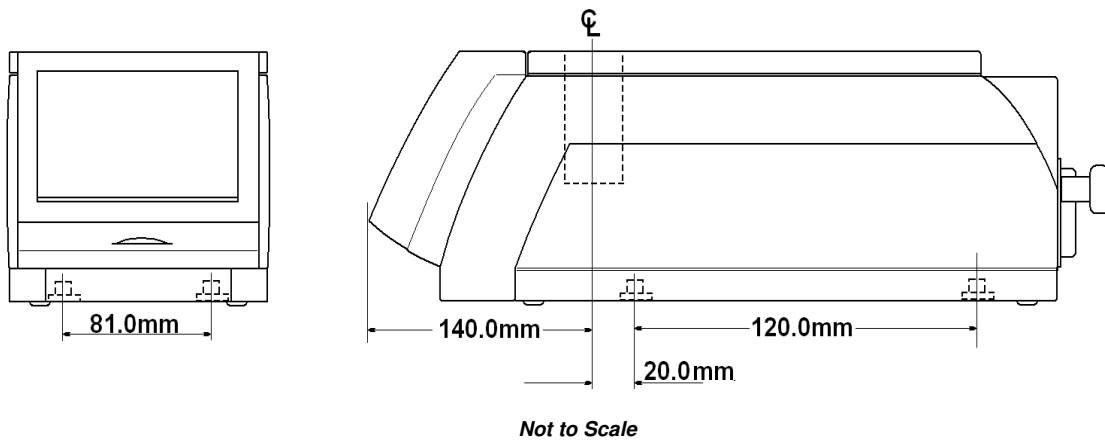

## 10. Power supply unit (PSU) specifications

Mains input supply voltage	100V - 230V a.c $\pm$ 10% at 50/60Hz
Power Consumption	Max 1500 watts
Mains cord and moulded IEC plug and lead set cable (UK) 16A BS1363	3 core earthed / ground. 2 meters long. Moulded IEC plug and Lead set – supply cord H05 V V- F – <b>Replace only with equivalent cable.</b>
Mains cord and moulded IEC plug and lead set cable Schuko (Europe)	3 core earthed / ground. 2 meters long. Moulded IEC plug and Lead set – supply cord H05 V V- F – <b>Replace only with equivalent cable.</b>
Mains cord and moulded IEC plug and lead set cable (USA)	3 core earthed / ground. 2 meters long. Moulded IEC plug and Lead set – supply cord SJT V W 1 - 105° – <b>Replace only with equivalent cable.</b>
Lead set plug and fuse (UK – Only)	13A BS1363

### Dimensions (PSU)

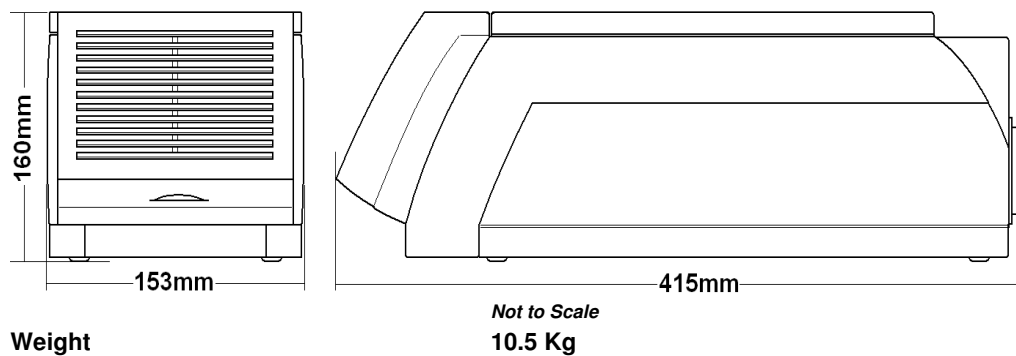

The Ingress Protection rating for the Integrity 10 Unit and power supply is IPX0.

# 11. Maintenance, service and repair

## 11.1. Maintenance



Unplug the unit from the mains voltage supply and allow it to cool before undertaking any maintenance tasks.



Maintenance should only be carried out by an approved Cole-Parmer representative. Failure to do so may result in damage to the product and in extreme cases be a danger to the end user.

With proper care in operation this equipment has been designed to give many years of reliable service. Contamination or general misuse will reduce the effective life of this product and may cause a hazard.

### Maintenance for the Integrity Unit and Power Supply should include:

- Periodic electrical safety testing (an annual test is recommended as the minimum for the PSU).

**AC** dielectric withstand (Flash / Hi Pot) **must not** be undertaken on this equipment as damage may result. Such testing will invalidate warranty.

**DC** dielectric withstand (flash / Hi Pot) may be applied to the **PSU only** (i.e. The Integrity 10 unit must not be connected when the PSU is being tested. The Integrity 10 unit operates at low voltage (15V DC) and must not be subjected to dielectric withstand (Flash / Hi Pot) testing.

**DC** dielectric withstand (flash / Hi Pot) testing shall only be undertaken by competent trained personnel using suitable test equipment / environment. DC test voltage should be no more than 1.414 times normal AC test value for a class I (grounded) equipment.

The test equipment / process should incorporate a discharge procedure to remove any stored DC charge that may remain on the PSU.

- **The Integrity PSU:** Routine cleaning of the equipment should be undertaken using a water moistened, clean cloth.
- **The Integrity Unit:** Side panels and drip tray may be cleaned using mild warm soapy water and must be wiped dry before use. Do not use anything abrasive on the Touch LCD screen. Before cleaning the touch LCD screen, ensure the unit is turned off and SD card removed. Clean the screen using PC screen wipes or a water dampened, clean non-abrasive cloth.



**DO NOT USE SOLVENTS OR ABRASIVE CHEMICALS FOR CLEANING ANY PART OF THIS EQUIPMENT.**



**ATTENTION. THERE ARE NO SERVICEABLE PARTS WITHIN THE INTEGRITY 10 POWER SUPPLY – IF IN DOUBT CONSULT MANUFACTURE OR SUPPLIER.**



**ENSURE THAT ANY CLEANING OR DECONTAMINATION AGENTS WILL NOT CAUSE A HAZARD AS A RESULT OF A REACTION WITH PARTS OF THE EQUIPMENT, OR RESIDUAL SUBSTANCES CONTAINED WITHIN.**



## 11.2. Spillage procedure

In case of solution spillage, turn off the Integrity 10 unit via the Power Supply On / Off switch. For light spillage wipe off the solution using a water dampened cloth and dry thoroughly before further use.

For spillage involving liquid solution spilt into a reaction well, turn off the Integrity 10 unit via the Power Supply On / Off switch. Turn off the chilled water supply and disconnect the supply hoses. Uncouple and remove any peripheral cables linked to a PC or accessories. Remove mains power input and mains connection cable.

Take the unit and tip any spillage (\*\*\*) out of the reaction cells, taking care to support the unit on the block. Do not place any undue pressure on the front pod as this may damage the unit and invalidate any warranty. Clean the unit using a water dampened cloth and dry thoroughly. **Ensure the unit is dry before further use. The Responsible Body shall check the electrical safety of the unit. If all safety requirements are met can the unit be used again. The above procedure is intended as a guide. Should spillage occur with a toxic or hazardous fluid then special precautions may be necessary.**

(\*\*\*) Observe special precautions for handling contaminated substances see Section 11.3 .

## 11.3. Decontamination



If the equipment has been exposed to toxic, radiological or biological contamination, the Responsible Body is responsible for carrying out appropriate decontamination. If hazardous material has been spilt on or inside the equipment, decontamination should only be undertaken under the control of the Responsible Body with due recognition of possible hazards. Before using any cleaning or decontamination method, the Responsible Body should check with the manufacturer that the proposed method will not damage the equipment.

## DECONTAMINATION CERTIFICATE

**NOTE:** In the event of any part of this unit becoming damaged, the damaged item(s) should be returned to the manufacturer for repair accompanied by a decontamination certificate. **Copies of the Certificate are available from Distributor/Manufacturer. At the end of life this product must be accompanied with a Decontamination Certificate.**

## 11.4. Servicing

Please contact your local Cole-Parmer Technical Sales Specialist or contact:

**E-mail:** cpservice@coleparmer.com

**Phone:** +44 (0)1785 810475

## 11.5. Error and warning messages

Error and warning messages will be displayed if the equipment status moves outside of the normal operating limits. The message will indicate recovery instructions or service support actions as appropriate.

Error and warning messages have been included to help the user determine the state of malfunction. In some instances the message will display a method for fault condition rectification.

When the warning symbol appears in a single cell button and the cell button turns red, touch the cell button to display the fault condition.

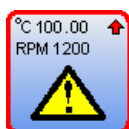

### 11.5.1. Heat exchanger over temperature error

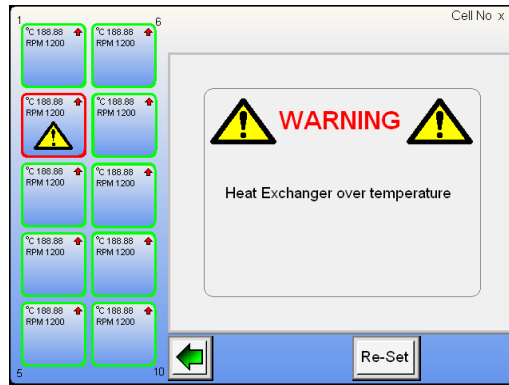

This warning shows a fault condition with cell number 2. Please contact the manufacturer or your distributor for service support.

If all the cells are affected another warning message will be displayed. A possible cause for this is a blocked flow chamber in the cell heat exchanger. Check water coolant supply for debris contamination.

To return to the home screen and view the performance of other operational cells touch the back button.

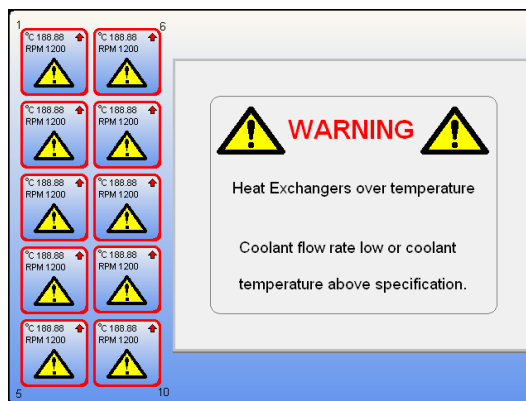

From this screen it can be seen that all cells heat exchangers are affected. This is caused by the coolant water flow rate being too low for the cells to operate or the coolant water temperature being too high (above 35°C).

If the problem is caused by lack of water flow rate the Integrity 10 will shut down to protect internal parts from damage. Once chilled water has been restored the unit will automatically recommence operation and the warning message screen will disappear.

If the problem is caused by the water temperature being too high the Integrity 10 will shut itself down as previously mentioned in order to protect internal parts from damage. Again when the correct temperature chilled water is restored the unit will recommence operation and the message screen disappears.

#### **Possible reasons for chilled water becoming too hot include but are not exclusive to:**

- Failed chiller unit.
- More than one appliance connected to the chiller system returning water at temperature greater than the chiller can cope with.
- Integrity 10 connected in series with another piece of equipment returning chilled water at a temperature above 35°C.
- Low coolant flow rate which is insufficient to remove the heat from the heat exchangers (less than 5/L per minute).

**Note:** - See Appendix 'A' Integrity cooling guide for the cooling specification.

### 11.5.2. Motor stall error

The illustrated screen shot shows a stir motor fault with cell position number 2. The cell position may still be used in heating / cooling mode but the cell will not stir. The cell will have to be replaced.

Contact the manufacturer as detailed in Section 12 customer support.

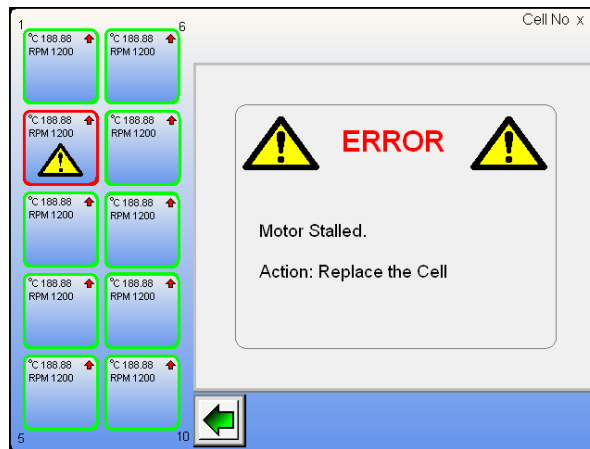

To return to the home screen and view the performance of other operational cells, touch the back button.



### 11.5.3. Cell failure error

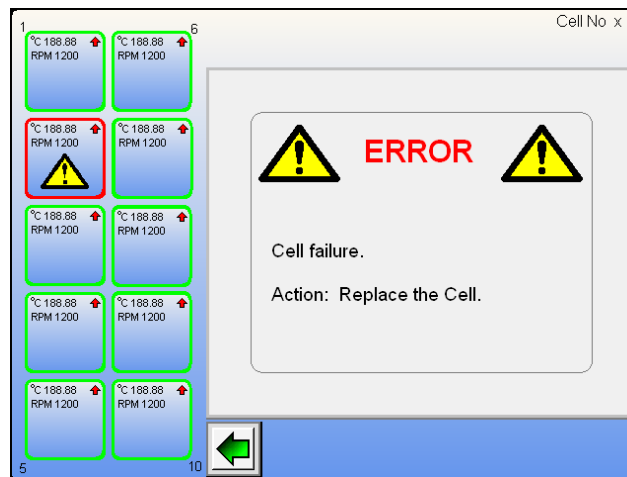

The illustrated screenshot shows a cell failure with cell position number 2. The cell will have to be replaced. Contact the manufacturer as detailed in Section 12 customer support.

To return to the home screen and view the performance of other operational cells touch the back button.



#### 11.5.4. Over voltage error

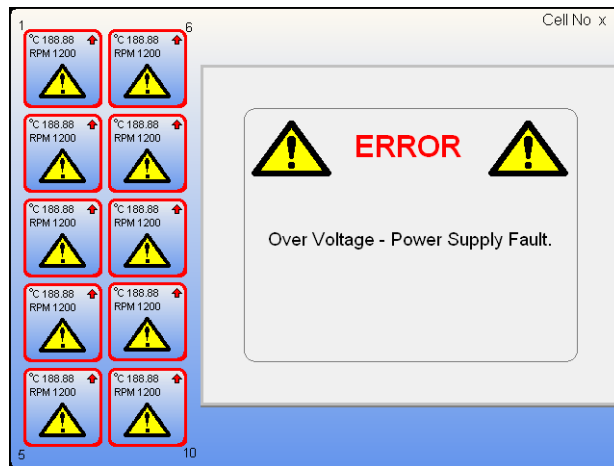

This indicates a fault with the Power Supply Unit. Contact the manufacturer as detailed in Section 12 customer support. Turn off the Integrity 10 and disconnect from the mains electricity supply.

#### 11.5.5. Under Voltage error

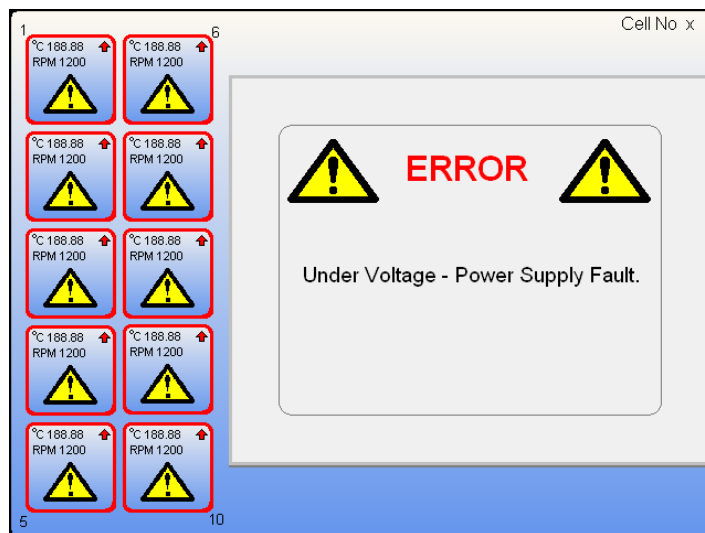

As above this indicates a fault with the Power Supply Unit. Contact the manufacturer as detailed in Section 12 customer support. Turn off the Integrity 10 and disconnect from the mains electricity supply.

### 11.5.6. Probe error

If an external probe is being used and it is either left out of the sample solution or drops out of the sample solution during a run, the following screen will appear if the probe is faulty.

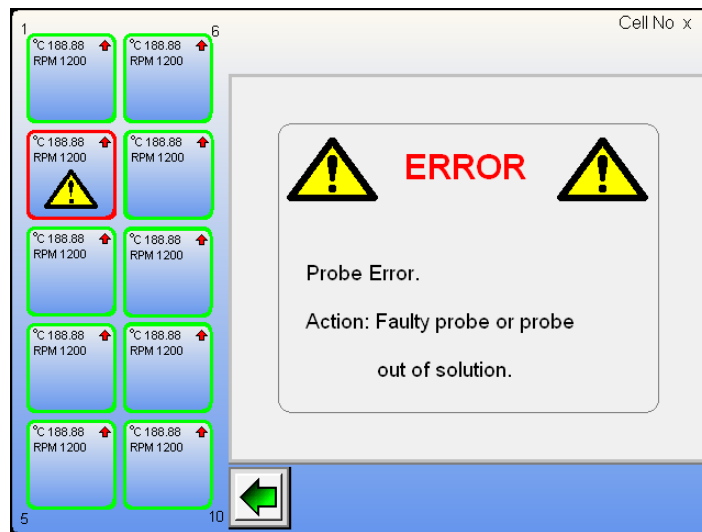

When the Integrity unit senses a block temperature that is 20°C above the solution temperature this error condition is created.

Once the fault has been rectified touch the cell button and select method of operation. e.g., manual or profile control and restart the cell.

To return to the home screen and view the performance of other operational cells touch the back button.



## 12. Customer support

If you require further technical or application assistance please contact:

**E-mail:** [cptechsupport@coleparmer.com](mailto:cptechsupport@coleparmer.com)

**Phone:** +44 (0)1785 810433

For servicing information please contact:

Service Department

Cole-Parmer Ltd

Beacon Road

Stone

Staffordshire

ST15 0SA

**E-mail:** [cpSERVICE@coleparmer.com](mailto:cpSERVICE@coleparmer.com)

**Phone:** +44 (0)1785 810475

We are continually striving to improve our products and software. If you have any comments or suggestions on how we can do things better please send them to us at:

**E-mail:** [enquiries@coleparmer.com](mailto:enquiries@coleparmer.com)

## 13. Spares and accessories

### SPARES

Please contact your local sales specialist or email [cpspares@coleparmer.com](mailto:cpspares@coleparmer.com) to enquire about available spares.

### ACCESSORIES

Order Number	Description	Quantity
ATS20100	Reflux / inerting block for integrity 10	1
ATS20002	Inerting caps, SVL22 thread for use with ATS20100, pack of 10	1
ATS10075	Glass tubes 24 / 150mm, SVL22 thread, pack of 10	1
ATS20003	Inerting caps, Kimble thread for use with ATS20100, pack of 10	1
ATS20004	Glass tubes 24 / 150mm, Kimble thread, pack of 10	1
ATS10001	Multi-Temp 12 plug in box	1
ATS10027	Temperature probes, pack of 6	1
ATS10027/10	Temperature probes, pack of 10	1
ATS10232E	Multi-IR 10 plug in unit	1
ATS10360/1	Non-intrusive IR sensor	1
ATS10230	Small intrusive IR probe in stainless steel PID-NIR5-BNSD	1
ATS10394/1	Hellma intrusive IR probe with high chemical resistance	1
ATS11005	Integrity PC software	1
AZS4206	Stirrer bars 10 / 6mm oval shaped for round bottomed tubes, pack of 10	1
AZS4235	Stirrer bars 12 / 4.5mm for flat bottomed tubes, pack of 10	1
ATS10055	Small volume test tubes 24 - 16mm taper (3ml), pack of 10	1
ATS10056	Reducing sleeves for ATS10055, pack of 10	1
ATS10101	Reducing sleeves 24 - 11mm, pack of 10	1
ATS10209	Micro-volume test tubes 24 - 11mm test tubes (1ml), pack of 10	1
M7438	Spare coolant supply hoses	2

Please visit [www.electrothermal.com](http://www.electrothermal.com) for a full list of available accessories.







## 15. Declaration of conformity



This product meets the applicable CE Directives and UKCA Legislation for radio frequency interference and may be expected not to interfere with, or be affected by, other equipment with similar qualifications. We cannot be sure that other equipment used in its vicinity will meet these standards and so we cannot guarantee

that interference will not occur in practise. Where there is a possibility that injury, damage or loss might occur if equipment malfunctions due to radio frequency interference, or for general advise before use, contact the manufacturer.

Declaration of Conformity is available to view online at [www.coleparmer.com](http://www.coleparmer.com)

### **EU Representative address**

Antylia Scientific GmbH  
Futtererstraße 16  
97877 Wertheim  
Deutschland  
Tel: +49 9377 9203-0  
Email: [sales@coleparmer.de](mailto:sales@coleparmer.de)

### **UK Representative address**

Antylia Scientific  
9 Orion Court  
Ambuscade Road  
Colmworth Business Park  
St. Neots  
PE19 8YX  
United Kingdom  
Tel: +44 (0) 1480 277339  
Email: [enquiries@antylia.com](mailto:enquiries@antylia.com)

# Cole-Parmer®



The Integrity 10 reaction station must be used with an appropriately rated cooling system at all times, even when the equipment is only used for heating applications.



Failure to use an appropriately rated cooling system will negatively impact the performance of the Integrity 10. In some circumstances this could reduce the life of the product, increase service frequency or cause permanent damage.



Damage caused to the Integrity 10 through the use of inappropriately rated cooling systems is not covered under warranty.



Damage caused to the Integrity 10 through the use of unfiltered or contaminated coolant is not covered under warranty.

### Integrity 10 Cooling Requirements

The Integrity 10 is capable of independently cooling each of its 10 cells down to a minimum temperature of -30°C, but this is only achievable when the product is coupled to a cooling system that can remove heat at a rate **greater or equal to** that collected by the Integrity.

It is important to understand the importance of this relationship and to select an appropriate cooling system so that you can achieve the performance needed for your application and get the results you expect.

### Understanding the systems relationship

Each of the Integrity's cells contain a cooling device (the TEC). While operating in cooling mode, these devices remove heat from the reaction vessel and pass it onto the cooling system via a heat exchanger. The temperature of the coolant increases which is then pumped out of the Integrity, where it's cooled by the chiller and rejected into the air.



It is important to note that even when a cell is heating and not using the cooling feature, a cooling system is *still* required to ensure damage is not sustained to the sensitive cells during operation.

- ☺ When appropriately matched, the cooling system and Integrity work in harmony and are able to achieve the performance expected.
- ☹ If inappropriately matched, the cooling system is unable to keep up with the demands placed upon it. In this situation, the cooling performance of the Integrity is negatively impacted reducing the rate of cooling and/or limiting the minimum temperature the cell is able to achieve.

In extreme circumstances i.e. when a cooling system is severely under-rated, the chillers reservoir of coolant will progressively increase in temperature until the cooling system displays an error message and potentially stops operation.

### Managing the load on the cooling system

Knowing how to manage the load placed upon your cooling system will help you achieve the performance you require and will also help you save energy.

There are three main factors which contribute to the load on the cooling system:

- The number of cells being cooled at any time.
- The cooling rate selected.
- The minimum temperature required.

#### Example 1

Cooling 10 cells in parallel places a higher load on the cooling system than only cooling 2 cells in parallel.

#### Example 2

Cooling at a rate of 5°C/minute places a higher load on the cooling system than cooling at 1°C/minute.

#### Example 3

Cooling down to a temperature of -30°C places a higher load on the cooling system than cooling down to a temperature of -10°C.

In a worst case scenario, an experiment would demand all 10 cells to cool to -30°C in parallel, using an uncontrolled ramping profile. Uncontrolled ramping is when a user hasn't specified a ramp-rate in the Integrity settings. In this situation, both the Integrity and cooler will need to work their hardest to reach the desired temperature.

The Integrity is easily capable of cooling all 10 cells down to a temperature of -30°C, provided it is coupled to an appropriately rated cooling system. The time taken to reach a temperature of -30°C using uncontrolled ramping is subjective and dependant on:

- The performance capabilities of the cooler.
- The ambient temperature in the laboratory.
- The contents of the vessel and its heat capacity (i.e. the amount of energy which must be removed from the contents in order to yield a measurable temperature change).
- The nature of the experiment being performed (e.g. exothermic reactions).

## Reducing the load on the cooling system

If you believe your system is struggling to meet the performance demands placed upon it, consider the following list of suggestions to help reduce the load on the system:

- Increase the temperature of the experiment.
- Reduce the number of cells which are cooling in parallel.
- Ensure your cooling system is regularly serviced and is maintained in line with the manufacturer's recommendations.
- Ensure the coolers condenser is clean and has unrestricted air-flow.
- Ensure coolant is clean with no contaminants which can block the Integrity heat exchangers.
- Reduce the cooling ramp-rate of the experiment.
- Reduce the ambient temperature of the laboratory using air conditioning.

A good indication that your cooling system is under-rated for your experiment is when you observe a temperature plateau when working below ambient temperatures.

For example: You set up the Integrity to cool all 10 cells down to a temperature of  $-20^{\circ}\text{C}$  however you noticed that the cells have only reached  $-15^{\circ}\text{C}$ . The cooler is struggling to meet the demands placed upon it because the rate at which heat is gathered by the Integrity now matches the capability of the cooler. (You may also observe an undulation in the minimum temperature as the coolers compressor cycles on and off in an attempt to maintain the coolants temperature.)

## Selecting a cooling system

Now that we've explained the relationship between the Integrity 10 and the cooling system, we shall discuss the important specifications of the cooling system.

There are four primary considerations when selecting a cooling system:

### 1 Working temperature range

The first parameter to consider when selecting your recirculating cooler is the working temperature range. In order for the Integrity to reach a minimum temperature of  $-30^{\circ}\text{C}$ , the cooler will need to be capable of working between  $5^{\circ}\text{C}$  and  $-5^{\circ}\text{C}$ .

The working temperature you use will be subjective to your experiment and is typically determined empirically. We recommend you start at  $5^{\circ}\text{C}$  and progressively reduce the coolers temperature until you achieve the performance required.

Tip: Don't set your chiller cooler than needed - it is always best practice to use the warmest working temperature possible which achieves your performance requirements to avoid unnecessary condensation and to avoid wasting energy.

### 2 Cooling Capacity

The cooling capacity is a characteristic which determines how quickly the cooler can remove the heat collected by the Integrity. As mentioned previously, the cooler needs a capacity **greater or equal** than that of the Integrity, so that the performance of the whole system can be comfortably maintained.

It is recommended that you select a product with a cooling capacity of at least 1.1KW (1100W) between the working temperature of range of 5 to  $-5^{\circ}\text{C}$ . With this cooling capacity, you will be able to use the Integrity 10 to its maximum potential.

Most manufacturers of recirculating coolers typically specify the cooling capacity of their equipment using a table, because there is a relationship between working temperature and cooling capacity of such systems.

For example, see the fictitious table below:

Working temperature (°C)	20	10	0	-10
Cooling Capacity (kW)	2.5	1.8	1	0.4

As you can see from this table, the cooling capacity decreases significantly as the working temperature is reduced.

It should be noted that manufacturers of recirculating coolers would advertise this system as a *nominal* 2.5kW system. This is in fact the cooling capacity at 20°C only. You should always determine the cooling capacity over the recommended working temperature range of the Integrity.

It's possible to run the Integrity using a lower rated cooling capacity, although this isn't recommended. Please see the next section on 'lower rated systems' for more information about this.

### 3 Flow Rate

The cooler should be capable of providing coolant at a rate of at least 5 Litres per minute, *directly* into the Integrity.

If you are sharing your cooling system with other equipment or accessories, you must ensure that the supply of 5 Litres per minute is maintained for the duration of your work.

Do not compromise the flow rate of the coolant into the Integrity by using incorrectly specified ancillary items such as couplers, reducers or tee-pieces, for example.

### 4 Pressure

In order to obtain the flow rate discussed above, the coolers pump must be capable of providing a pressure of at least 2 bar.

If you are sharing your cooling system with other equipment or accessories, you must ensure that the pressure of at least 2 bar is maintained for the duration of your work.

### Lower rated systems

It is not recommended that you use the Integrity with a lower rated system than explained above. If you do, you will not necessarily be able to reach the performance characteristics required by your work nor will you be able to exploit the full potential of the Integrity 10 and cool all cells down to a minimum temperature of -30°C

### Filtering requirements

When coupling your Integrity 10 to a cooling system it is required that you also fit a 50 micron inline filter (if one is not present in the cooler) to prevent the ingress of contaminants into the cell heat exchangers. The filter should be installed on the outlet of the chiller.

Partial restriction or blockage of heat exchangers caused by contaminants will impact the system performance and potentially void your warranty.

### Summary of cooling system specification

Working temperature range	5 to -5°C
Cooling Capacity	1.1kW (1100W) between 5°C to -5°C
Flow Rate	≥ 5 Litres per minutes
Pressure	≥ 2 bar
Inline Filter	50 micron

*Table 1 - Recommended specification of Integrity 10 cooling system*

### Circulating Fluids

Once you have selected your cooling system, you will need to follow the manufacturer's recommendation and use a fluid suitable for your application. Manufacturers will recommend avoiding anti-freeze intended for cars, instead prompting use of fluids designed specifically for lab equipment.

When working with refrigerated and other cooling equipment, it is important to use a fluid that will not freeze because the temperature inside the cooling equipment may be significantly colder than the set temperature.

#### Circulating Fluids – Cooling

Water-based synthetic fluids are popular choices for cooling. They can be used across a broad temperature range, especially when used in sealed or vacuum systems. Glycols, when mixed with water, become antifreeze. This does not mean that you can buy and use automotive antifreeze. What's good for your car is not necessarily good for your lab equipment. There are two glycols which are commonly used: Ethylene glycol (EG) and propylene glycol (PG). Of the two, EG has slightly better thermal properties and can cool in a broader temperature range. However, it is highly toxic and not usable in all applications. In those cases, PG is a good alternative. We recommend mixing with distilled water; the best mix rate is 50/50.

#### Circulating Fluids – Mixes

Mixes are offered as a convenience and are made up of one or more of the fluids, described above, like a mix of ethylene glycol, water and algaecide. They are usually sold in volumes that make sense for filling common-sized equipment like chillers.

# Ordering Information

Order No.	Series	Model
36630-00	Integrity 10	PS20000

Warranty Registration



**Cole-Parmer®**  
essentials

**Antylia Scientific Ltd.**  
Beacon Road,  
Stone,  
Staffordshire,  
ST15 0SA,  
United Kingdom

**UK**

T: +44 (0) 1480 272279  
E: uk.sales@antylia.com  
W: coleparmer.co.uk

**India**

T: +9122 61394444  
E: info@coleparmer.in  
W: coleparmer.in

**Germany**

T: +49 (0) 9377 92030  
E: de.sales@antylia.com  
W: coleparmer.de

**China**

T: +1 847 549 7600  
E: sales@antylia.com  
W: coleparmer.com

**France**

T: +33 (0) 1486 37800  
E: fr.sales@antylia.com  
W: coleparmer.fr

**USA**

T: +1 847 549 7600  
E: sales@antylia.com  
W: coleparmer.com

**Italy**

T: +39 (0) 284349215  
E: it.sales@antylia.com  
W: coleparmer.it

**Canada**

T: +514 355 6100  
E: info@antylia.ca  
W: coleparmer.ca

**Other**

T: +1 847 549 7600

