

Register your instrument!
www.eppendorf.com/myeppendorf



Centrifuge 5425 R

Original instructions

Copyright ©2019 All rights reserved, including graphics and images. No part of this publication may be reproduced without the prior permission of the copyright owner.

Microtainer® is a registered trademark of Becton Dickinson, USA.

Eppendorf® and the Eppendorf Brand Design are registered trademarks of Eppendorf AG, Germany.

Eppendorf VisioNize® is a registered trademark of Eppendorf AG, Germany.

Registered trademarks and protected trademarks are not marked in all cases with ® or ™ in this manual.

U.S. Patents are listed on www.eppendorf.com/ip

Table of contents

1	Operating instructions	7
1.1	Using this manual	7
1.2	Danger symbols and danger levels	7
1.2.1	Danger symbols	7
1.2.2	Danger levels	7
1.3	Symbols used	8
1.4	Abbreviations used	8
2	Safety	9
2.1	Intended use	9
2.2	User profile	9
2.3	Information on product liability	9
2.4	Application limits	10
2.4.1	Declaration concerning the ATEX directive (2014/34/EU)	10
2.5	Warnings for intended use	10
2.5.1	Personal injury or damage to device	10
2.5.2	Incorrect handling of the centrifuge	12
2.5.3	Incorrect handling of the rotors	12
2.5.4	Extreme strain on the centrifugation tubes	13
2.6	Safety instructions on the device	15
3	Product description	17
3.1	Product overview	17
3.2	Delivery package	18
3.3	Features	18
3.4	Name plate	19
4	Installation	21
4.1	Selecting the location	21
4.2	Preparing installation	22
4.3	Installing the instrument	22
5	Operation	25
5.1	Operating controls	25
5.2	Navigating in the menu	27
5.3	Menu structure	27
5.4	Preparing for centrifugation	28
5.4.1	Switching on the centrifuge	28
5.4.2	Removing the rotor	28
5.4.3	Inserting the rotor	28
5.4.4	Triggering rotor detection	29
5.4.5	Loading the rotor	29
5.4.6	Closing the centrifuge lid	31
5.4.7	Closing the QuickLock rotor lid	32

Table of contentsCentrifuge 5425 R
English (EN)

5.5	Cooling	32
5.5.1	Temperature adjustment	32
5.5.2	Temperature display	32
5.5.3	Temperature monitoring	33
5.5.4	FastTemp	33
5.5.5	Continuous cooling	34
5.6	Centrifugation	34
5.6.1	Centrifuging with time setting	35
5.6.2	Centrifuging in continuous operation	35
5.6.3	Short run centrifugation	36
5.7	Aerosol-tight centrifugation	37
5.7.1	Aerosol-tight centrifugation in a fixed-angle rotor	37
6	Maintenance	39
6.1	Service	39
6.2	Preparing cleaning/disinfection	39
6.3	Cleaning/disinfection	40
6.3.1	Cleaning and disinfecting the device	41
6.3.2	Cleaning and disinfecting the rotor	42
6.3.3	Cleaning and disinfecting the rotor lid	42
6.4	Additional care instructions for refrigerated centrifuges	43
6.5	Cleaning glass breakage	43
6.6	Fuses	44
6.7	Decontamination before shipment	44
7	Troubleshooting	45
7.1	General errors	45
7.2	Error messages	46
7.3	Emergency release	47
8	Transport, storage and disposal	49
8.1	Transport	49
8.2	Storage	49
8.3	Disposal	50
9	Technical data	51
9.1	Power supply	51
9.2	Ambient conditions	51
9.3	Weight/dimensions	51
9.4	Noise level	52
9.5	Application parameters	52
9.6	Service life of accessories	53
10	Rotors for the Centrifuge 5425 R	55
10.1	Rotor FA-24x2 and rotor FA-24x2-PTFE	56
10.2	Rotor FA-18x2 kit	57
10.3	Rotor FA-10x5	58
10.4	Rotor F-32x0.2-PCR	59
10.5	Rotor S-96x0.2	60

11 Ordering information	61
Certificates	63

1 Operating instructions







1.1 Using this manual

- ▶ Read this operating manual completely before using the device for the first time. Observe the instructions for use of the accessories where applicable.
- ▶ This operating manual is part of the product. Please keep it in a place that is easily accessible.
- ▶ Enclose this operating manual when transferring the device to third parties.
- ▶ The current version of the operating manual for all available languages can be found on our webpage www.eppendorf.com/manuals.

1.2 Danger symbols and danger levels

1.2.1 Danger symbols

The safety instructions in this manual have the following danger symbols and danger levels:

	Hazard point		Biohazard
	Electric shock		Risk of crushing
	Material damage		Explosive substances

1.2.2 Danger levels

DANGER	<i>Will</i> lead to severe injuries or death.
WARNING	<i>May</i> lead to severe injuries or death.
CAUTION	May lead to light to moderate injuries.
NOTICE	May lead to material damage.

Operating instructions

Centrifuge 5425 R
English (EN)

1.3 Symbols used

Depiction	Meaning
1. 2.	Actions in the specified order
▶	Actions without a specified order
•	List
<i>Text</i>	Display or software texts
i	Additional information

1.4 Abbreviations used**PCR**

Polymerase Chain Reaction

PTFE

Polytetrafluorethylene

rcf

Relative centrifugal force : g -force in m/s^2

rpm

Revolutions per minute

UV

Ultraviolet radiation

2 Safety

2.1 Intended use

The Centrifuge 5425 R is used for the separation of aqueous solutions and suspensions of different densities in approved sample tubes.

The Centrifuge 5425 R is exclusively intended for use indoors. All country-specific safety requirements for operating electrical equipment in the laboratory must be observed.

2.2 User profile

The device and accessories may only be operated by trained and skilled personnel.

Before using the device, read the operating manual and the instructions for use of the accessories carefully and familiarize yourself with the device's mode of operation.

2.3 Information on product liability

In the following cases, the designated protection of the device may be affected. The liability for any resulting damage or personal injury is then transferred to the owner:

- The device is not used in accordance with the operating manual.
- The device is used outside of its intended use.
- The device is used with accessories or consumables that are not recommended by Eppendorf.
- The device is maintained or repaired by persons not authorized by Eppendorf AG.
- The user makes unauthorized changes to the device.

2.4 Application limits

2.4.1 Declaration concerning the ATEX directive (2014/34/EU)



DANGER! Risk of explosion.

- ▶ Do not operate the device in areas where explosive substances are handled.
- ▶ Do not use this device to process any explosive or highly reactive substances.
- ▶ Do not use this device to process any substances which may generate an explosive atmosphere.

Due to its design and the environmental conditions inside the device, the Centrifuge 5425 R is not suitable for use in a potentially explosive atmosphere.

The device must be used only in a safe environment, such as in the open environment of a ventilated laboratory or a fume hood. The use of substances which could create a potentially explosive atmosphere is not permitted. The final decision on the risks associated with the use of these types of substances is the responsibility of the user.

2.5 Warnings for intended use

2.5.1 Personal injury or damage to device



WARNING! Electric shock due to damage to the device or mains/power cord.

- ▶ Only switch on the device if the device and mains/power cord are undamaged.
- ▶ Only operate devices which have been installed or repaired properly.
- ▶ In case of danger, disconnect the device from the mains/power supply voltage. Disconnect the mains/power plug from the device or the earth/grounded socket. Use the isolating device intended for this purpose (e.g. the emergency switch in the laboratory).



WARNING! Lethal voltages inside the device.

If you touch any parts which are under high voltage you may experience an electric shock. Electric shocks cause injuries to the heart and respiratory paralysis.

- ▶ Ensure that the housing is closed and undamaged.
- ▶ Do not remove the housing.
- ▶ Ensure that no liquids can penetrate the device.

Only authorized service staff may open the device.



WARNING! Danger due to incorrect voltage supply.

- ▶ Only connect the device to voltage sources which correspond with the electrical requirements on the name plate.
- ▶ Only use earth/grounded sockets with a protective earth (PE) conductor.
- ▶ Only use the mains/power cord supplied.



WARNING! Damage to health due to infectious liquids and pathogenic germs.

- ▶ When handling infectious liquids and pathogenic germs, observe the national regulations, the biosafety level of your laboratory, the material safety data sheets, and the manufacturer's application notes.
- ▶ Wear your personal protective equipment.
- ▶ For comprehensive regulations about handling germs or biological material of risk group II or higher, please refer to the "Laboratory Biosafety Manual" (source: World Health Organization, Laboratory Biosafety Manual, the current edition).



WARNING! Risk of injury when opening or closing the centrifuge lid

There is a risk of crushing your fingers when opening or closing the centrifuge lid.

- ▶ Do not reach between the device and centrifuge lid when opening or closing the centrifuge lid.
- ▶ Do not reach into the locking mechanism of the centrifuge lid.
- ▶ Open the centrifuge lid fully to ensure that the centrifuge lid cannot slam shut.



WARNING! Risk of injury from rotating rotor.

If the emergency release of the lid is activated, the rotor may continue to rotate for several minutes.

- ▶ Wait for the rotor to stop before activating the emergency release.
- ▶ To check, look through the monitoring glass in the centrifuge lid.



WARNING! Risk of injury from chemically or mechanically damaged accessories.

Even minor scratches and cracks can lead to severe internal material damage.

- ▶ Protect all accessory parts from mechanical damage.
- ▶ Inspect the accessories for damage before each use. Replace any damaged accessories.
- ▶ Do not use accessories that have exceeded their maximum service life.



CAUTION! Poor safety due to incorrect accessories and spare parts.

The use of accessories and spare parts other than those recommended by Eppendorf may impair the safety, functioning and precision of the device. Eppendorf cannot be held liable or accept any liability for damage resulting from the use of accessories and spare parts other than those recommended, or from the improper use of such equipment.

- ▶ Only use accessories and original spare parts recommended by Eppendorf.

**NOTICE! Damage to the device due to spilled liquids.**

1. Switch off the device.
2. Disconnect the device from the mains/power supply.
3. Carefully clean the device and the accessories in accordance with the cleaning and disinfection instructions in the operating manual.
4. If a different cleaning and disinfecting method is to be used, contact Eppendorf AG to ensure that the intended method will not damage the device.

**NOTICE! Damage to electronic components due to condensation.**

Condensate may form in the device when it has been transported from a cool environment to a warmer environment.

- ▶ After installing the device, wait for at least 4 h. Only then connect the device to the mains/power line.

2.5.2 Incorrect handling of the centrifuge

**NOTICE! Damage from knocking against or moving the device during operation.**

If the rotor hits against the rotor chamber wall, this will cause considerable damage to the device and rotor.

- ▶ Do not move or knock against the device during operation.

2.5.3 Incorrect handling of the rotors

**WARNING! Risk of injury from improperly attached rotors and rotor lids.**

- ▶ Only centrifuge with the rotor and rotor lid firmly tightened.
- ▶ If unusual noises occur when the centrifuge starts, the rotor or the rotor lid may not be attached properly. Stop the centrifugation immediately.

**CAUTION! Risk of injury due to asymmetric loading of a rotor.**

- ▶ Always load all positions of a swing-bucket rotor with buckets.
- ▶ Load buckets symmetrically with identical tubes or plates.
- ▶ Only load adapters with suitable tubes or plates.
- ▶ Always use tubes or plates of the same type (weight, material/density and volume).
- ▶ Check that loading is symmetrical by balancing the adapters and tubes or plates used with a balance.



CAUTION! Risk of injury from overloaded rotor.

The centrifuge is designed for the centrifugation of material with a maximum density of 1.2 g/mL at maximum speed and filling volume and/or load.

- ▶ Do not exceed the maximum load of the rotor.



NOTICE! Damage to rotors from aggressive chemicals.

Rotors are high-quality components which withstand extreme stresses. This stability can be impaired by aggressive chemicals.

- ▶ Avoid using aggressive chemicals such as strong and weak alkalis, strong acids, solutions with mercury ions, copper ions and other heavy metal ions, halogenated hydrocarbons, concentrated saline solutions and phenol.
- ▶ If it is contaminated by aggressive chemicals, clean the rotor and especially the rotor bores immediately using a neutral cleaning agent.
- ▶ Due to the manufacturing process, color variations may occur on PTFE coated rotors. These color variations do not affect the service life or resistance to chemicals.

2.5.4 Extreme strain on the centrifugation tubes



CAUTION! Risk of injury from overloaded tubes.

- ▶ Note the loading limits specified by the tube manufacturer.
- ▶ Only use tubes which are approved by the manufacturer for the required *g*-forces (rcf).



NOTICE! Risk from damaged tubes.

Damaged tubes must not be used as this could cause further damage to the device and the accessories and loss of the samples.

- ▶ Visually check all tubes for damage before use.



NOTICE! Danger due to open tube lids.

Open tube lids may break off during centrifugation and damage both the rotor and the centrifuge.

- ▶ Carefully seal all tube lids before centrifuging.
Exception: Observe the information on the centrifugation of spin columns in the FA-18x2-KIT rotor.



NOTICE! Damage to plastic tubes due to organic solvents.

When using organic solvents (e.g., phenol, chloroform), the strength of plastic tubes may be reduced and the tubes may become damaged.

- ▶ Observe the manufacturer's information on the chemical resistance of the tubes.

Safety

Centrifuge 5425 R
English (EN)







NOTICE! Danger due to deformed or brittle tubes. Autoclaving at excessive temperatures can lead to plastic tubes becoming brittle and deformed.

This could cause damage to the device and the accessories and sample loss.

- ▶ Observe the temperatures specified by the manufacturer when autoclaving tubes.
 - ▶ Do not use deformed or brittle tubes.
-

2.6 Safety instructions on the device

Symbol	Meaning	Location
	NOTICE ▶ Observe the safety instructions in the operating manual.	Right side of the device.
	▶ Observe the operating manual.	
	▶ Warning: Possible hand injury.	Upper side of the device, under the centrifuge lid.
	CAUTION ▶ Always tighten the rotor with the enclosed rotor key.	Upper side of the device, under the centrifuge lid.
	Warning of biological risks when handling infectious liquids or pathogenic germs.	Aerosol-tight fixed-angle rotors: rotor lid

Safety

Centrifuge 5425 R
English (EN)

3 Product description

3.1 Product overview

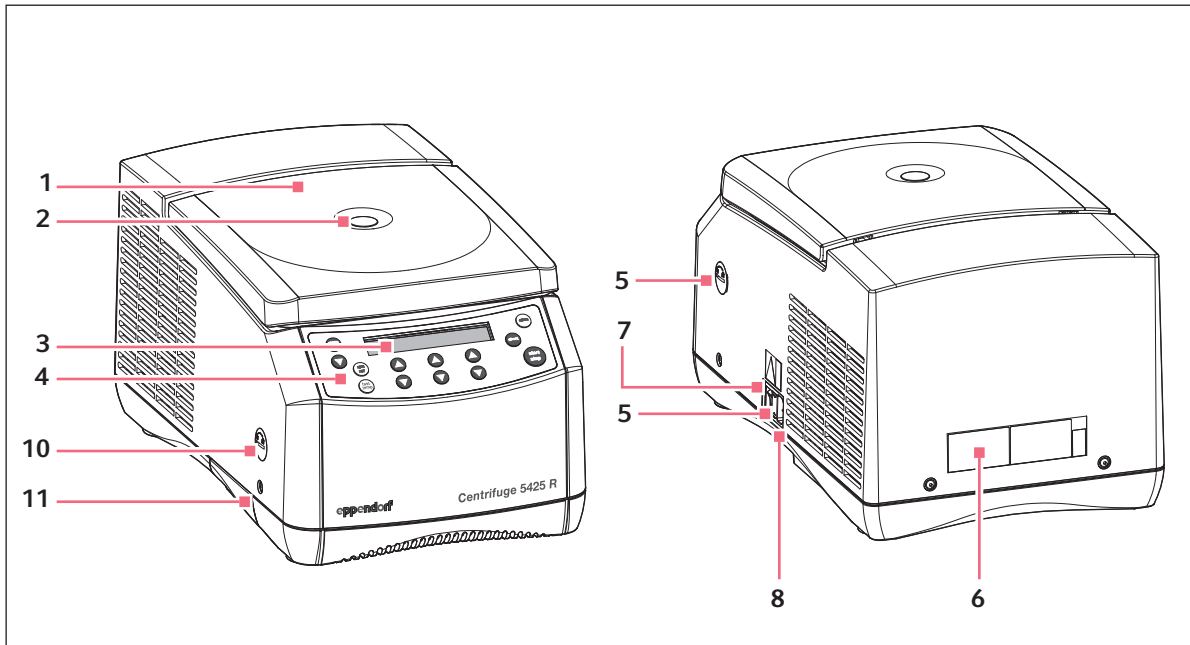

Fig. 3-1: Front and rear view of the Centrifuge 5425 R

- | | |
|--|--|
| 1 Centrifuge lid | 7 Mains/power switch
Switch for switching the centrifuge on and off. |
| 2 Monitoring glass
Visual control for rotor stop or speed control option using stroboscope | 8 Mains/power connection
Connection socket for the mains cable supplied. |
| 3 Display | 9 Fuse holder |
| 4 Control panel
Keys and dials (dependent on the device version) for operating the centrifuge. | 10 Interface for software updates
Only for authorized service personnel |
| 5 Emergency release | 11 Condensation water tray |
| 6 Name plate | |

Product description

Centrifuge 5425 R
English (EN)

3.2 Delivery package

1	Centrifuge 5425 R
1	Rotor key
1	Mains/power cord
1	Fuse
1	Instructions
1	Condensation water tray



- ▶ Check whether the delivery is complete.
- ▶ Check all parts for any transport damage.
- ▶ To safely transport and store the device, retain the transport box and packing material.

3.3 Features

The versatile Centrifuge 5425 R has a maximum capacity of 10 x 5 mL and reaches a maximum speed of 21,300 x g / 15,060 rpm. You can choose from six different rotors to centrifuge the following tubes for your various applications:

- Micro test tubes (0.2 to 5.0 mL)
- PCR strips
- Microtainers (0.6 mL)
- Spin columns (1.5/2.0 mL)
- Cryogenic tubes

The Centrifuge 5425 R has an additional temperature control function for centrifugation between -10 °C and +40 °C. The **fast temp** function is used to start a temperature control run without samples in order to quickly bring the rotor chamber to the set temperature.

The Centrifuge 5425 R can be connected to the Eppendorf VisioNize system. The Eppendorf VisioNize system provides the option to connect the centrifuge to centralized monitoring and data management software. For more information, please visit www.eppendorf.com.

3.4 Name plate

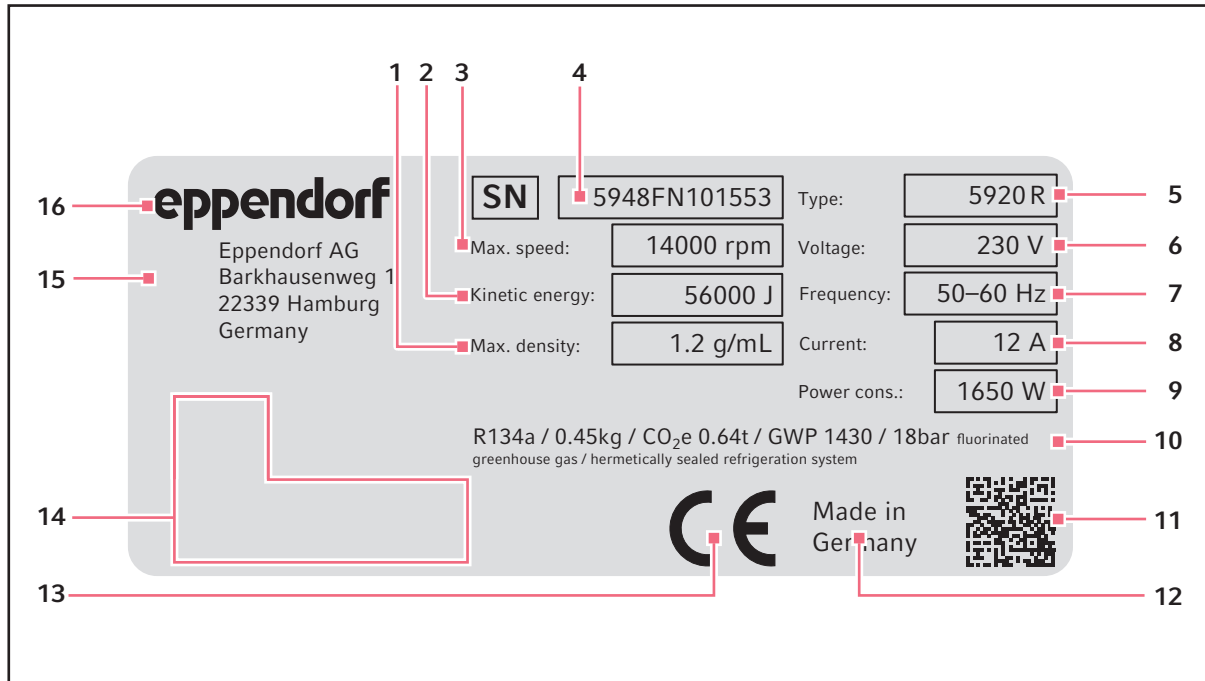







Fig. 3-2: Eppendorf AG device identification (example)

- | | |
|--|---|
| 1 Maximum density of the material for centrifuging | 9 Maximum rated power |
| 2 Maximum kinetic energy | 10 Information on the refrigerant (refrigerated centrifuges only) |
| 3 Maximum speed | 11 Data matrix code for serial number |
| 4 Serial number | 12 Designation of origin |
| 5 Product name | 13 CE marking |
| 6 Rated voltage | 14 Certification marks and symbols (device-specific) |
| 7 Rated frequency | 15 Manufacturer's address |
| 8 Maximum rated current | 16 Manufacturer |

Product description

Centrifuge 5425 R
English (EN)

Tab. 3-1: Certification and conformity marks and symbols (device-specific)

Symbol/sign	Meaning
	Serial number
	Mark for waste electrical and electronic equipment in accordance with the EN 50419 standard in accordance with directive 2012/19/EU (WEEE) of the European Union
	UL listing certification mark: Representative samples of the device have been tested by Underwriters Laboratories (UL) in accordance with the applicable safety standards for the USA and Canada
	FCC mark of conformity; electromagnetic compatibility tested in accordance with <i>Federal Communications Commission</i> (FCC, USA) regulations
	RoHS mark in accordance with standard SJ/T 11364, <i>Marking for the restriction of the use of hazardous substances in electrical and electronic products</i> , People's Republic of China
	Conformity with the relevant directives for the Eurasian Economic Union

4 Installation

4.1 Selecting the location



WARNING! Danger due to incorrect voltage supply.

- ▶ Only connect the device to voltage sources which correspond with the electrical requirements on the name plate.
 - ▶ Only use earth/grounded sockets with a protective earth (PE) conductor.
 - ▶ Only use the mains/power cord supplied.
-



NOTICE! If an error occurs, objects in the immediate vicinity of the device may become damaged.

- ▶ In accordance with the recommendations of EN 61010-2-020, leave a safety clearance of **30 cm** around the device during operation.
- ▶ Please remove all materials and objects from this area.



NOTICE! Damage due to overheating.

- ▶ Do not install the device near heat sources (e.g. heating, drying cabinet).
- ▶ Do not expose the device to direct sunlight.
- ▶ Ensure unobstructed air circulation. Maintain a clearance of at least 30 cm around all ventilation gaps.



NOTICE! Radio interference.

For devices with Class A noise emission in accordance with EN 61326-1/EN 55011, the following applies: This device has been developed and tested in accordance with CISPR 11 Class A. The device may cause radio interference in domestic environments and is not intended for use in residential areas. The device cannot ensure adequate protection of radio reception in residential areas and domestic environments.

- ▶ If necessary, take appropriate measure to eliminate the interferences.
-



Mains/power connection for centrifuges: Operation of the centrifuge is only permitted in building installations that comply with the applicable national regulations and standards. In particular, it must be ensured that there are no impermissible loads on the supply lines and assemblies that are located upstream of the internal protection of the device. This can be ensured by additional circuit breakers or other suitable safety elements in the building installation.



The mains/power switch and the disconnecting device of the mains/power line must be easily accessible during operation (e.g. a residual current circuit breaker).

Installation

Centrifuge 5425 R
English (EN)

Select the location of the device according to the following criteria:

- Mains/power connection in accordance with the name plate
 - Minimum distance to other devices and walls: 30 cm
 - Resonance free table with horizontal even work surface
 - The surrounding area must be well ventilated.
 - The location is protected against direct sunlight.
- ▶ Do not use this device near strong electromagnetic sources (e.g. unshielded high frequency sources) as they could impede proper functioning of the device.

4.2 Preparing installation

Prerequisites

The weight of the Centrifuge 5425 R is 21 kg. For unpacking and installing the Centrifuge 5425 R, you require the assistance of another person.

Perform the following steps in the sequence described:

1. Open the packaging box.
2. Remove the accessories.
3. Reach with your hands under the device and lift the centrifuge from the carton with another person.
4. Remove the front and back transport protection pads.
5. Place the device on a suitable lab bench.
6. Remove the plastic sleeve.

4.3 Installing the instrument

Prerequisites

The device is on a suitable lab bench.



WARNING! Danger due to incorrect voltage supply.

- ▶ Only connect the device to voltage sources which correspond with the electrical requirements on the name plate.
- ▶ Only use earth/grounded sockets with a protective earth (PE) conductor.
- ▶ Only use the mains/power cord supplied.



NOTICE! Damage to electronic components due to condensation.

Condensate may form in the device when it has been transported from a cool environment to a warmer environment.

- ▶ After installing the device, wait for at least 4 h. Only then connect the device to the mains/power line.



NOTICE! Compressor damage after improper transport.

- ▶ After installation, wait 4 h before switching on the centrifuge.
-

1. Let the device warm up to ambient temperature.
2. Check that the mains voltage and frequency match the requirements on the device type plate.
3. Connect the centrifuge to the mains/power line and switch it on at the mains/power switch.
 - The display is active.
 - Lid opens automatically
4. **Only device version with rotor:** Turn rotor counterclockwise supplied rotor key and remove rotor towards the top in an upright movement.
5. Remove the transport protection pad.
6. Place the rotor vertically on the motor shaft.
7. Turn the rotor nut using the rotor key clockwise until the rotor nut is tightened.
8. Insert the condensation water tray into the holder provided.

5 Operation

5.1 Operating controls

The Centrifuge 5425 R is available in two versions: keypad or rotary knobs. This operating manual generally describes the operation of the keypad version. It also applies to the rotary knob version, however.

Familiarize yourself with the operating controls and the display before using the Centrifuge 5425 R for the first time.

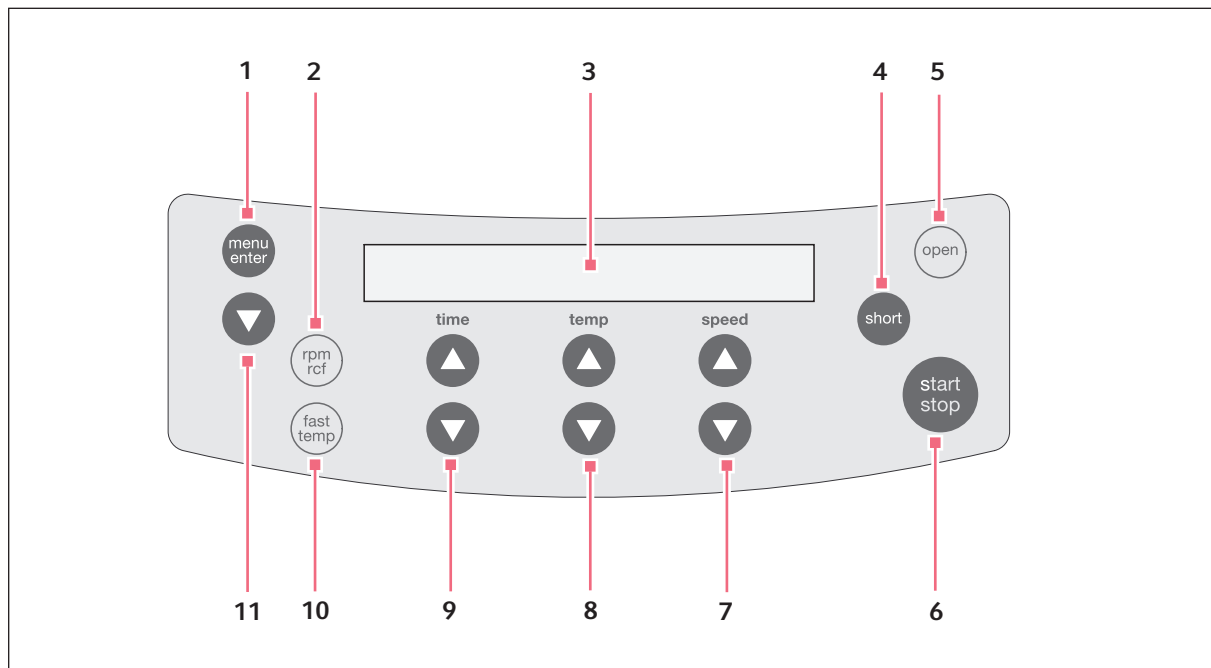

Fig. 5-1: Control panel of the Centrifuge 5425 R

- | | |
|--|---|
| <p>1 Calls up and selects menu parameters</p> <p>2 Switches the displayed centrifugation speed (rpm/rcf)</p> <p>3 Display</p> <p>4 Short run centrifugation</p> <p>5 Releases the lid</p> <p>6 Starts and stops centrifugation</p> | <p>7 Sets the speed of centrifugation
Designed as keys or a dial, depending on the device version.</p> <p>8 Sets the temperature</p> <p>9 Sets the centrifugation time
Designed as keys or a dial, depending on the device version.</p> <p>10 Starts a fast temp temperature control run</p> <p>11 Selects a menu item</p> |
|--|---|

Please also read the precise description of the individual menu functions (see p. 27).

Operation

Centrifuge 5425 R
English (EN)

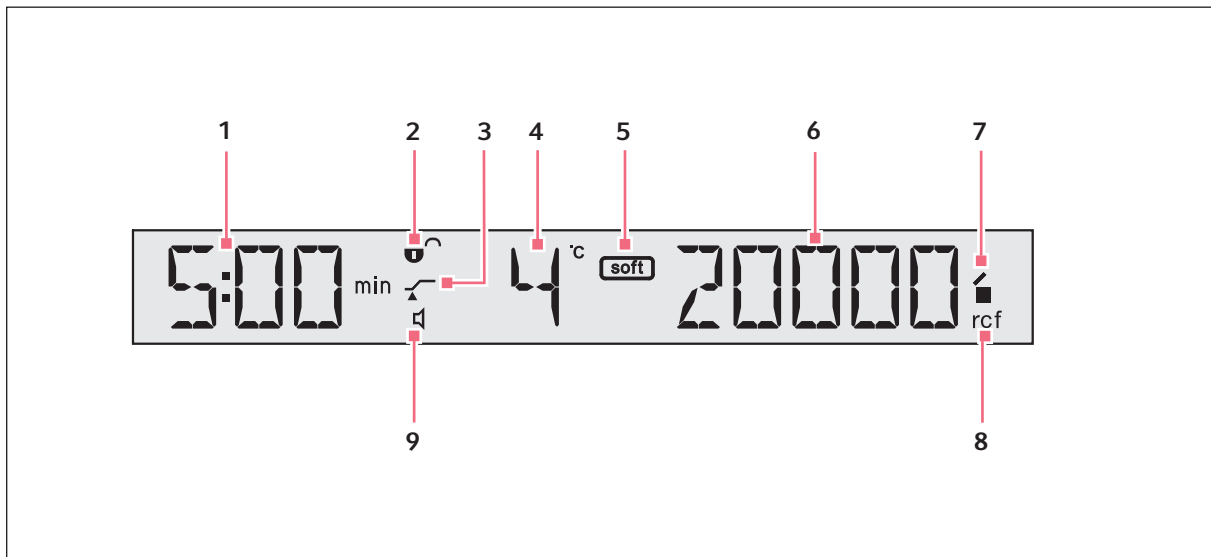

Fig. 5-2: Display of the Centrifuge 5425 R

1 Centrifugation time

2 Status of the key lock (LOCK)

🔒: Centrifugation parameters cannot be modified unintentionally.

🔓: No key lock.

3 Status of ATSET function

✓: Start of run time when reaching 95% of the preset *g*-force (rcf) or speed (rpm).

⚡: Immediate start of run time.

4 Temperature

5 Soft ramp

soft: Rotor accelerates and brakes slowly.

No symbol: Rotor accelerates and brakes rapidly.

6 *g*-force (rcf) or speed (rpm)

7 Centrifuge status

🔓: Centrifuge lid unlocked.

🔒: Centrifuge lid locked.

■ (Flashes): centrifugation in progress.

8 Status of centrifugation speed display

rcf: *g*-force (relative centrifugal force, rcf)





rpm: Speed (revolutions per minute)

9 Loudspeaker status

🔊: Switched on

🔇: Switched off

5.2 Navigating in the menu





1.		To open the menu, press the menu/enter key.
2.		Select the menu item with the menu arrow keys.
3.		To confirm your selection, press the menu/enter key.
4.		Change the settings with the menu arrow key.
5.		To confirm your selection, press the menu/enter key.





► In order to leave a menu level, select *BACK* and confirm with the **menu/enter** key.

5.3 Menu structure

Tab. 5-1: Menu structure of the Centrifuge 5425 R. All menu levels contain the additional menu item **Back**.

Level 1 (M 1)	Level 2 (M 2)	Function	Display
SOFT Soft ramp: Reduce the speed of the acceleration and braking ramp. Not used for short run centrifugation.	ON	Rotor accelerates and brakes slowly.	
	OFF	Rotor accelerates and brakes rapidly.	
LOCK Key lock: Set the current centrifugation parameters permanently to prevent the time, temperature (only 5425 R), <i>g</i> -force (rcf) or speed (rpm) from being unintentionally modified.	ON	Set the centrifugation parameters permanently. When you select the time , temp and speed keys, the display shows SAFE .	
	OFF		
ATSET Set start of centrifuging run time.	ON	The set time is counted down only once 95% of the specified <i>g</i> -force (rcf) or speed (rpm) has been reached.	
	OFF	The set time is counted down immediately.	
SHORT Before the start of a short run it is possible to switch between the maximum and currently set <i>g</i> -force (rcf) or speed (rpm). The SOFT function is not used for short run centrifugation.	MAX	Short spin run at maximum <i>g</i> -force (rcf) or speed (rpm) of the rotor used.	
	SET	Short run at set <i>g</i> -force (rcf) or speed (rpm).	
TEMP Set the time limit for continuous cooling (see p. 34).	8 h	Preset value.	
	oo	Endless operation of continuous cooling. Icing possible! Note that this may reduce the service life of the compressor.	

Level 1 (M 1)	Level 2 (M 2)	Function	Display
ALARM	ON	Switch on loudspeaker.	
	OFF	Switch off loudspeaker.	
VOL	VOL1 ... VOL5	Adjust the speaker volume in 5 steps. The loudspeaker must be switched on for the adjustment to be audible.	
SLEEP Standby mode	ON	If the centrifuge has not been used for 15 min and the standby mode has been switched on, it switches to standby mode. The EP logo then appears in the display. When a button or knob is used or the centrifuge lid is closed, the centrifuge is reactivated. It is then ready for operation.	
	OFF	Standby mode deactivated.	

5.4 Preparing for centrifugation

5.4.1 Switching on the centrifuge

1. Switch on the centrifuge at the mains/power switch.
After switching the device on at the mains/power switch, the centrifuge lid opens automatically.
2. Open the closed centrifuge lid by pressing the **open** key.
The parameter settings of the last run are displayed.

5.4.2 Removing the rotor

1. Turn the rotor nut counterclockwise with the rotor key included in the delivery.
2. Lift the rotor out vertically.

5.4.3 Inserting the rotor

1. Place the rotor vertically on the motor shaft.
2. Insert the supplied rotor key into the rotor nut.
3. Turn the rotor key clockwise until the rotor nut is firmly tightened.



The centrifuge does not detect the new rotor immediately after a rotor change. For this reason, carry out a rotor detection during which the set *g*-force (rcf) or speed (rpm) is checked and, if necessary, adjusted after each rotor change.

5.4.4 Triggering rotor detection



CAUTION! Risk of injury when turning the rotor manually.

- ▶ When turning a swing-bucket rotor, pay special attention to ensure that your fingers do not get jammed or get caught on the swinging buckets.
-

The centrifuge does not detect automatically whether the newly inserted rotor is a fixed-angle rotor or a swing-bucket rotor.

1. In order to trigger rotor detection manually, turn the rotor **counterclockwise** by hand.



Triggering rotor detection using short run centrifugation

- ▶ Keep the **short** key pressed.
In the case of fixed-angle rotors, **High Speed** appears on the display.
In the case of swing-bucket rotors, **Low Speed** appears on the display.

5.4.5 Loading the rotor



CAUTION! Risk of injury due to asymmetric loading of a rotor.

- ▶ Load rotors symmetrically with identical tubes.
- ▶ Only load adapters with suitable tubes.
- ▶ Always use the same type of tubes (weight, material/density and volume).
- ▶ Check that loading is symmetrical by balancing the adapters and tubes used with a balance.



CAUTION! Risk from damaged or overloaded tubes.

- ▶ When loading the rotor, observe the safety instructions for hazards resulting from overloaded or damaged tubes.
-



Rotor lid

- Fixed-angle rotors may only be operated with the appropriate rotor lid in each case. This is clearly shown by the identical rotor name labeling on the rotor and on the rotor lid.
- To carry out an aerosol-tight centrifugation, an aerosol-tight rotor (label: **red ring**) and the corresponding aerosol-tight rotor lid (label: **aerosol-tight** and **red lid screw**) must be used.

To load the rotor, proceed as follows:

1. Check the maximum load (adapter, tube and contents) per rotor bore.
The information about this can be found on every rotor and in this operating manual (see *on p. 55*).
2. Load rotors and adapters only with the tubes intended for them.

3. Insert tubes opposite each other in pairs into the rotor bores. To ensure symmetric loading, tubes that are arranged opposite each other must be of the same type and contain the same filling quantity.

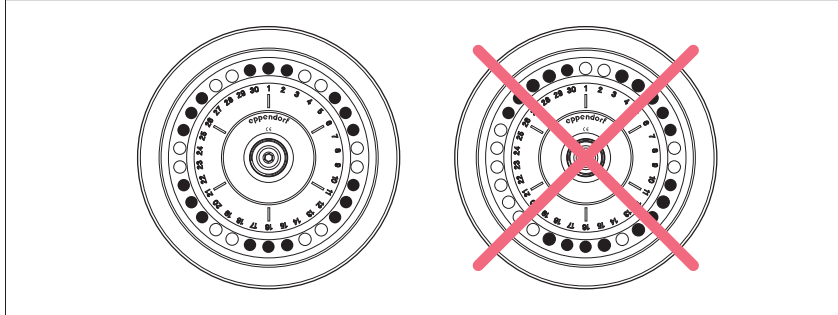

To keep the weight differences between the filled sample tubes low, we recommend taring with a balance. This protects the drive and reduces operating noise.

4. Attach and tighten the rotor lid.



With the rotors FA-24x2, FA-18x2-KIT and FA-10x5, centrifugation is also possible without a rotor lid.

Please also note:

- The tube lids must be closed securely.
- The rotors are not aerosol-tight without rotor lid.
- The centrifugation is slightly louder.
- Spin columns must always be centrifuged with a rotor lid.



Spin columns

When centrifuging spin columns in the rotor FA-18x2-KIT, you can leave the tube lids open. However, this is only permitted with the tubes specified by the kit manufacturers. For reliable centrifugation, you must lean the open tube lids against the edge of the rotor. Ensure that the lids do not protrude past the edge of the rotor in the process, then attach the matching rotor lid.

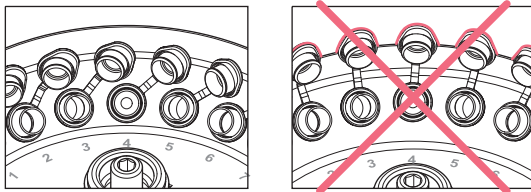



Note on loading the rotor S-96x0.2

In split PCR plates, two of the four plate parts always have a wider edge on one side. Insert these plate parts with the wider edge facing inwards into the rotor. Make sure that the PCR plates with a wide edge are always placed opposite each other in the rotor otherwise an imbalance will occur during operation.

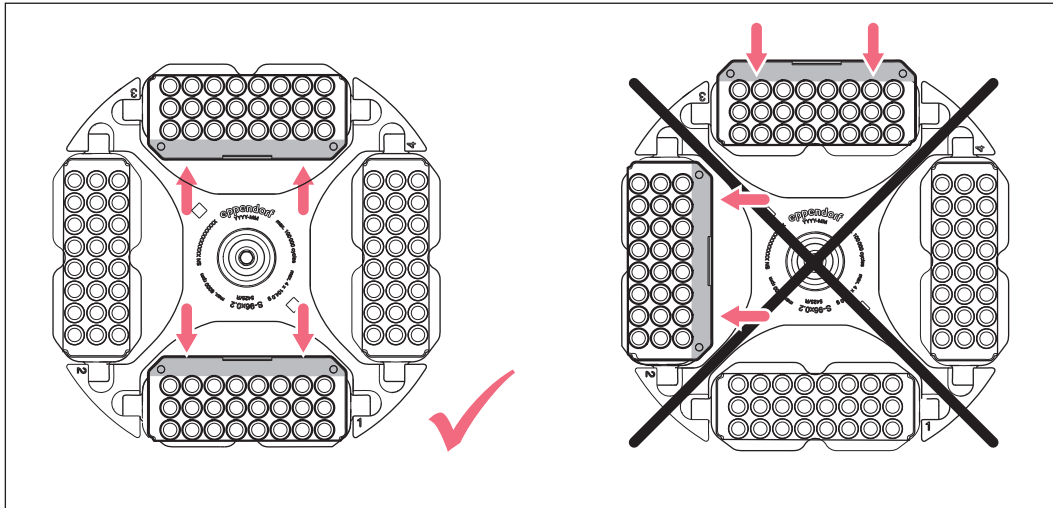

5.4.6 Closing the centrifuge lid



WARNING! Risk of injury when opening or closing the centrifuge lid

There is a risk of crushing your fingers when opening or closing the centrifuge lid.

- ▶ Do not reach between the device and centrifuge lid when opening or closing the centrifuge lid.
- ▶ Do not reach into the locking mechanism of the centrifuge lid.
- ▶ Open the centrifuge lid fully to ensure that the centrifuge lid cannot slam shut.

1. Check correct attachment of rotor and rotor lid.
2. Push down the centrifuge lid until the lid latch engages and the lid is automatically closed.

The centrifuge will close automatically.

The **open** key lights up blue. The display shows the symbol ■.

5.4.7 Closing the QuickLock rotor lid

Aerosol-tight rotors have a QuickLock rotor lid.



Identification of aerosol-tight rotors

An aerosol-tight rotor and the matching aerosol-tight rotor lid must be used for aerosol-tight centrifugation.

Aerosol-tight fixed-angle rotor

- Designation begins with **FA**
- **Red ring**

Aerosol-tight rotor lid

- Labeled **aerosol-tight**
- **Red lid screw**

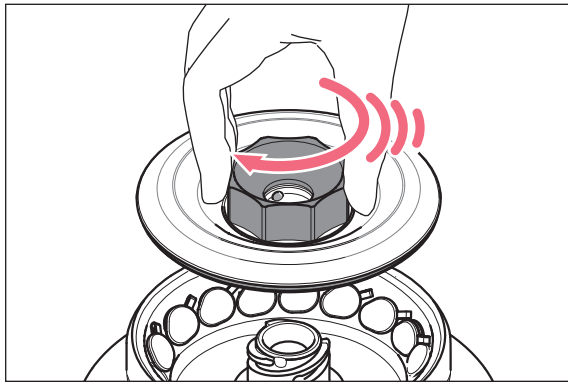

1. Check the correct positioning of the external sealing ring in the groove.
2. Place the rotor lid on the rotor in a vertical motion.
3. To lock the rotor, turn the red rotor lid screw clockwise as far as it will go, and after an audible "click" is heard.



The rotor is only properly locked after the audible "click" is heard!

5.5 Cooling

5.5.1 Temperature adjustment

- ▶ Select a temperature (-10 °C to +40 °C) using the arrow keys **temp**.
The temperature can also be changed during centrifugation.

5.5.2 Temperature display

If the rotor is stopped:	Set temperature
During centrifugation:	Actual temperature

5.5.3 Temperature monitoring

After the set temperature has been reached, the centrifuge reacts to temperature deviations during centrifugation as follows:

Deviation from the target value	Action
$\Delta T > 3 \text{ }^\circ\text{C}$	Temperature display flashes.
$\Delta T > 5 \text{ }^\circ\text{C}$	Display <i>Error 18</i> . Centrifugation is stopped automatically.

5.5.4 FastTemp

With this function, you can immediately start a temperature run without samples, at rotor- or temperature-specific speeds. This will quickly bring the rotor chamber, including rotor and adapter, up to the set target temperature.

Prerequisites

- The centrifuge is switched on.
- The rotor and rotor lid are attached properly.
- The centrifuge lid is closed.
- The temperature and *g-force* (rcf)/speed (rpm) have been set for the upcoming centrifugation.

1. Press the **fast temp** key.

The display shows *FT*, the current temperature and *g-force* (rcf)/speed (rpm).

The temperature control run ends automatically when the set temperature is reached. A periodic signal tone sounds.

2. Press the **start/stop** key to end the temperature control run early.

After the temperature control run has ended, the centrifuge maintains the rotor chamber temperature at the target temperature when the centrifuge lid is closed, if the target temperature is below the ambient temperature. However, independent of the target temperature, 4 °C must be met via this continuous cooling in order to prevent the rotor chamber from freezing.

5.5.5 Continuous cooling

If the rotor stops, the rotor chamber will be maintained at the set temperature if the following requirements have been met:

- The centrifuge is switched on.
- The centrifuge lid is closed.
- The set temperature is lower than the ambient temperature.

The following factors apply during the continuous cooling:

- The set temperature will be displayed.
- Independent of the set temperature, 4 °C must be achieved in order to prevent the rotor chamber or sample from freezing and to prevent increased condensation in the device.
- The temperature adjustment takes longer because the rotor is not rotating.

Open the centrifuge lid to end continuous cooling.

If the centrifuge is not used for more than 8 hours, the continuous cooling is switched off automatically. This protects against ice formation in the rotor chamber and the tubes, and against increased condensation in the device.

The device then switches to standby mode. The display shows *EP*.

You can change continuous cooling to endless operation. To do so, enable the 'oo' option in the device menu under *TEMP*. Note that this may reduce the service life of the compressor.

5.6 Centrifugation



CAUTION! Danger due to incorrectly loaded rotors and damaged/overloaded tubes!

- ▶ Before commencing centrifugation, follow the safety instructions relating to risks from asymmetrically loaded and/or overloaded rotors and from overloaded, damaged and/or open tubes.



WARNING! Risk of injury from improperly attached rotors and rotor lids.

- ▶ Only centrifuge with the rotor and rotor lid firmly tightened.
 - ▶ If unusual noises occur when the centrifuge starts, the rotor or the rotor lid may not be attached properly. Stop the centrifugation immediately.
-

Familiarize yourself with the operating controls and the display before using the Centrifuge 5425 R for the first time.

Each of the centrifuging variants described here must be preceded by the preparation described above.

Please also note the instructions on cooling (see p. 32).

5.6.1 Centrifuging with time setting

Perform the following steps in the sequence described:

1. Use **time** to set the run time.
2. Use **temp** to set the temperature.
3. Use **speed** to set the *g*-force (rcf) / speed (rpm).
4. Press **start/stop** to start the centrifugation.

During centrifugation

- ■ flashes on the display while the rotor is running.
- The current temperature is displayed.
- The **fast temp, open, short** as well as the device menu are blocked during centrifugation.
- You can also terminate the centrifugation before the set run time has elapsed by pressing the **start/stop** key.

End of centrifugation

- The centrifuge stops automatically when the set time has elapsed. During the braking process, the elapsed centrifugation time flashes on the display. When the rotor has stopped, a signal tone sounds and the time from when the rotor stopped and **END** is shown on the display. After a stop period of more than 9:59 h, **oo** appears on the display.
- The centrifuge lid remains closed to maintain the sample temperature. You can open it by pressing the **open** key.

5. Remove the material for centrifuging.

5.6.2 Centrifuging in continuous operation

Perform the following steps in the sequence described:

1. Use **time** to set the continuous run.
The continuous run function can be set above 9:59 h or below 10 s. The timer shows **oo** to indicate continuous operation.
2. Use the **temp** arrow keys to adjust the temperature.
3. Use **speed** to set the *g*-force (rcf) or speed (rpm).
4. Press **start/stop** to start centrifuging.
■ flashes on the display while the rotor is running.
The run time is counted up.
5. Press **start/stop** to end centrifuging after the desired time period.
 - During the braking process, the centrifugation time flashes on the display.
 - When the rotor has stopped, a signal tone sounds.
 - The centrifuge lid remains closed to maintain the sample temperature. You can open it by pressing the **open** key.
6. Remove the material for centrifuging.

5.6.3 Short run centrifugation

You can carry out a short run with the currently set or with the maximum g -force (rcf) or speed (rpm) of the rotor used. This is set in the menu structure (see *Menu structure on p. 27*) before executing the following steps in the sequence specified:

5.6.3.1 Performing short run centrifugation

1. A short run at current speed/ g -force (rcf) or speed (rpm) can be set directly using the **speed** arrow keys.
2. Use the **temp** arrow keys to adjust the temperature.
3. Start short run: Press or press and hold the **short** key.



Functions of the **short** key:

- Pressing and holding the **short** key: the centrifuge runs for as long as the **short** key is pressed.
 - Briefly pressing the **short** key: the centrifuge accelerates up to the set speed (MAX or SET) and stops the short run shortly afterwards.
- ■ flashes on the display while the rotor is running.
 - The time is counted upwards in seconds.
 - During short run centrifuging all other keys are blocked.
4. End short run: Release the **short** key.
 - During the braking process, the centrifugation time flashes on the display.
 - The centrifuge lid remains closed to maintain the sample temperature. You can open it by pressing the **open** key.
 5. Remove the material for centrifuging.



During the braking process, you can restart centrifugation up to two times by pressing the **short** key again.



The soft ramp does not work during short run centrifugation.

5.7 Aerosol-tight centrifugation



WARNING! Damage to health due to limited aerosol tightness with an incorrect rotor/ rotor lid combination.

Aerosol-tight centrifugation is guaranteed only if the rotors and rotor lids intended for this purpose are used. The designation of aerosol-tight fixed-angle rotors always starts with **FA**. The aerosol-tight rotors and rotor lids of this centrifuge are additionally marked with a red ring on the rotor and a red rotor lid screw.

- ▶ Always use rotors and rotor lids marked aerosol-tight together for aerosol-tight centrifugation. The details specifying in which centrifuge the aerosol-tight rotors and rotor lids may be used can be found on the rotor and on the top of the rotor lid.
- ▶ Only use aerosol-tight rotor lids in combination with the rotors that are specified on the rotor lid.



WARNING! Damage to health due to limited aerosol-tightness if used incorrectly.

Mechanical stresses and contamination by chemicals or other aggressive solvents may impair the aerosol tightness of the rotors and rotor lids. Autoclaving at excessive temperatures can lead to plastic vessels, adapters and rotor lids becoming brittle and deformed.

- ▶ Check the integrity of the seals of the aerosol-tight rotor lids or caps before each use.
- ▶ Only use aerosol-tight rotor lids or caps if the seals are undamaged and clean.
- ▶ Do not exceed temperatures of 121 °C or a time of more than 20 min while autoclaving.
- ▶ After each proper autoclaving process (121 °C, 20 min), coat the threads of the rotor lid screw with a thin layer of pivot grease (order no. Int. 5810 350.050, North America 022634330).
- ▶ Only the seal of aerosol-tight rotor lids with exchangeable seals (e.g. QuickLock rotor lids) must be replaced after 50 autoclaving cycles.
- ▶ **Never** store aerosol-tight rotors or buckets closed.



The aerosol tightness of rotors, rotor lids, buckets and caps has been tested and certified according to Annex AA of IEC 61010-2-020.

5.7.1 Aerosol-tight centrifugation in a fixed-angle rotor

To ensure aerosol tightness, the following applies:

- Replace aerosol-tight rotor lids without exchangeable seal and cap after 50 autoclaving cycles.
- Replace the seal of aerosol-tight rotor lids with exchangeable seal (e.g. QuickLock rotor lids) after 50 autoclaving cycles.
- Lightly grease the replaced seal with pivot grease after it is inserted.

6 Maintenance

6.1 Service



WARNING! Risk of fire or electrical shock

- ▶ Have the centrifuge's electrical safety, especially the paths for the protective connections, checked every 12 months by trained and skilled personnel.

We recommend to have the centrifuge and the associated rotors checked by Technical Service during a service at least every 12 months. Please note the country-specific regulations.

6.2 Preparing cleaning/disinfection

- ▶ Clean all accessible surfaces of the device and the accessories at least weekly and when contaminated.
- ▶ Clean the rotor regularly. This way the rotor is protected and the durability is prolonged.
- ▶ Furthermore, observe the notes on decontamination (see *Decontamination before shipment on p. 44*) when the device is sent to the authorized Technical Service for repairs.

The procedure described in the following chapter applies to the cleaning as well as to the disinfection or decontamination. The table below describes the steps required on top of this:

Cleaning	Disinfecting/decontamination
<ol style="list-style-type: none"> 1. Use a mild cleaning fluid to clean the accessible surfaces of the device and the accessories. 2. Carry out the cleaning as described in the following chapter. 	<ol style="list-style-type: none"> 1. Choose the disinfection method which corresponds to the legal regulations and guidelines in place for your range of application. For example, use alcohol (ethanol, isopropanol) or alcohol-based disinfectants. 2. Carry out the disinfection or decontamination as described in the following chapter. 3. Then clean the device and the accessories.



If you have any further questions regarding the cleaning and disinfection or decontamination or regarding the cleaning fluid to be used, contact the Eppendorf AG Application Support. The contact details are provided on the back of this manual.

6.3 Cleaning/disinfection



DANGER! Electric shock due to the ingress of liquid.

- ▶ Switch off the device and disconnect it from the mains/power line before starting cleaning or disinfection.
 - ▶ Do not allow any liquids to penetrate the inside of the housing.
 - ▶ Do not perform a spray clean/spray disinfection on the housing.
 - ▶ Only reconnect the device to the mains/power line when it is completely dry, both inside and outside.
-



WARNING! Damage to health due to limited aerosol-tightness if used incorrectly.

Mechanical stresses and contamination by chemicals or other aggressive solvents may impair the aerosol tightness of the rotors and rotor lids. Autoclaving at excessive temperatures can lead to plastic vessels, adapters and rotor lids becoming brittle and deformed.

- ▶ Check the integrity of the seals of the aerosol-tight rotor lids or caps before each use.
 - ▶ Only use aerosol-tight rotor lids or caps if the seals are undamaged and clean.
 - ▶ Do not exceed temperatures of 121 °C or a time of more than 20 min while autoclaving.
 - ▶ After each proper autoclaving process (121 °C, 20 min), coat the threads of the rotor lid screw with a thin layer of pivot grease (order no. Int. 5810 350.050, North America 022634330).
 - ▶ Only the seal of aerosol-tight rotor lids with exchangeable seals (e.g. QuickLock rotor lids) must be replaced after 50 autoclaving cycles.
 - ▶ **Never** store aerosol-tight rotors or buckets closed.
-



NOTICE! Damage from the use of aggressive chemicals.

- ▶ Do not use any aggressive chemicals on the device or its accessories, such as strong and weak bases, strong acids, acetone, formaldehyde, halogenated hydrocarbons or phenol.
- ▶ If the device has been contaminated by aggressive chemicals, clean it immediately using a mild cleaning agent.



NOTICE! Corrosion due to aggressive cleaning agents and disinfectants.

- ▶ Do not use any corrosive cleaning agents, aggressive solvents or abrasive polishes.
- ▶ Do not incubate the accessories in aggressive cleaning agents or disinfectants for longer periods.



NOTICE! Damage from UV and other high-energy radiation.

- ▶ Do not use UV, beta, gamma, or any other high-energy radiation for disinfection.
 - ▶ Avoid storage in areas with strong UV radiation.
-



Autoclaving

Rotors, rotor lids and adapters can be autoclaved (121 °C, 20 min).
Replace the seal on aerosol-tight rotor lids after 50 autoclaving cycles.



Aerosol tightness

Check that the seals are intact before use.
Replace the rotor lids with screw cap when the sealing rings on the lid screw and in the lid groove become worn.
Regular care of the sealing rings is necessary in order to protect the rotors.
Aerosol-tight rotors should never be stored with the lids screwed on!
In order to prevent damage, lightly grease the lid threads of aerosol-tight rotors regularly with pivot grease (order no. int.: 5810 350.050/North America: 022634330).

6.3.1 Cleaning and disinfecting the device

1. Open the lid. Switch the device off at the mains/power switch. Disconnect the mains/power plug from the voltage supply.
2. Loosen the rotor nut by turning it counterclockwise with the rotor key.
3. Remove the rotor.
4. Clean and disinfect all accessible surfaces on the device including the mains/power cord using a damp cloth and recommended cleaning agents.
5. Thoroughly clean the rubber seal of the rotor chamber with water.
6. Rub the dry rubber seal with glycerol or talcum powder to prevent it from becoming brittle. Other components of the device, such as the motor shaft and rotor cone, must not be lubricated.
7. Clean the motor shaft with a soft, dry, lint-free cloth. Do not grease the motor shaft.
8. Check the motor shaft for damage.
9. Check the device for corrosion and damage.
10. Leave the centrifuge lid open when the device is not being used.
11. Only reconnect the device to the mains/power supply if it is fully dry on the inside and outside.

6.3.2 Cleaning and disinfecting the rotor

1. Inspect the rotor and accessories for damage and corrosion. Do not use damaged rotors or accessories.
2. Clean and disinfect the rotors and accessories with the recommended cleaning agents.
3. Clean and disinfect the rotor bores with a bottle brush.
4. Rinse the rotors and accessories thoroughly with distilled water. Rinse the rotor bores of fixed-angle rotors particularly thoroughly.



Do not immerse the rotor in liquid as liquid can enter through the openings when doing so.

5. Place the rotors on a towel to dry. Place fixed-angle rotors with the rotor bores facing down so the bores can also dry.
6. Clean the rotor cone with a soft, dry, lint-free cloth. Do not lubricate the rotor cone.
7. Inspect the rotor cone for damage.
8. Place the dry rotor onto the motor shaft.
9. Tighten the rotor nut by turning it **clockwise**.
10. Leave the rotor lid open when the rotor is not being used.

6.3.3 Cleaning and disinfecting the rotor lid

Prerequisites

The rotor lid has been removed.

Recommended cleaning agents:

- Alcohol 70 % (ethanol, isopropanol)
- Mild neutral cleaning agent

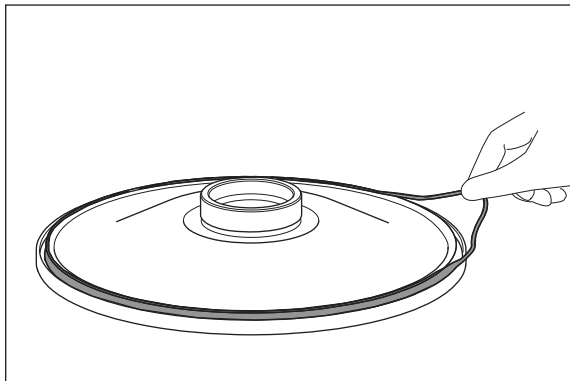

1. Remove the sealing ring to thoroughly clean the groove below it.
2. Clean and disinfect the rotor lid using the recommended cleaning agents.
3. Rinse the rotor lid thoroughly with distilled water.
4. Moisten the new sealing ring with clean water.

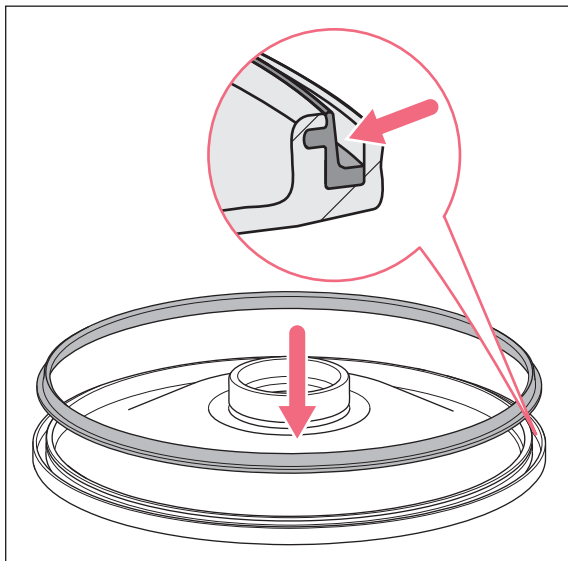

5. Insert the sealing ring in the clean groove of the rotor lid.
6. Press the sealing ring into the lateral groove, around the entire circumference of the rotor lid.
7. Place the rotor lid with the underside facing upwards on a cloth.
8. Leave the rotor lid to dry for 5 –10 minutes.
9. Perform a visual inspection.
The seal must be flush with the groove of the rotor lid around the entire circumference and must not protrude at any point.
10. Fit the rotor lid on the rotor.
11. Leave the rotor lid open when the rotor is not being used.



The rotor lid cannot close properly if the sealing ring is not correctly inserted.

6.4 Additional care instructions for refrigerated centrifuges.

- ▶ Empty and clean the condensation water tray regularly and especially after liquid spillage in the rotor chamber. Pull out the condensation water tray at the front right under the device.
- ▶ Regularly clear the rotor chamber of ice formations via defrosting, either by leaving the centrifuge lid open or carrying out a brief temperature control run at approx. 30°C.
- ▶ To relieve the gas springs in the centrifuge lid, leave the centrifuge lid open when not in use for a long period.
Residual moisture can escape.
- ▶ Wipe up condensate in the rotor chamber. Use a soft absorbent cloth for this.
- ▶ No later than every 6 months, remove any dust deposits from the ventilation slits of the centrifuge using a brush or swab. First switch off the device and remove the power plug.

6.5 Cleaning glass breakage

When using glass tubes there is a risk of glass breakage in the rotor chamber. The resulting glass splinters are swirled around in the rotor chamber during centrifugation and have a sandblasting effect on the rotor and accessories. Very small particles of glass can become lodged in the rubber parts (e.g., the motor sleeve, the rotor chamber seal, and the rubber mats of adapters).



NOTICE! Glass breakage in the rotor chamber

Glass tubes in the rotor chamber may break if the *g*-force is too high. Broken glass can damage the rotor, accessories and samples.

- ▶ Please note the manufacturer's information on the recommended centrifugation parameters (load and speed).
-

Effects of glass breakage in the rotor chamber:

- Fine black metal abrasion dust in the rotor chamber (with metal rotor bowls).
- The surfaces of the rotor chamber and accessories are scratched.
- The chemical resistance of the rotor chamber is reduced.
- Contamination of samples.
- Wear on rubber parts.

How to proceed in case of glass breakage

1. Remove all splinters and glass powder from the rotor chamber and accessories.
2. Thoroughly clean the rotor and rotor chamber. Thoroughly clean the bores of the fixed-angle rotors, in particular.
3. If required, replace the adapters to prevent any further damage.
4. Regularly check the rotor bores for deposits and damage.

6.6 Fuses

1. Disconnect the mains/power plug.
2. Remove the fuse holder.

Both fuses are now accessible and can be replaced.

6.7 Decontamination before shipment

If you are shipping the device to the authorized Technical Service for repairs or to your authorized dealer for disposal please note the following:



WARNING! Risk to health from contaminated device.

1. Observe the information in the decontamination certificate. It is available as a PDF document on our webpage (www.eppendorf.com/decontamination).
 2. Decontaminate all the parts you are going to dispatch.
 3. Include the fully completed decontamination certificate in the shipment.
-

7 Troubleshooting

If you cannot remedy an error with the recommended measures, please contact your local Eppendorf partner. The contact address can be found on the Internet at www.eppendorf.com.

7.1 General errors

Problem	Cause	Solution
No display.	No mains/power connection.	▶ Check the mains/power connection.
	Mains/power outage.	▶ Check the fuse of the centrifuge. ▶ Check the mains/power fuse of the lab.
Centrifuge lid cannot be opened.	The rotor is still running.	▶ Wait for the rotor to stop.
	Mains/power outage.	1. Check the fuse of the centrifuge. 2. Check the mains/power fuse of the lab. 3. Activate the emergency lid release.
Centrifuge cannot be started.	The centrifuge lid is not closed.	▶ Close the centrifuge lid.
Centrifuge shakes when it starts up.	The rotor is loaded asymmetrically.	1. Stop the centrifuge and load symmetrically. 2. Restart the centrifuge.
Centrifuge brakes during a short run centrifugation, although the short key is pressed.	The short key was released briefly more than twice (protective function for the drive).	▶ Press the short key continuously during a short run centrifugation.
Temperature display flashes.	• Temperature deviation from set value: ± 3 °C.	▶ Check the settings. ▶ Wait until the set temperature has been reached. ▶ Check unhindered air circulation through the air slots. ▶ Thaw ice or switch off the centrifuge and allow it to cool down.

7.2 Error messages

If the following error messages appear, proceed as follows:

1. Remedy the fault (see Remedy).
2. If necessary, repeat centrifugation.

Problem	Cause	Solution
LID ERROR	Centrifuge lid cannot be locked.	▶ Try to close the centrifuge lid again.
	Centrifuge lid cannot be released.	1. Switch the centrifuge off and back on. If the error occurs again: 1. Switch off the centrifuge. 2. Activate the emergency lid release.
	Centrifuge lid must not be released during a run.	▶ Wait for the rotor to stop.
LID LIFT	<ul style="list-style-type: none"> • The centrifuge lid has not been opened wide enough. 	▶ Open the centrifuge lid wider by hand.
INT	Mains/power failure during a run.	▶ Check the mains/power connection.
NO RPM	Error in the rotational speed measurement system.	▶ Leave the device switched on until the error message disappears (10 s or 6 min).
Err 6	Drive fault.	<ul style="list-style-type: none"> ▶ Repeat the run. ▶ If this error message appears again, switch centrifuge off and back on again after >20 s.
	The drive is overheated.	▶ Allow the drive to cool down for at least 15 min.
Err 7	Major deviation in the speed check.	<ol style="list-style-type: none"> 1. Wait for the rotor to stop. 2. Tighten the rotor.
Err 8		<ol style="list-style-type: none"> 1. Wait for the rotor to stop. 2. Repeat the run.
Err 9 to 17	Electronics error.	▶ Switch the centrifuge off and back on again after > 20 s.
Err 18	Too high temperature deviation from set value in the rotor chamber.	<ul style="list-style-type: none"> ▶ Check the settings. ▶ Check unhindered air circulation through the air slots. ▶ Thaw ice or switch off the centrifuge and allow it to cool down.
Err 19	Cooling circuit is overheated.	▶ Check unhindered air circulation through the air slots and allow the centrifuge to cool down.
Err 20	Temperature sensor in rotor chamber is faulty.	▶ Switch the centrifuge off and back on again after > 20 s.

Problem	Cause	Solution
Err 21	The temperature sensor on the condenser is faulty.	▶ Switch the centrifuge off and back on again after > 20 s.
Err 24	Cooling aggregate fault, e.g., overheated.	▶ Allow the centrifuge to cool down and repeat the run.

7.3 Emergency release

If the centrifuge lid cannot be opened, you can activate the emergency release manually.



WARNING! Risk of injury from rotating rotor.

If the emergency release of the lid is activated, the rotor may continue to rotate for several minutes.

- ▶ Wait for the rotor to stop before activating the emergency release.
- ▶ To check, look through the monitoring glass in the centrifuge lid.



Use the rotor key delivered with the Centrifuge 5425 R for the emergency release.

1. Disconnect the mains/power plug.
2. Remove the plastic cover for the emergency release on the right side of the device. Turn the plastic cover 90° **counterclockwise** using an appropriate tool (e.g., screwdriver) and remove it.
3. Insert the centrifuge rotor key in the rear hexagonal opening until a noticeable resistance is felt.
4. **Slightly press** and turn the rotor key counterclockwise.
This will release the centrifuge lid.
5. Open the centrifuge lid.
6. Remove the rotor key and fit or turn the plastic covers back on.

8 Transport, storage and disposal

8.1 Transport



CAUTION! Risk of injury due to lifting and carrying of heavy loads

The device is heavy. Lifting and carrying the device can lead to back injuries.

- ▶ Transport and lift the device with an adequate number of helpers only.
- ▶ Use a transport aid for transporting the device.

- ▶ Remove the rotor from the centrifuge before transport.
- ▶ Use the original packing for transport.

	Air temperature	Relative humidity	Atmospheric pressure
General transport	-25 °C – 60 °C	10 % – 75 %	30 kPa – 106 kPa
Air freight	-20 °C – 55 °C	10 % – 75 %	30 kPa – 106 kPa

8.2 Storage

	Air temperature	Relative humidity	Atmospheric pressure
In transport packing	-25 °C – 55 °C	10 % – 75 %	70 kPa – 106 kPa
Without transport packing	-5 °C – 45 °C	10 % – 75 %	70 kPa – 106 kPa

8.3 Disposal

If the product needs to be disposed of, the relevant legal regulations must be observed.

Information on the disposal of electrical and electronic devices in the European Community:

Within the European Community, the disposal of electrical devices is regulated by national regulations based on EU Directive 2012/19/EU pertaining to waste electrical and electronic equipment (WEEE).

According to these regulations, any devices supplied after August 13, 2005, in the business-to-business sphere, to which this product is assigned, may no longer be disposed of in municipal or domestic waste. To document this, they have been marked with the following marking:



Because disposal regulations may differ from one country to another within the EU, please contact your supplier if necessary.

9 Technical data

9.1 Power supply

Mains/power connection	230 V, 50 to 60 Hz 120 V, 50 to 60 Hz 100 V, 50 to 60 Hz
Current consumption	1.6 A (230 V) 3.2 A (120 V) 3.7 A (100 V)
Power consumption	max. 360 W
EMC: Noise emission (radio interference)	230 V: EN 61326-1/EN 55011 – Class A 120 V: CFR 47 FCC Part 15 – Class A 100 V: EN 61326-1/EN 55011 – Class A
EMC: Noise immunity	EN 61326-1- industrial electromagnetic environment
Overvoltage category	II
Fuses	250 V 3.15 AT HBC (230 V)
Fuses	250 V 6.3 AT (120 V)
Fuses	250 V 6.3 AT (100 V)
Degree of pollution	2

9.2 Ambient conditions

Environment:	For indoor use only.
Ambient temperature:	10 to 40 °C
Max. relative humidity:	10 to 75 %, no condensing humidity
Atmospheric pressure:	79.5 kPa – 106 kPa

9.3 Weight/dimensions

Dimensions:	Width: 290 mm (11.42 in) Depth: 480 mm (18.90 in) Height: 260 mm (10.24 in)
Weight without rotor:	21.0 kg (46.3 lb)

Rotor weights	Weight
F-24x2	797.5 g
FA-10x5	756.5 g
FA-18x2-KIT	860 g
F-32x0.2-PCR	383 g

Rotor weights	Weight
S-96x0.2	270 g

9.4 Noise level

The noise level was measured in a sound measuring room with accuracy class 1 (DIN EN ISO 3745), frontally, at a distance of 1 m from the device and at lab bench height.

Noise level:	< 54 dB(A)
--------------	------------

9.5 Application parameters

Tab. 9-1: Acceleration time and braking time according to DIN 58 970

Rotor	Acceleration time	Deceleration time
FA-24x2	15 s	15 s
FA-10x5	15 s	15 s
F-32x0.2-PCR	15 s	15 s

Run time	10 s – 9:59 h, unlimited (∞) <ul style="list-style-type: none"> • 1 min – 2 min: can be set in increments of 10 s • 2 min – 10 min: can be set in increments of 30 s • > 10 min can be set in increments of 1 min
Temperature	-10 °C – 40 °C
Speed	100 rpm – 15 060 rpm <ul style="list-style-type: none"> • 100 rpm – 5000 rpm: can be set in increments of 10 rpm • 5000 rpm – 15 060 rpm: can be set in increments of 100 rpm
Relative centrifugal force	1 rcf – 21 300 × g <ul style="list-style-type: none"> • 50 rcf – 2 990 rcf: can be set in increments of 10 rcf • 1 rcf – 21 300 × g: can be set in increments of 100 rcf
Maximum load	Fixed-angle rotor: 10 × 5 mL Swing-bucket rotors: 96 × 0.2 mL
Maximum kinetic energy	4136 J
Permitted density of the material for centrifuging (at maximum <i>g</i> -force (rcf) or rotational speed (rpm) and maximum load)	1.2 g/mL
Inspection obligation in Germany	no

9.6 Service life of accessories



CAUTION! Danger due to material fatigue.

If the service life is exceeded, it cannot be guaranteed that the material of the rotors and the accessories will withstand the stresses during centrifugation.

- ▶ Do not use accessories that have exceeded their maximum service life.

Eppendorf states the maximum service life of rotors and accessories in cycles and years. The number of cycles is decisive. If determination of the number of cycles is not possible, the service life in years applies.

Each centrifugation run during which the rotor is accelerated and braked is counted as a cycle, independent of the speed and the duration of the centrifugation run.

Unless stated otherwise (in the manual of the centrifuge, indications of the number of cycles on the rotor, in the instructions for use of the rotor), all other rotors and rotor lids can be used over the entire service life of the centrifuge if the following prerequisites are met:

- proper use
- recommended maintenance
- undamaged condition

Accessories	Maximum service life after first initial setup
Rotor lid of polycarbonate (PC), polypropylene (PP) or polyetherimide (PEI)	3 years
Aerosol-tight rotor lids with exchangeable seal (e.g., QuickLock rotor lids)	3 years (replace seals every 50 autoclaving cycles)
Non-aerosol-tight rotor lids	3 years
Adapter	1 year

The date of manufacture is stamped on the rotors and buckets in the format *03/15* or *03/2015* (= March 2015). On the inside of the plastic-rotor lids and aerosol-tight caps, the date of manufacture is stamped in the form of a clock ⌚.

10 Rotors for the Centrifuge 5425 R



Eppendorf centrifuges may only be operated with rotors that are intended for use with the corresponding centrifuge.









- ▶ Only use rotors that are intended for use with the corresponding centrifuge.

Please note the manufacturer's information on the centrifugation resistance of the sample tubes used (maximum g -force).

10.1 Rotor FA-24x2 and rotor FA-24x2-PTFE

Aerosol-tight fixed-angle rotor for 24 tubes









	Max. <i>g</i> force:	21 300 × <i>g</i>
	Max. rotational speed:	15 060 rpm
Rotor FA-24x2 FA-24x2-PTFE	Max. load (adapter, tube and contents):	24 × 3.75 <i>g</i>

Tube	Tube Capacity	Adapter	Bottom shape Diameter	Max. <i>g</i> -force
				Max. rotational speed
				Radius
	PCR tube 0.2 mL 1/24	 5425 715.005	conical Ø 6 mm	15975 × <i>g</i> 15 060 rpm 6.3 cm
	Micro test tube 0.4 mL 1/24	 5425 717.008	conical Ø 6 mm	21 300 × <i>g</i> 15 060 rpm 8.4 cm
	Micro test tube 0.5 mL 1/24	 5425 716.001	– Ø 8 mm	18510 × <i>g</i> 15 060 rpm 7.3 cm
	Microtainers 0.6 mL 1/24	 5425 716.001	– Ø 8 mm	21 300 × <i>g</i> 15 060 rpm 8.4 cm
	Micro test tube 1.5 mL/2 mL –/24	–	conical Ø 11 mm	21 300 × <i>g</i> 15 060 rpm 8.4 cm

10.2 Rotor FA-18x2 kit

Aerosol-tight fixed-angle rotor for 18 tubes







	Max. <i>g</i> -force:	18565 × <i>g</i>
	Max. rotational speed:	15 060 rpm
Rotor FA-18x2 kit	Max. load (adapter, tube and contents):	18 × 3.75 g

Tube	Tube Capacity	Adapter	Bottom shape Diameter	Max. <i>g</i> -force
				Max. rotational speed
				Radius
	PCR tube 0.2 mL 1/18	 5425 715.005	Conical Ø 6 mm	13211 × <i>g</i> 15 060 rpm 5.2 cm
	Micro test tube 0.4 mL 1/18	 5425 717.008	Conical Ø 6 mm	18565 × <i>g</i> 15 060 rpm 7.3 cm
	Micro test tube 0.5 mL 1/18	 5425 716.001	– Ø 8 mm	15746 × <i>g</i> 15 060 rpm 6.2 cm
	Microtainers 0.6 mL 1/18	 5425 716.001	– Ø 8 mm	18565 × <i>g</i> 15 060 rpm 7.3 cm
	Micro test tube 1.5 mL/2 mL –/18	–	Conical Ø 11 mm	18565 × <i>g</i> 15 060 rpm 7.3 cm

10.3 Rotor FA-10x5

Aerosol-tight fixed-angle rotor for 10 tubes



	Max. <i>g</i> -force:	21300 × <i>g</i>
	Max. speed:	15060 rpm
Rotor FA-10x5	Max. load (adapter, tube and contents):	10 × 10.0 g

Tube	Tube Capacity Tubes per adapter/ rotor	Adapter Order no. (international)	Bottom shape Diameter	Max. <i>g</i> -force Max. speed Radius
	HPLC vial 1/10	 5820 770.007	Ø 11 mm	16258 × <i>g</i> 15060 rpm 6.4 cm
	Cryogenic tube 1.0 mL/2.0 mL 1/10	 5820 769.009	Ø 13 mm	18540 × <i>g</i> 15060 rpm 7.3 cm
	Micro test tube 1.5 mL/2.0 mL 1/10	 5820 768.002	Open Ø 11 mm	17779 × <i>g</i> 15060 rpm 7.0 cm
	Eppendorf Tubes 5 mL -/10	–	Conical Ø 17 mm	21300 × <i>g</i> 15060 rpm 8.4 cm

10.4 Rotor F-32x0.2-PCR

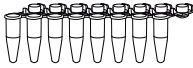

Fixed-angle rotor for PCR strips and PCR tubes

	Max. <i>g</i> -force:	18257 × <i>g</i>
	Max. speed:	15060 rpm
Rotor F-32x0.2-PCR	Max. load (tube and contents):	32 × 3.5 g

Tube	Tube Capacity Vessels per rotor	Bottom shape Diameter	Max. <i>g</i>-force
			Max. speed
			Radius
	PCR strips 8 × 0.2 mL or 5 × 0.2 mL 4 × 8 or 4 × 5	Conical Ø 6 mm	18257 × <i>g</i> 15060 rpm 7.2 cm
	PCR tube 0.2 mL 32	Conical Ø 6 mm	18257 × <i>g</i> 15060 rpm 7.2 cm

Rotors for the Centrifuge 5425 RCentrifuge 5425 R
English (EN)**10.5 Rotor S-96x0.2**

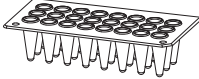
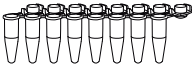
Swing-bucket rotor for PCR strips, PCR tubes and divisible Eppendorf twin.tec PCR Plate 96, unskirted (4 × ¼)

	Max. <i>g</i> force:	3217 × <i>g</i>
	Max. rotational speed:	6000 rpm
Rotor S-96x0.2	Max. load per bucket (tubes and contents):	104 g
Tube	Tube Capacity Quantity per rotor	Max. <i>g</i>-force Max. rotational speed Radius
	Eppendorf twin.tec PCR Plate 96, unskirted, divisible 4 × 24 wells 4 × ¼	3217 × <i>g</i> 6000 rpm 8.0 cm
	PCR strips 8 × 0.2 mL or 5 × 0.2 mL 12 × 8 or 12 × 5	3217 × <i>g</i> 6000 rpm 8.0 cm
	PCR tube 0.2 mL 96	3217 × <i>g</i> 6000 rpm 8.0 cm

11 Ordering information

Order no. (International)	Order no. (North America)	Description
5495 500.006	5495500006	Rotor FA-24x2 aerosol-tight, 24 × 1.5/2 mL tubes incl. aerosol-tight rotor lid, Centrifuge 5425
5495 501.002	5495501002	Rotor lid FA-24x2 aerosol-tight, aluminum
5495 503.005	5495503005	Rotor FA-24x2-PTFE aerosol-tight, 24 × 1.5/2 mL tubes incl. aerosol-tight rotor lid, Centrifuge 5425
5495 504.001	5495504001	Rotor lid FA-24x2-PTFE aerosol-tight, aluminum
5495 505.008	5495505008	Rotor FA-10x5 aerosol-tight, 10 × 5 mL tubes incl. aerosol-tight rotor lid, Centrifuge 5425
5495 506.004	5495506004	Rotor lid FA-10x5 aerosol-tight, aluminum
5495 508.007	5495508007	Rotor FA-18x2-KIT aerosol-tight, 18 × 1.5/2 mL tubes incl. aerosol-tight rotor lid, Centrifuge 5425
5495 509.003	5495509003	Rotor lid FA-18x2-KIT aerosol-tight, aluminum
5495 502.009 5495 507.000	5495502009 5495507000	Seal for rotor lid FA-24x2-PTFE (Centrifuge 5425) FA-10x5 (Centrifuge 5425)
5495 510.001	5495510001	Rotor F-32x0.2-PCR 32 × 0.2 mL PCR tubes or 4 × 8 PCR tube strips incl. rotor lid, Centrifuge 5425
5495 511.008	5495511008	Rotor lid F-32x0.2-PCR aluminum
5495 512.004	5495512004	Rotor S-96x0.2-PCR 96 × 0.2 mL PCR tubes or 12 × 8 PCR tube strips incl. buckets
5495 513.000	5495513000	Bucket S-96x0.2-PCR 2 pieces
5424 852.122 5424 852.130	950004267 950004241	Fuse 3,15 A T (230 V), set of 2 6,3 A T (120 V/100 V), set of 2

Ordering information

Centrifuge 5425 R
English (EN)

Declaration of Conformity

The product named below fulfills the requirements of directives and standards listed. In the case of unauthorized modifications to the product or an unintended use this declaration becomes invalid. This declaration of conformity is issued under the sole responsibility of the manufacturer.

Product name:

Centrifuge 5425 R

including components

Product type:

Centrifuge

Relevant directives / standards:

2006/42/EC: EN ISO 12100, EN 378-2, EN 61010-2-120

2014/35/EU: EN 61010-1, EN 61010-2-011, EN 61010-2-020, IEC 61010-1, IEC 61010-2-011,
IEC 61010-2-020, IEC 61010-2-101, IEC 61010-2-120

UL 61010-1, UL 61010-2-020

CAN/CSA C22.2 No. 61010-1, CAN/CSA C22.2 No. 61010-2-020

2014/30/EU: EN 61326-1, IEC 61326-1

47 CFR FCC part 15

2011/65/EU: EN 50581

Person authorized to compile
the technical file acc. to 2006/42/EC: Dr. Marlene Jentzsch
Head of Business Unit Centrifugation
Eppendorf AG

Hamburg, January 22, 2020



Dr. Wilhelm Plüster
Management Board



Dr. Marlene Jentzsch
Head of Business Unit
Centrifugation

Your local distributor: www.eppendorf.com/contact
Eppendorf AG · Barkhausenweg 1 · 22339 Hamburg · Germany
eppendorf@eppendorf.com

Eppendorf® and the Eppendorf Brand Design are registered trademarks of Eppendorf AG, Germany.
All rights reserved, incl. graphics and pictures. Copyright ©2020 by Eppendorf AG.

www.eppendorf.com

ISO
9001
Certified

ISO 13485
Certified

ISO 14001
Certified



Certificate of Containment Testing

Containment Testing of Rotor FA-24x2* in an Eppendorf 5425 Bench Top Centrifuge

Report No. 17/016 A

Report Prepared For: Eppendorf AG, Hamburg, Germany

Issue Date: 15 August 2017

Test Summary

Rotor FA-24x2* was containment tested in an Eppendorf 5425 bench top centrifuge, using Annex AA of IEC 61010-2-020:2016 (3rd Ed.). The sealed rotor was shown to contain a spill.

Report Written By

Name: Ms Anna Moy

Title: Biosafety Scientist

Report Authorised By

Name: Mrs Sara Speight

Title: Senior Biosafety Scientist

Please be aware that the use of the Royal Coat of Arms is highly restricted and cannot be copied. Please do not put the PHE logo on your website or use our name to endorse your products. Any reference to PHE needs to be approved by us before it can be used.



Public Health
England

Public Health England
National Infection Service
Porton Down
Salisbury
Wiltshire
SP4 OJG

Certificate of Containment Testing

Containment Testing of Rotor FA-24x2-PTFE* in an Eppendorf 5425 Bench Top Centrifuge

Report No. 17/016 B

Report Prepared For: Eppendorf AG, Hamburg, Germany

Issue Date: 15 August 2017

Test Summary

Rotor FA-24x2-PTFE* was containment tested in an Eppendorf 5425 bench top centrifuge, using Annex AA of IEC 61010-2-020:2016 (3rd Ed.). The sealed rotor was shown to contain a spill.

Report Written By

Name: Ms Anna Moy

Title: Biosafety Scientist

Report Authorised By

Name: Mrs Sara Speight

Title: Senior Biosafety Scientist

Please be aware that the use of the Royal Coat of Arms is highly restricted and cannot be copied. Please do not put the PHE logo on your website or use our name to endorse your products. Any reference to PHE needs to be approved by us before it can be used.

* Part no. will form part of catalogue number 5495 503.005



Public Health
England

Public Health England
National Infection Service
Porton Down
Salisbury
Wiltshire
SP4 OJG

Certificate of Containment Testing

Containment Testing of Rotor FA-10x5* in an Eppendorf 5425 Bench Top Centrifuge

Report No. 17/016 C

Report Prepared For: Eppendorf AG, Hamburg, Germany

Issue Date: 15 August 2017

Test Summary

Rotor FA-10x5* was containment tested in an Eppendorf 5425 bench top centrifuge, using Annex AA of IEC 61010-2-020:2016 (3rd Ed.). The sealed rotor was shown to contain a spill.

Report Written By

Name: Ms Anna Moy

Title: Biosafety Scientist

Report Authorised By

Name: Mrs Sara Speight

Title: Senior Biosafety Scientist

Please be aware that the use of the Royal Coat of Arms is highly restricted and cannot be copied. Please do not put the PHE logo on your website or use our name to endorse your products. Any reference to PHE needs to be approved by us before it can be used.

* Part no. will form part of catalogue number 5495 505.008



Certificate of Containment Testing

Containment Testing of Rotor FA-18x2-KIT* in an Eppendorf 5425 Bench Top Centrifuge

Report No. 17/016 D

Report Prepared For: Eppendorf AG, Hamburg, Germany

Issue Date: 15 August 2017

Test Summary

Rotor FA-18x2-KIT* was containment tested in an Eppendorf 5425 bench top centrifuge, using Annex AA of IEC 61010-2-020:2016 (3rd Ed.). The sealed rotor was shown to contain a spill.

Report Written By

Name: Ms Anna Moy

Title: Biosafety Scientist

Report Authorised By

Name: Mrs Sara Speight

Title: Senior Biosafety Scientist

Please be aware that the use of the Royal Coat of Arms is highly restricted and cannot be copied. Please do not put the PHE logo on your website or use our name to endorse your products. Any reference to PHE needs to be approved by us before it can be used.

Evaluate Your Manual

Give us your feedback.
www.eppendorf.com/manualfeedback