

Register your instrument!
www.eppendorf.com/myeppendorf



Centrifuge 5425

Original instructions

Copyright ©2018 Eppendorf AG, Germany. All rights reserved, including graphics and images. No part of this publication may be reproduced without the prior permission of the copyright owner.

Microtainer® is a registered trademark of Becton Dickinson, USA.

Eppendorf® and the Eppendorf Brand Design are registered trademarks of Eppendorf AG, Germany.

Registered trademarks and protected trademarks are not marked in all cases with ® or ™ in this manual.

Table of contents

1	Operating instructions	7
1.1	Using this manual	7
1.2	Danger symbols and danger levels	7
1.2.1	Danger symbols	7
1.2.2	Danger levels	7
1.3	Symbols used	7
1.4	Abbreviations used	8
2	Safety	9
2.1	Intended use	9
2.2	User profile	9
2.3	Information on product liability	9
2.4	Application limits	9
2.4.1	Declaration concerning the ATEX directive (2014/34/EU)	9
2.5	Warnings for intended use	10
2.5.1	Personal injury or damage to the equipment	10
2.5.2	Incorrect handling of the centrifuge	11
2.5.3	Incorrect handling of the rotors	12
2.5.4	Extreme strain on the centrifuging tubes	13
2.6	Safety instructions on device and accessories	14
3	Product description	15
3.1	Product overview	15
3.2	Delivery package	16
3.3	Features	16
3.4	Name plate	17
4	Installation	19
4.1	Selecting the location	19
4.2	Preparing installation	20
4.3	Installing the instrument	20
5	Operation	21
5.1	Operating controls	21
5.2	Menu	23
5.2.1	Navigating in the menu	23
5.2.2	Menu structure	24
5.3	Switching on the centrifuge	25
5.4	Replacing the rotor	25
5.4.1	Inserting the rotor	25
5.4.2	Removing the rotor	25
5.4.3	Triggering rotor detection	26
5.5	Preparing for centrifugation	27
5.5.1	Loading the rotor	27
5.5.2	Closing the rotor lid	28
5.5.3	Closing the QuickLock rotor lid	29
5.6	Centrifugation	30

Table of contentsCentrifuge 5425
English (EN)

5.6.1	Centrifuging with preset time	30
5.6.2	End of centrifugation	31
5.6.3	Centrifuging in continuous operation	31
5.6.4	Short run centrifugation	31
5.6.5	Adjusting the radius: setting the rotor and the tube volume	32
5.6.6	Setting the acceleration ramp and braking ramp	32
5.6.7	Setting the start for time counting (ATSET)	32
5.6.8	Setting the start of the centrifugation run (TIMER)	33
5.7	Aerosol-tight centrifugation	33
5.7.1	Aerosol-tight centrifugation in a fixed-angle rotor	34
5.8	Switching off the centrifuge	34
6	Programs	35
6.1	Creating a new program	35
6.1.1	Saving a program	35
6.1.2	Adding write protection to a program.	35
6.2	Loading a saved program	36
6.2.1	Loading program prog 1 to prog 3	36
6.3	Overwriting programs	36
6.3.1	Removing the write protection of programs	36
6.3.2	Editing programs.	36
7	Device settings	37
7.1	Setting alarms	37
7.1.1	Activating the alarm	37
7.1.2	Deactivating the alarm	37
7.2	Sleep mode	37
7.2.1	Activating the sleep mode.	37
7.2.2	Deactivating the sleep mode.	38
7.3	Automatic lid opening.	38
7.3.1	Activating automatic lid opening	38
7.3.2	Deactivating automatic lid opening	38
8	Maintenance	39
8.1	Service.	39
8.2	Preparing cleaning/disinfection	39
8.3	Cleaning/disinfection	40
8.3.1	Cleaning and disinfecting the device	41
8.3.2	Disinfecting and cleaning the rotor.	41
8.3.3	Cleaning and disinfecting the rotor lid	42
8.4	Cleaning glass breakage	43
8.5	Replacing fuses.	44
8.6	Decontamination before shipment	44
9	Troubleshooting	45
9.1	General errors	45
9.2	Error messages	46
9.3	Emergency release	47

10	Transport, storage and disposal	49
10.1	Transport	49
10.2	Storage	49
10.3	Disposal	49
11	Technical data	51
11.1	Power supply	51
11.2	Ambient conditions	51
11.3	Weight/dimensions	51
11.4	Noise level	52
11.5	Application parameters	52
11.6	Acceleration and deceleration times	53
11.7	Service life for accessories	53
12	Rotors for the Centrifuge 5425	55
12.1	Rotor FA-24x2 and rotor FA-24x2-PTFE	55
12.2	Rotor FA-18x2 kit	56
12.3	Rotor FA-10x5	57
12.4	Rotor F-32x0.2-PCR	58
12.5	Rotor S-96x0.2	59
13	Ordering information	61
	Certificates	63

Table of contents

Centrifuge 5425

English (EN)

1 Operating instructions







1.1 Using this manual

- ▶ Read this operating manual thoroughly before using the device for the first time. Also observe the instructions for use of the accessories.
- ▶ This operating manual is part of the product. It must always be kept easily accessible.
- ▶ Enclose this operating manual when transferring the device to third parties.
- ▶ You will find the current version of the operating manual for all available languages on our website at www.eppendorf.com/manuals.

1.2 Danger symbols and danger levels

1.2.1 Danger symbols

The safety instructions in this manual have the following danger symbols and danger levels:

	Biohazard		Explosive substances
	Electric shock		Risk of crushing
	Hazard point		Material damage

1.2.2 Danger levels

DANGER	<i>Will</i> lead to severe injuries or death.
WARNING	<i>May</i> lead to severe injuries or death.
CAUTION	May lead to light to moderate injuries.
NOTICE	May lead to material damage.

1.3 Symbols used

Depiction	Meaning
1. 2.	Actions in the specified order
▶	Actions without a specified order
•	List
<i>Text</i>	Display or software texts
	Additional information

1.4 Abbreviations used

PCR

Polymerase Chain Reaction – PCR

PTFE

Polytetrafluorethylene

rcfRelative centrifugal force: *g*-force in m/s^2 **rpm**

Revolutions per minute

UV

Ultraviolet radiation

2 Safety

2.1 Intended use

The Centrifuge 5425 is used for the separation of aqueous solutions and suspensions of different densities in approved sample tubes.

The Centrifuge 5425 is exclusively intended for use indoors. All country-specific safety requirements for operating electrical equipment in the laboratory must be observed.

2.2 User profile

The device and accessories may only be operated by trained and skilled personnel.

Before using the device, read the operating manual carefully and familiarize yourself with the device's mode of operation.

2.3 Information on product liability

In the following cases, the designated protection of the device may be compromised. Liability for any resulting property damage or personal injury is then transferred to the operator:

- The device is not used in accordance with the operating manual.
- The device is used outside of its intended use.
- The device is used with accessories or consumables which are not recommended by Eppendorf.
- The device is maintained or repaired by individuals not authorized by Eppendorf.
- The user makes unauthorized changes to the device.

2.4 Application limits

2.4.1 Declaration concerning the ATEX directive (2014/34/EU)



DANGER! Risk of explosion.

- ▶ Do not operate the device in areas where work is completed with explosive substances.
 - ▶ Do not use this device to process any explosive or highly reactive substances.
 - ▶ Do not use this device to process any substances which could create an explosive atmosphere.
-

Due to its design and the environmental conditions inside the device, the Centrifuge 5425 is not suitable for use in a potentially explosive atmosphere.

The device may only be used in a safe environment, such as in the open environment of a ventilated laboratory or a fume hood. The use of substances that may contribute to a potentially explosive atmosphere is not permitted. The final decision on the risks associated with the use of such substances lies with the user.

2.5 Warnings for intended use

2.5.1 Personal injury or damage to the equipment



WARNING! Electric shock due to damage to device or mains/power cord.

- ▶ Only switch on the device if the device and the mains/power cord are undamaged.
- ▶ Only use devices that have been properly installed or repaired.
- ▶ In case of danger, disconnect the device from the mains supply. Disconnect the mains/power plug from the device or the earth/grounded socket. Use the isolating device intended for this purpose (e.g., the emergency switch in the laboratory).



WARNING! Lethal voltages inside the device.

Touching parts which are under high voltage may cause an electric shock. An electric shock injures the heart and causes respiratory paralysis.

- ▶ Ensure that the housing is closed and undamaged.
 - ▶ Do not remove the housing.
 - ▶ Ensure that no liquid can penetrate into the device.
- Only authorized service personnel may open the device.



WARNING! Risk from incorrect voltage supply.

- ▶ Only connect the device to voltage sources which correspond with the electrical requirements on the name plate.
- ▶ Only use sockets with a protective earth conductor.
- ▶ Only use the mains/power cord supplied.



WARNING! Damage to health due to infectious liquids and pathogenic germs.

- ▶ When handling infectious liquids and pathogenic germs, observe the national regulations, the biological security level of your laboratory, the safety data sheets, and the manufacturer's application notes.
- ▶ Wear your personal protective equipment.
- ▶ Consult the "Laboratory Biosafety Manual" (source: World Health Organization, Laboratory Biosafety Manual, in its respective current valid version).



WARNING! Risk of injury when opening or closing the centrifuge lid.

There is a risk of crushing your fingers when opening or closing the centrifuge lid.

- ▶ When opening or closing the centrifuge lid, do not reach between the lid and device or into the latching mechanism of the lid.
- ▶ Always open the centrifuge lid completely to prevent it from falling.



WARNING! Risk of injury from chemically or mechanically damaged accessories.

Even minor scratches and cracks can lead to serious internal material damage.

- ▶ Protect all accessory parts from mechanical damage.
- ▶ Inspect the accessories for damage before each use. Replace any damaged accessories.
- ▶ Do not use any accessories whose maximum service life has been exceeded.



CAUTION! Poor safety due to incorrect accessories and spare parts.

The use of accessories and spare parts other than those recommended by Eppendorf may impair the safety, functioning and precision of the device. Eppendorf cannot be held liable or accept any liability for damage resulting from the use of incorrect or non-recommended accessories and spare parts or from the improper use of such equipment.

- ▶ Only use accessories and original spare parts recommended by Eppendorf.



NOTICE! Damage to device due to spilled liquids.

1. Switch off the device.
2. Disconnect the device from the mains/power supply.
3. Carefully clean the device and the accessories in accordance with the cleaning and disinfection instructions in the operating manual.
4. If a different cleaning and disinfecting method is to be used, contact Eppendorf AG to ensure that the intended method will not damage the device.



NOTICE! Damage to electronic components due to condensation.

Condensate can form in the device after it has been moved from a cool environment to a warmer environment.

- ▶ After installing the device, wait for at least 4 h. Only then connect the device to the mains/power line.

2.5.2 Incorrect handling of the centrifuge



NOTICE! Damage from knocking against or moving the device during operation.

If the rotor bangs against the rotor chamber wall, it will cause considerable damage to the device and rotor.

- ▶ Do not move or knock against the device during operation.

2.5.3 Incorrect handling of the rotors



WARNING! Risk of injury from improperly attached rotors and rotor lids.

- ▶ Only centrifuge with rotor and rotor lid firmly tightened.
 - ▶ If there are any unusual noises when the centrifuge is started up, the rotor or rotor lid may not be properly attached. Immediately press the **start/stop** key to stop centrifuging.
-



CAUTION! Risk of injury due to asymmetric loading of a rotor.

- ▶ Load rotors symmetrically with identical tubes.
 - ▶ Only load adapters with suitable tubes.
 - ▶ Always use the same type of tubes (weight, material/density and volume).
 - ▶ Check symmetric loading by balancing the adapters and tubes used with scales.
-



CAUTION! Risk of injury from overloaded rotor.

The centrifuge is designed for the centrifugation of material with a maximum density of 1.2 g/mL at maximum speed and filling volume and/or load.

- ▶ Do not exceed the maximum load of the rotor.
-



NOTICE! Damage to rotors from aggressive chemicals.

Rotors are high-quality components which withstand extreme stresses. This stability can be impaired by aggressive chemicals.

- ▶ Avoid using aggressive chemicals such as strong and weak alkalis, strong acids, solutions with mercury ions, copper ions and other heavy metal ions, halogenated hydrocarbons, concentrated saline solutions and phenol.
 - ▶ If the rotor is contaminated by aggressive chemicals, clean it immediately using a neutral cleaning agent. Clean the rotor bores in particular.
 - ▶ Due to the manufacturing process, color variations may occur on PTFE coated rotors. These color variations do not affect the service life or resistance to chemicals.
-

2.5.4 Extreme strain on the centrifuging tubes



CAUTION! Risk of injury from overloaded tubes.

- ▶ Note the loading limits specified by the tube manufacturer.
- ▶ Only use tubes which are approved by the manufacturer for the required *g*-forces (rcf).



NOTICE! Risk from damaged tubes.

Damaged tubes must not be used, as this could cause further damage to the device and the accessories and loss of the samples.

- ▶ Before use, visually check all of the tubes for damage.



NOTICE! Risk from open tube lids.

Open tube lids can break off during centrifugation and damage the rotor and the centrifuge.

- ▶ Carefully seal all tube lids before centrifuging.

Exception: Note the information on the centrifugation of spin columns in the rotor FA-18x2-KIT.



NOTICE! Hazard to plastic tubes from organic solvents.

The density of plastic tubes is reduced when organic solvents (e.g., phenol, chloroform) are used, i.e. the tubes could become damaged.

- ▶ Observe the manufacturer's specifications for chemical resistance of the tubes.





NOTICE! Micro test tubes heat up.

In uncooled centrifuges, the temperature in the rotor chamber, rotor and sample can increase to above 40 °C, depending on the cycle time, *g*-force (rcf)/speed and ambient temperature.

- ▶ Please note that this will reduce the centrifugation stability of the micro test tubes.
 - ▶ Please note the temperature resistance of the samples.
-

2.6 Safety instructions on device and accessories

Depiction	Meaning	Location
	CAUTION <ul style="list-style-type: none">▶ Observe the safety instructions in the operating manual.	Right side of the device
	<ul style="list-style-type: none">▶ Observe operating manual.	Right side of the device
	Warning of biological risks when handling infectious liquids or pathogenic germs.	Aerosol-tight fixed-angle rotors: Rotor lid

3 Product description

3.1 Product overview



Abb. 3-1: Centrifuge 5425: Front and side view

- | | |
|--|--|
| 1 Centrifuge lid | 6 Fuse holder |
| 2 Monitoring glass
For visual control during rotor stop or speed check using a stroboscope | 7 Mains/power switch
Switch for switching the centrifuge on and off. |
| 3 Control panel
Display and keys for operating the centrifuge | 8 Name plate |
| 4 Interface for software updates
Only for authorized service personnel | 9 Emergency release |
| 5 Mains/power cord socket
Socket for the supplied mains/power cord. | |

Product description

Centrifuge 5425
English (EN)

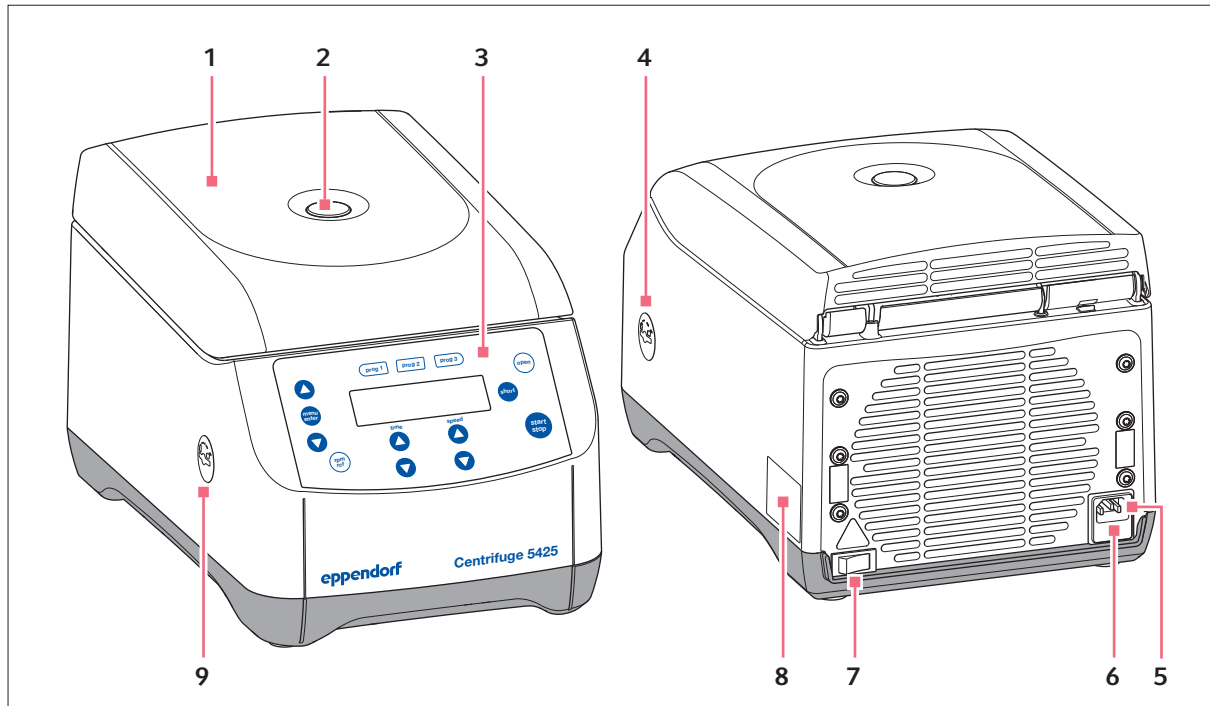
3.2 Delivery package

1	Centrifuge 5425 see <i>Ordering information</i> chapter for the corresponding device version, equipment and order numbers
1	Rotor key
1	Mains/power cord
1	Operating manual
1	Set of fuses



- ▶ Check the delivery for completeness.
- ▶ Inspect all items for damage that may have occurred during delivery.
- ▶ To safely transport and store the device, keep the transport box and packing material.

3.3 Features

The versatile Centrifuge 5425 has a capacity of up to 10 × 5 mL and reaches a maximum of 21330 × *g* or 15060 rpm.

You can select from 6 different rotors to centrifuge the following tubes for various applications:

- Tubes (0.2 mL to 5.0 mL)
- PCR strips
- Microtainers
- Spin columns
- Cryogenic tubes

The centrifuge has 3 program keys for direct selection of user-defined settings and more than 10 different acceleration and braking ramps.

3.4 Name plate







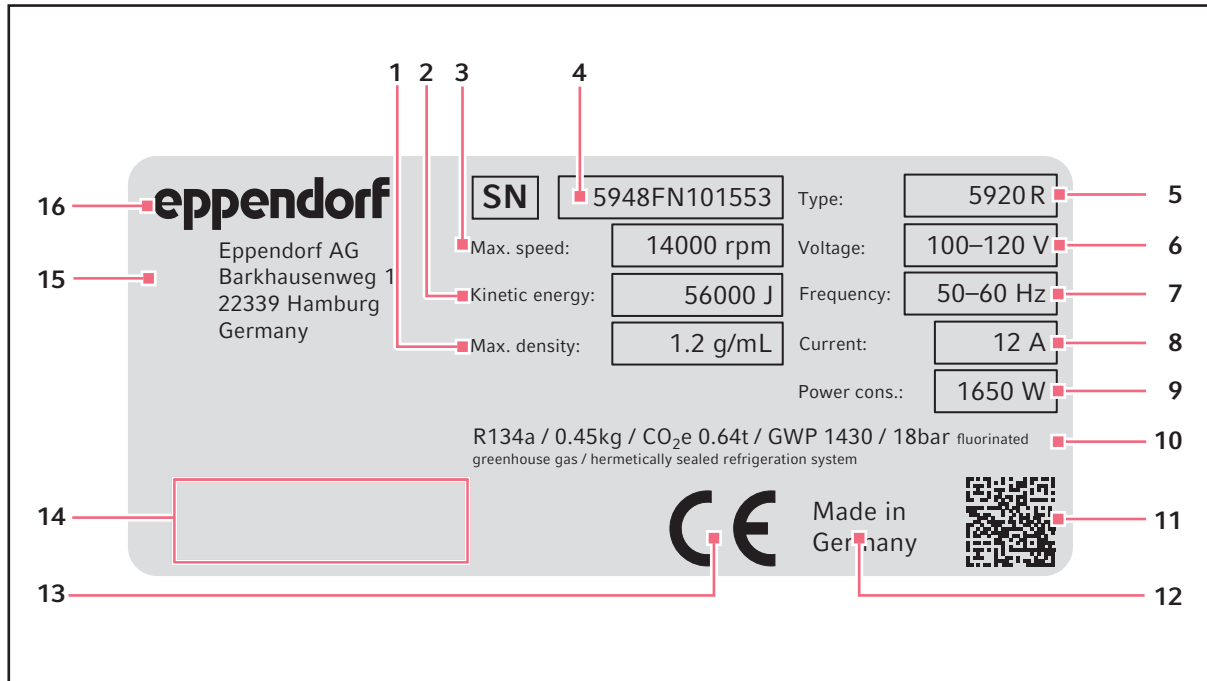

Abb. 3-2: Eppendorf AG device identification (example)

- | | |
|---|--|
| 1 Maximum density of the material for centrifuging | 9 Power consumption |
| 2 Maximum kinetic energy | 10 Information on the refrigerant (refrigerated centrifuges only) |
| 3 Maximum speed | 11 Data matrix code for serial number |
| 4 Serial number | 12 Designation of origin |
| 5 Product name | 13 CE marking |
| 6 Permitted voltage | 14 Certification marks and symbols (device-specific) |
| 7 Permitted frequency | 15 Address of manufacturer |
| 8 Current consumption | 16 Manufacturer |

Product description

Centrifuge 5425
English (EN)

Tab. 3-1: Certification marks and symbols (device-specific)

Symbol/Approval mark	Meaning
	Serial number
	Symbol for waste electrical and electronic equipment (WEEE) according to EU Directive 2012/19/EU, European Community
	UL mark: declaration of conformity, USA
	Conformity mark for electromagnetic compatibility according to the Federal Communications Commission, USA
	"China RoHS" conformity mark (Requirements for Concentration Limits for Certain Hazardous Substances in Electronic Information Products SJ/T 11363-2006), People's Republic of China

4 Installation

4.1 Selecting the location



WARNING! Risk from incorrect voltage supply.

- ▶ Only connect the device to voltage sources which correspond with the electrical requirements on the name plate.
 - ▶ Only use sockets with a protective earth conductor.
 - ▶ Only use the mains/power cord supplied.
-



NOTICE! If an error occurs, objects in the immediate vicinity of the device will be damaged.

- ▶ In accordance with the recommendations of EN 61010-2-020, leave a safety clearance of **30 cm** around the device during operation.
 - ▶ Please remove all materials and objects from this area.
-



NOTICE! Damage from overheating.

- ▶ Do not place the device near heat sources (e.g., heating, drying cabinet).
 - ▶ Do not expose the device to direct sunlight.
 - ▶ Ensure unobstructed air circulation. Maintain a clearance of at least 30 cm (11.8 in) around all ventilation gaps.
-



Mains/power connection of centrifuges: Operation of the centrifuge is only allowed using building facilities corresponding to applicable national regulations and standards. In particular it must be made sure that lines and assemblies upstream of the device-internal protection are protected against inadmissible loads. This can be ensured using additional circuit breakers or other suitable fuse elements in the building facility.



The mains/power switch and cutting unit of the mains/power line must be easily accessible during operation (e.g., residual current circuit breaker).

Select the location of the device according to the following criteria:

- Mains/power connection in accordance with the name plate
- Minimum distance to other devices and walls: 30 cm (11.8 in)
- Resonance free table with horizontal even work surface
- The surrounding area must be well ventilated.
- The location is protected against direct sunlight.

4.2 Preparing installation

The weight of the centrifuge is 15.6 kg (34.39 lb).

Unpacking the centrifuge

1. Open the packaging box.
2. Remove accessories.
3. Lift the centrifuge out of the box.
4. Place the centrifuge on a suitable lab bench.
5. Remove the plastic sleeve.
6. Turn the rotor nut **counterclockwise** using the supplied rotor key.
7. Lift the rotor out vertically.
8. Remove the transport securing device.

4.3 Installing the instrument

Prerequisites

The device is on a suitable lab bench.



WARNING! Risk from incorrect voltage supply.

- ▶ Only connect the device to voltage sources which correspond with the electrical requirements on the name plate.
- ▶ Only use sockets with a protective earth conductor.
- ▶ Only use the mains/power cord supplied.



NOTICE! Damage to electronic components due to condensation.

Condensate can form in the device after it has been moved from a cool environment to a warmer environment.

- ▶ After installing the device, wait for at least 4 h. Only then connect the device to the mains/power line.

-
1. Let the device warm up to ambient temperature.
 2. Connect the centrifuge to the mains/power line and switch it on at the mains/power switch.
 - The **open** key lights up.
 - The display is active.
 - The lid opens.

5 Operation

5.1 Operating controls

The Centrifuge 5425 is available in two versions: with keypad (arrow keys) or with rotary knobs. This operating manual describes the operation of the centrifuge with keypad. The centrifuge with rotary knobs is operated in the same manner.



Abb. 5-1: Operating controls Centrifuge 5425

1 Program keys

Press the program key: Loading programs
Keep the program key pressed for 2 s: Save current parameters

2 Display

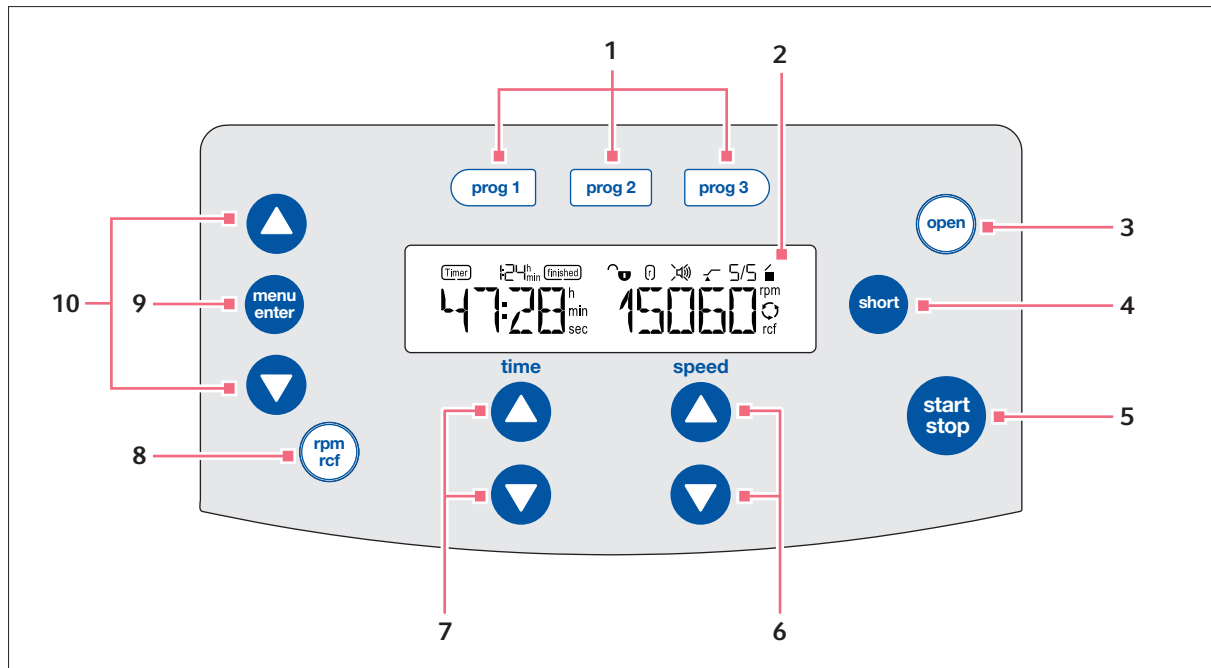
3 open key

Release the lid

4 short key

Short run centrifugation

5 start/stop key

Start and stop centrifugation

6 speed arrow keys

Set the speed of centrifugation
Keep the arrow key pressed: quick setting

7 time arrow keys

Set the centrifugation time
Keep the arrow key pressed: quick setting

8 rpm/rcf key

Switch display of centrifugation speed (rpm or rcf)

9 menu/enter key

Open the menu
Confirm your selection

10 Menu arrow keys

Navigating in the menu











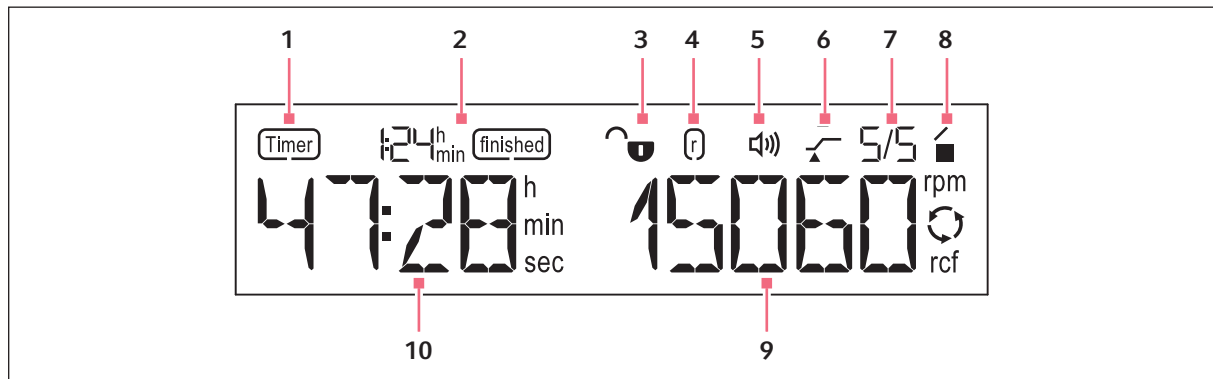

Abb. 5-2: Display Centrifuge 5425

- | | |
|--|--|
| <p>1 Timer function
Timer set: delayed start of the centrifugation run</p> <p>2 finished function
time elapsed since the end of the centrifugation run</p> <p>3 Program lock
 <ul style="list-style-type: none"> Program lock activated: program cannot be overwritten. Program lock not activated: program settings can be changed and overwritten. </p> <p>4 Radius</p> <p>5 Speaker
 <ul style="list-style-type: none"> Speaker switched on. Speaker switched off. </p> | <p>6 At set rpm function
 <ul style="list-style-type: none"> : the set run time will be counted down when 95 % of the specified <i>g</i>-force (rcf) or speed (rpm) has been reached. : Start of time counting immediately. </p> <p>7 Ramps
Acceleration ramp and braking ramp, stage 0 to 9</p> <p>8 Centrifuge status
 <ul style="list-style-type: none"> centrifuge lid unlocked. centrifuge lid locked. (flashing): centrifuging in progress. </p> <p>9 <i>g</i>-force (rcf) or speed (rpm)
Actual value</p> <p>10 Centrifugation time</p> |
|--|--|

5.2 Menu

5.2.1 Navigating in the menu





1.		To open the menu, press the menu/enter key.
2.	  	Select the menu item with the menu arrow keys.
3.		To confirm your selection, press the menu/enter key.
4.	  	Change the settings with the menu arrow keys.
5.		To confirm the changed setting, press the menu/enter key.

► In order to leave a menu level, select *BACK* and confirm with the **menu/enter** key.



When the lid is open, the menu can also be left using the **start/stop** key.

5.2.2 Menu structure

Menu items	Description	Symbol on the display
<i>ROTOR</i> menu item	<p>Setting the radius for tube and adapter</p> <ul style="list-style-type: none"> • Selecting the rotor <ul style="list-style-type: none"> – FA-24×2 – FA-18×2 – FA-10×5 – F-32×0.2-PCR – S-96×0.2 • Selecting the tube volume <ul style="list-style-type: none"> – 0_2ML – 0_4ML – 0_5ML – 0_6ML – 2_0ML – 5_0ML – HPLC – CRYO 	
<i>RAMPS</i> menu item	<p>Acceleration ramp and braking ramp</p> <ul style="list-style-type: none"> • Level ACC 9/BRK 9: shortest acceleration time/braking time (setting on delivery) • Level ACC 0/BRK 0: longest acceleration time/braking time <ol style="list-style-type: none"> 1. Select the acceleration ramp (<i>ACCEL</i>) or braking ramp (<i>BRAKE</i>) 2. Select the level 	9/9
<i>ATSET</i> menu item	<p>Setting the start for time counting</p> <ul style="list-style-type: none"> • OFF: time counting begins immediately (setting on delivery) • ON: time counting starts when 95 % of the speed has been reached 	
<i>SHORT</i> menu item	<p>Setting the speed of the short spin centrifugation</p> <ul style="list-style-type: none"> • MAX: Short run centrifugation at the maximum speed of the inserted rotor. • SET: short spin centrifugation at the selected speed 	
<i>TIMER</i> menu item	<p>Setting a start delay for the centrifugation run</p> <ul style="list-style-type: none"> • ON: set the time span up to the start of the centrifugation run • OFF: centrifugation run starts immediately 	
<i>ALARM</i> menu item	<p>Switching the alarm on/off</p> <ul style="list-style-type: none"> • VOL 1 – VOL 5: set the volume of the alarm at the end of the centrifugation run • OFF: no acoustic signal at the end of the centrifugation run 	

Menu items	Description	Symbol on the display
<i>LOCK</i> menu item	Switching the write protection for the program on/off 1. Select <i>SET PROG</i> 2. Select the program with the prog 1 , prog 2 or prog 3 program key	
<i>SLEEP</i> menu item	Switching Sleep mode on/off • <i>ON</i> • <i>OFF</i>	
<i>LID</i> menu item	Switching automatic opening of the centrifuge lid on/off • <i>AUTO</i> • <i>OFF</i>	

5.3 Switching on the centrifuge

- ▶ Switch the centrifuge on at the mains/power switch.
 - The parameter settings of the last run are displayed.
 - The lid opens.

5.4 Replacing the rotor



NOTICE! Material damage due to improper rotor insertion.

The motor shaft or bearing may get damaged if the rotor falls into the motor shaft guides in an uncontrolled manner during insertion.

- ▶ Hold the rotor with both hands.
- ▶ Guide the rotor onto the motor shaft.

5.4.1 Inserting the rotor

1. Place the rotor vertically onto the motor shaft from the top.
2. Insert the supplied rotor key into the rotor nut.
3. Turn rotor key **clockwise** until the rotor nut is firmly tightened.

5.4.2 Removing the rotor

1. Turn the rotor nut **counterclockwise** using the supplied rotor key.
2. Lift the rotor out vertically.

5.4.3 Triggering rotor detection



CAUTION! Risk of injury when turning the rotor manually.

- ▶ When turning a swing-bucket rotor, pay special attention to ensure that your fingers do not get jammed or get caught on the swinging buckets.

The centrifuge detects whether the newly inserted rotor is a fixed-angle rotor or a swing-bucket rotor.

- ▶ In order to trigger rotor detection manually, turn the rotor **counterclockwise** by hand.
 - If the g -force (rcf) or speed (rpm) has been set higher, it will be limited to the maximum value of the rotor.
 - The maximum speed of the rotor is briefly displayed.
 - The *ROTOR* menu item is displayed.
- ▶ Select the name of the inserted rotor with the menu arrow keys and press **menu/enter** to confirm.
- ▶ To set the radius for the tubes and adapters used, select a tube volume and press **menu/enter** to confirm.



Triggering rotor detection using short-spin centrifugation

- ▶ Keep the **short** key pressed.
The maximum speed of the rotor is briefly displayed.

If a centrifugation run is started immediately after a rotor change, the centrifuge has not yet detected the new rotor.



- ▶ After each rotor change, check whether the new rotor is detected by the device.
- ▶ Check the set g -force (rcf) and/or speed (rpm) and adjust it, if required.

5.5 Preparing for centrifugation

5.5.1 Loading the rotor



CAUTION! Risk of injury due to asymmetric loading of a rotor.

- ▶ Load rotors symmetrically with identical tubes.
- ▶ Only load adapters with suitable tubes.
- ▶ Always use the same type of tubes (weight, material/density and volume).
- ▶ Check symmetric loading by balancing the adapters and tubes used with scales.

1. Check the maximum payload (adapter, tube and contents) for each rotor bore.
2. Load rotors and adapters only with the tubes intended for them.
3. To ensure symmetrical loading, insert sets of two tubes in opposite bores. Tubes located opposite each other must be of the same type and contain the same filling quantity.



Abb. 5-3: Symmetrical loading of a fixed-angle rotor

To keep the weight differences between the filled sample tubes low, we recommend balancing with a balance. This will reduce wear on the drive and reduce operating noise.

5.5.2 Closing the rotor lid

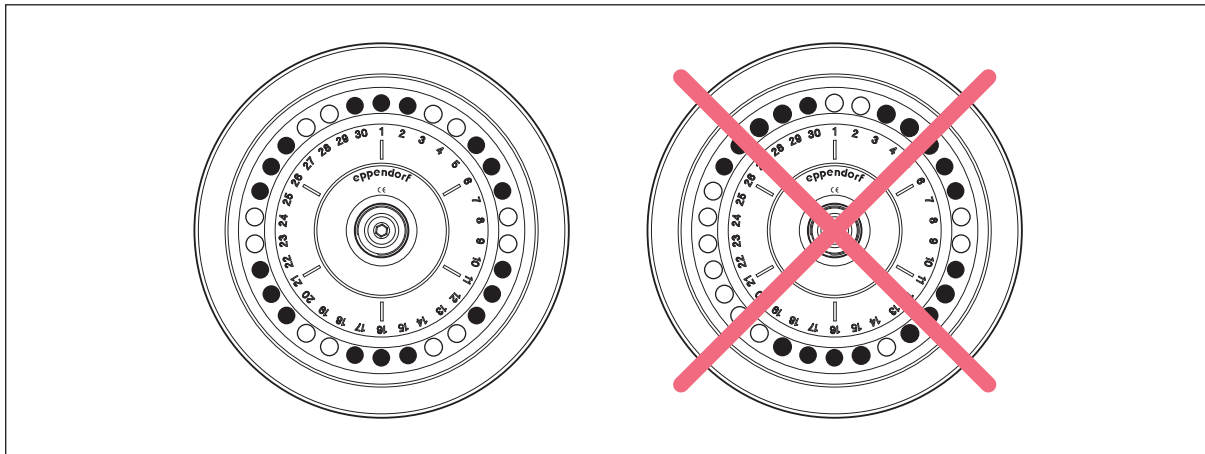

Use matching rotor lids

- Fixed-angle rotors may only be used with the appropriate rotor lid for the respective rotor. The rotor name on the rotor must correspond to the rotor name on the rotor lid.

1. Place the rotor lid vertically on the rotor.
2. Turn the rotor lid screw clockwise to seal the rotor.



With the rotors FA-24x2, FA-10x5 and FA-18x2-KIT, centrifugation is also possible without a rotor lid.

- The tube lids must be closed.
- The rotors are not aerosol-tight without rotor lid.
- The centrifugation is slightly louder.
- Spin columns must always be centrifuged with a rotor lid.



Spin columns

When centrifuging spin columns in the rotor FA-18x2-KIT, the tube lids may remain open if this is approved by the kit manufacturers. For reliable centrifugation, you must lean the open tube lids against the edge of the rotor. The tube lids may not protrude over the edge of the rotor.

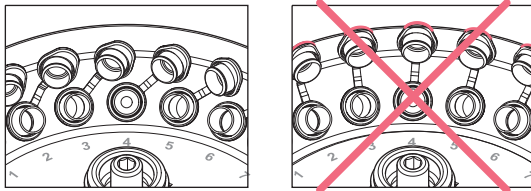

- ▶ Always centrifuge spin columns with rotor lid.

5.5.3 Closing the QuickLock rotor lid

Aerosol-tight rotors have a QuickLock rotor lid.



Identification of aerosol-tight rotors

An aerosol-tight rotor and the matching aerosol-tight rotor lid must be used for aerosol-tight centrifugation.

Aerosol-tight fixed-angle rotor

- Designation begins with **FA**
- **Red ring**

Aerosol-tight rotor lid

- Labeled **aerosol-tight**
- **Red lid screw**

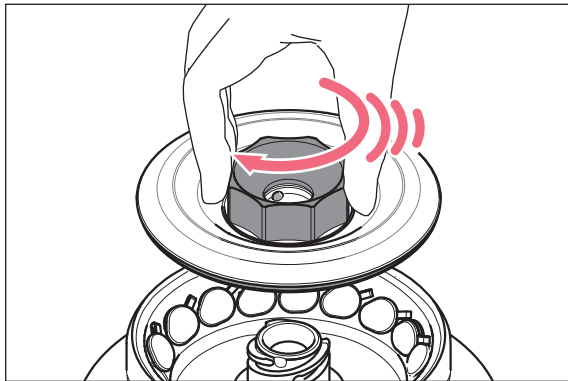

1. Check the correct positioning of the external sealing ring in the groove.
2. Place the rotor lid on the rotor in a vertical motion.
3. To lock the rotor, turn the red rotor lid screw clockwise as far as it will go, and after an audible "click" is heard.



The rotor is only properly locked after the audible "click" is heard!

5.6 Centrifugation

Prerequisites

- The centrifuge is switched on.
- The rotor has been inserted and attached correctly.
- The rotor has been loaded correctly.
- The rotor lid has been mounted correctly.
- Buckets can swing out freely.
- The centrifuge lid is closed.



WARNING! Risk of injury from improperly attached rotors and rotor lids.

- ▶ Only centrifuge with rotor and rotor lid firmly tightened.
- ▶ If there are any unusual noises when the centrifuge is started up, the rotor or rotor lid may not be properly attached. Immediately press the **start/stop** key to stop centrifuging.

5.6.1 Centrifuging with preset time

Setting the centrifugation parameters

1. Set the centrifugation time with the **time** arrow keys.
2. Set the speed (rpm) or *g*-force (rcf) with the **speed** arrow keys.

If the speed is set via the *g*-force (rcf): Set the rotor and tube volume according to the rotor tube combination used (see *Adjusting the radius: setting the rotor and the tube volume* on p. 32).

Starting the centrifugation run

3. To start the centrifugation run, press the **start/stop** key.

Display during centrifugation

-  flashes on the display while the rotor is running.
- Remaining run time in minutes. The last minute is counted down in seconds.
- Current *g*-force (rcf) and/or speed (rpm).



During the run you can change the following parameters:

- Centrifugation time
- Speed: During the run you can switch between the display of the *g*-force and the speed, using the **rpm/rcf** key.
- Acceleration ramp/braking ramp

The following keys are blocked during centrifugation:

- **open** key
- **short** key
- **prog 1** to **prog 3** program keys

5.6.2 End of centrifugation

- ▶ Press the **start/stop** key to end centrifugation before the set time.
 - The centrifuge stops automatically when the set time has elapsed.
 - During the braking process, the elapsed running time flashes on the display.
 - If the speaker is switched on, a signal sounds when the rotor has stopped.
 -  Time counter after rotor stop: the time from the rotor stop is counted up to 9:59 h on the display. Additionally, ∞ is displayed.
 - *LID > AUTO* setting: the centrifuge lid opens automatically.
 - *LID > OFF* setting – automatic opening of the centrifuge lid is deactivated:
 - The LED of the **open** key flashes.
 - The centrifuge lid remains sealed.
 Press the **open** key to open the lid.

5.6.3 Centrifuging in continuous operation

Setting continuous run

1. In order to centrifuge without any time limits, use the **time** arrow keys to select the setting ∞ (▼ below 10 s or ▲ above 9:59 h).
2. Set the speed (rpm) or *g*-force (rcf) with the **speed** arrow keys.
If the speed is set via the *g*-force (rcf): set the rotor and the tube volume (see p. 32).
3. To start the centrifugation run, press the **start/stop** key.
 -  flashes on the display while the rotor is running.
 - The cycle time is counted up.
 - Current *g*-force (rcf) and/or speed.

5.6.4 Short run centrifugation

All keys are disabled during short run centrifugation except the **start/stop** key.

Setting in the menu item *SHORT*:

- *MAX*: Short run centrifugation at the maximum speed of the inserted rotor.
- *SET*: Short run centrifugation at a freely selected speed.

- ▶ To start a short run centrifugation, press or press and hold the **short** key.

Functions of the **short** key:

- Pressing and holding the **short** key: centrifuge runs for as long as the **short** key is pressed.
- Briefly pressing the **short** key: centrifuge accelerates up to the set speed (*MAX* or *SET*) and then decelerates.

5.6.5 Adjusting the radius: setting the rotor and the tube volume

By default, the conversion from speed (rpm) to *g*-force (rcf) is based on the biggest radius of the rotor. If an adapter is used for tubes, the radius is reduced. Adjust the radius by selecting the tube via the *ROTOR* menu item.

Selecting the rotor

1. Press the **menu/enter** key. Use the menu arrow keys to select *ROTOR*. Confirm with the **menu/enter** key.
2. Select a rotor with the ▲ or ▼ menu arrow keys. Confirm with the **menu/enter** key.

Selecting the tube volume

3. Select the tube volume with the ▲ or ▼ menu arrow keys. Confirm with the **menu/enter** key.
 - The *g*-force (rcf) is adjusted to the value of the radius.
 - The display shows \emptyset .

5.6.6 Setting the acceleration ramp and braking ramp



You can set the acceleration and braking times in levels from 0 to 9.





- Level 9: shortest acceleration time/braking time (setting on delivery).
- Level 0: longest acceleration time/braking time.

1. Press the **menu/enter** key. Use the menu arrow keys to select *RAMPS*. Confirm with the **menu/enter** key.
2. Use the ▲ or ▼ menu arrow keys to select *ACCEL* or *BRAKE*. Confirm with the **menu/enter** key.
3. Use the ▲ or ▼ menu arrow keys to select the level. Confirm with the **menu/enter** key.

5.6.7 Setting the start for time counting (*ATSET*)



You can set the start of the time counting via the *ATSET* function:

- Time counting begins immediately: *ATSET* > *OFF*  (setting on delivery).
- Time counting starts when 95 % of the speed has been reached: *ATSET* > *ON* 

1. Press the **menu/enter** key. Use the menu arrow keys to select *ATSET*. Confirm with the **menu/enter** key.
2. Use the ▲ or ▼ menu arrow keys to select *OFF*  or *ON* . Confirm with the **menu/enter** key.
The display shows  or .

5.6.8 Setting the start of the centrifugation run (TIMER)

Use the *TIMER* function to delay the start of the centrifugation run, e.g., to bridge an incubation period.

1. Press the **menu/enter** key. Use the menu arrow keys to select *TIMER*. Confirm with the **menu/enter** key.
The  symbol flashes on the display.
2. Select *ON* with the menu arrow keys ▲ or ▼.
3. Use the **time** arrow keys to set the time period until start of the centrifugation run (10 s – 9:59 h).
Confirm with the **menu/enter** key.
A tick appears in front of the selected setting. The setting takes effect immediately. The display switches to the *TIMER* menu item.
 - When the *TIMER* function is activated, the display shows .
 - The settings are effective during the next centrifugation run only. After the centrifugation run, the function is disabled again.

5.7 Aerosol-tight centrifugation



WARNING! Risk to health due to limited aerosol tightness with incorrect rotor/rotor lid combination.

Aerosol-tight centrifugation is guaranteed only if the rotors and rotor lids intended for this purpose are used. The designation of aerosol-tight fixed-angle rotors always starts with **FA**. The aerosol-tight rotors and rotor lids of this centrifuge are additionally marked with a red ring on the rotor and a red rotor lid screw.

- ▶ Always use rotors and rotor lids marked aerosol-tight together for aerosol-tight centrifugation. The details specifying in which centrifuge you may use the aerosol-tight rotors and rotor lids can be found on the rotor and on the upper side of the rotor lid.
- ▶ Only use aerosol-tight rotor lids in combination with rotors which are marked on the rotor lid.



WARNING! Damage to health as a result of impaired aerosol tightness due to incorrect usage.

Autoclaving, mechanical stresses and contamination with chemicals or other aggressive solutions can impair the aerosol tightness of the rotors and rotor lids.

- ▶ Check the integrity of the seals of the aerosol-tight rotor lids or caps before each use.
- ▶ Only use aerosol-tight rotor lids or caps if the seals are undamaged and clean.
- ▶ Lightly grease the threads of the rotor lid screw with pivot grease after every proper autoclaving (121 °C, 20 min.) (int. order no. Int. 5810 350.050, North America 022634330).
- ▶ On QuickLock rotor lids, only the seal must be replaced after 50 autoclaving cycles.
- ▶ **Never** store aerosol-tight rotors or buckets closed.



The aerosol tightness of rotors, rotor lids, buckets and caps has been tested and certified according to Annex AA of IEC 61010-2-020.

5.7.1 Aerosol-tight centrifugation in a fixed-angle rotor

Aerosol-tight fixed-angle rotors have a QuickLock rotor lid.

- ▶ Replace the seals of QuickLock rotor lids after 50 autoclaving cycles.
- ▶ Replace damaged seals of QuickLock rotor lids.

5.8 Switching off the centrifuge

1. Open the centrifuge lid.
Residual moisture can evaporate.
2. Remove rotor lids from fixed-angle rotors.
Aerosol-tight accessories may not be stored with the lid closed.
3. Switch off the centrifuge using the mains/power switch.

6 Programs

6.1 Creating a new program

The Centrifuge 5425 has 3 program slots.

Apart from the parameters centrifugation time and speed, you can define the settings for the following options separately for each program:

Adjusting the radius for the tube used	<i>ROTOR</i> menu item
Acceleration ramp	<i>RAMPS > ACCEL</i> menu item
Braking ramp	<i>RAMPS > BRAKE</i> menu item
Setting start of time counting	<i>ATSET</i> menu item
Delaying the start of the centrifugation run	<i>TIMER</i> menu item
Adding write protection to a program	<i>LOCK</i> menu item

6.1.1 Saving a program

Prerequisites

Rotor stop

1. Set the centrifugation time with the **time** arrow keys.
2. Set the speed (rpm) or *g*-force (rcf) with the **speed** arrow keys.

Defining additional options of the program

3. Open the menu using the **menu/enter** key.
4. Select an option, for instance, *ATSET*, with the menu arrow keys ▲ or ▼. Confirm with the **menu/enter** key.
5. Change the setting with the ▲ or ▼ menu arrow keys. Confirm with the **menu/enter** key.

Saving a program

6. Keep one of the program keys **prog 1** to **prog 3** pressed for 2 seconds.
 - The program key lights up in blue.
 - The parameters of the program are saved.

6.1.2 Adding write protection to a program

1. Open the menu using the **menu/enter** key.
2. Select *LOCK* with the menu arrow keys ▲ or ▼. Confirm with the **menu/enter** key.
 - The display shows *SET PROG*.
 - The  symbol flashes on the display.
3. Press one of the program keys **prog 1** to **prog 3**.
The program key lights up in blue.
4. Confirm with the **menu/enter** key.
The display switches to the *LOCK* menu item.
5. In order to leave the menu, select *BACK* and confirm with **menu/enter**.

6.2 Loading a saved program

6.2.1 Loading program prog 1 to prog 3

1. To call up a program, press one of the program keys **prog 1 to prog 3**.
 - The program key lights up in blue.
 - The display shows the parameters of the program.
2. Start the program: press the **start/stop** key.

6.3 Overwriting programs

The programs can not be deleted. All parameters of a program can be changed and overwritten.

6.3.1 Removing the write protection of programs

1. Open the menu using the **menu/enter** key.
2. Select *LOCK* with the menu arrow keys ▲ or ▼. Confirm with the **menu/enter** key.
 - The display shows *SET PROG*.
 - The  symbol flashes on the display.
 - The program keys of write-protected programs light up in blue.
3. Press an illuminated program key.
 - The light of the program key goes off.
 - The write-protection of the program is removed.
4. Confirm with the **menu/enter** key.
The display switches to the *LOCK* menu item.
5. In order to leave the menu, select *BACK* and confirm with **menu/enter**.

6.3.2 Editing programs

Prerequisites

The write protection of the program is removed

1. To select a program, press the program keys **prog 1 to prog 3**.
 - The program key lights up in blue.
 - The display shows the parameters of the program.
2. Change parameters and options .
The light of the program key goes off.
3. To save the changed parameters, press the program key for 2 seconds.
 - The program key lights up in blue.
 - The parameters of the program are saved.

7 Device settings

7.1 Setting alarms

You can set the volume of the acoustic signal after completion of the centrifugation run.

7.1.1 Activating the alarm

1. Press the **menu/enter** key. Use the menu arrow keys to select *ALARM*. Confirm with the **menu/enter** key.

The 🔔 symbol flashes on the display.

2. To set the volume of the acoustic alarm use the menu arrow keys ▲ or ▼ to select *VOL 1 – VOL 5*. Confirm with the **menu/enter** key.

A tick appears in front of the selected setting. The setting takes effect immediately. The display switches to the *ALARM* menu item.

3. In order to leave the menu, select *BACK* and confirm with **menu/enter**.

The display shows 🔔.

7.1.2 Deactivating the alarm

1. Press the **menu/enter** key. Use the menu arrow keys to select *ALARM*. Confirm with the **menu/enter** key.

The 🔔 symbol flashes on the display.

2. Select *OFF* with the menu arrow keys ◀ or ▶. Confirm with the **menu/enter** key.

A tick appears in front of the selected setting. The setting takes effect immediately. The display switches to the *ALARM* menu item.

3. In order to leave the menu, select *BACK* and confirm with **menu/enter**.

The display shows 🔕.

7.2 Sleep mode

In sleep mode the display shows *EP*, if the centrifuge has not been used for more than 15 minutes. To reactivate the display, press a key or close the centrifuge lid.

7.2.1 Activating the sleep mode

1. Press the **menu/enter** key. Use the menu arrow keys to select *SLEEP*. Confirm with the **menu/enter** key.
2. Use the menu arrow keys to select *ON*. Confirm with the **menu/enter** key.

A tick appears in front of the selected setting. The setting takes effect immediately. The display switches to the *SLEEP* menu item.

3. In order to leave the menu, select *BACK* and confirm with **menu/enter**.

7.2.2 Deactivating the sleep mode

1. Press the **menu/enter** key. Use the menu arrow keys to select *SLEEP*. Confirm with the **menu/enter** key.
2. Use the menu arrow keys to select *OFF*. Confirm with the **menu/enter** key.
A tick appears in front of the selected setting. The setting takes effect immediately. The display switches to the *SLEEP* menu item.
3. In order to leave the menu, select *BACK* and confirm with **menu/enter**.

7.3 Automatic lid opening

You can set whether you want the centrifuge lid to open automatically after completion of a centrifugation run or to remain closed.

7.3.1 Activating automatic lid opening

1. Press the **menu/enter** key. Use the menu arrow keys to select *LID*. Confirm with the **menu/enter** key.
2. Use the menu arrow keys to select *AUTO*. Confirm with the **menu/enter** key.
A tick appears in front of the selected setting. The setting takes effect immediately. The display switches to the *LID* menu item.
3. In order to leave the menu, select *BACK* and confirm with **menu/enter**.

7.3.2 Deactivating automatic lid opening

1. Press the **menu/enter** key. Use the menu arrow keys to select *LID*. Confirm with the **menu/enter** key.
2. Use the menu arrow keys to select *OFF*. Confirm with the **menu/enter** key.
A tick appears in front of the selected setting. The setting takes effect immediately. The display switches to the *LID* menu item.
3. In order to leave the menu, select *BACK* and confirm with **menu/enter**.

If automatic lid opening is deactivated, the centrifuge lid is opened via the **open** key.

8 Maintenance

8.1 Service

We recommend to have the centrifuge and the associated rotors checked by Technical Service during a service at least every 12 months. Please note the country-specific regulations.

8.2 Preparing cleaning/disinfection

- ▶ Clean all accessible surfaces of the device and the accessories at least weekly and when contaminated.
- ▶ Clean the rotor regularly. This way the rotor is protected and the durability is prolonged.
- ▶ Furthermore, observe the notes on decontamination (see *Decontamination before shipment on p. 44*) when the device is sent to the authorized Technical Service for repairs.

The procedure described in the following chapter applies to the cleaning as well as to the disinfection or decontamination. The table below describes the steps required on top of this:

Cleaning	Disinfecting/decontamination
<ol style="list-style-type: none"> 1. Use a mild cleaning fluid to clean the accessible surfaces of the device and the accessories. 2. Carry out the cleaning as described in the following chapter. 	<ol style="list-style-type: none"> 1. Choose the disinfection method which corresponds to the legal regulations and guidelines in place for your range of application. For example, use alcohol (ethanol, isopropanol) or alcohol-based disinfectants. 2. Carry out the disinfection or decontamination as described in the following chapter. 3. Then clean the device and the accessories.



If you have any further questions regarding the cleaning and disinfection or decontamination or regarding the cleaning fluid to be used, contact the Eppendorf AG Application Support. The contact details are provided on the back of this manual.

8.3 Cleaning/disinfection



DANGER! Electric shock as a result of penetration of liquid.

- ▶ Switch off the device and disconnect the power plug before starting cleaning or disinfection work.
 - ▶ Do not allow any liquids to penetrate the inside of the housing.
 - ▶ Do not spray clean/spray disinfect the housing.
 - ▶ Only plug the device back in if it is completely dry, both inside and outside.
-



NOTICE! Damage from the use of aggressive chemicals.

- ▶ Do not use any aggressive chemicals on the device or its accessories, such as strong and weak bases, strong acids, acetone, formaldehyde, halogenated hydrocarbons or phenol.
- ▶ If the device has been contaminated by aggressive chemicals, immediately clean it by means of a mild cleaning agent.



NOTICE! Corrosion due to aggressive cleaning agents and disinfectants.

- ▶ Do not use corrosive cleaning agents, aggressive solvents or abrasive polishes.
- ▶ Do not incubate the accessories in aggressive cleaning agents or disinfectants for a longer period of time.



NOTICE! Damage from UV and other high-energy radiation.

- ▶ Do not use UV, beta, gamma, or any other high-energy radiation for disinfecting.
 - ▶ Avoid storage in areas with strong UV radiation.
-



Autoclaving

Rotors, rotor lids and adapters can be autoclaved (121 °C, 20 min).
Replace the seal on QuickLock rotor lids after 50 autoclaving cycles.

8.3.1 Cleaning and disinfecting the device

1. Open the lid. Switch the device off at the mains/power switch. Disconnect the mains/power plug from the voltage supply.
2. Remove the rotor.
3. Clean and disinfect all accessible surfaces on the device including the mains/power cord using a damp cloth and recommended cleaning agents.
4. Wash the rubber seal in the rotor chamber thoroughly with water.
5. Rub the dry rubber seal with glycerol or talcum powder to prevent it from becoming brittle. Other components of the device, such as the motor shaft and rotor cone, must not be lubricated.
6. Clean the motor shaft with a soft, dry, lint-free cloth. Do not grease the motor shaft.
7. Check the motor shaft for damage.
8. Check the device for corrosion and damage.
9. Leave the centrifuge lid open when the device is not being used.
10. Only connect the device to the power supply if it is fully dry inside and out.

8.3.2 Disinfecting and cleaning the rotor

1. Inspect the rotor and accessories for damage and corrosion. Do not use any damaged rotors or accessories.
2. Clean and disinfect the rotors and accessories using the recommended cleaning agents.
3. Clean and disinfect the rotor bores using a bottle brush.
4. Rinse the rotors and accessories thoroughly with distilled water. Rinse the rotor bores of fixed-angle rotors particularly thoroughly.



Do not immerse the rotor in liquid as liquid can enter through the openings when doing so.

5. Place the rotors on a towel to dry. Place fixed-angle rotors with the rotor bores facing downwards to allow the bores to also dry.
6. Clean the rotor cone with a soft, dry, lint-free cloth. Do not lubricate the rotor cone.
7. Inspect the rotor cone for damage.
8. Place the dry rotor onto the motor shaft.
9. Tighten the rotor nut by turning it **clockwise**.
10. Leave the rotor lid open when the rotor is not being used.

8.3.3 Cleaning and disinfecting the rotor lid



1. Remove the sealing ring to thoroughly clean the groove below it.

2. Clean and disinfect the rotor lid using the recommended cleaning agents.
3. Place the rotor lid on a towel to dry.
4. Check that the seal is not damaged. Do not use any damaged, discolored or dirty seals.



5. Wet the sealing ring with distilled water.

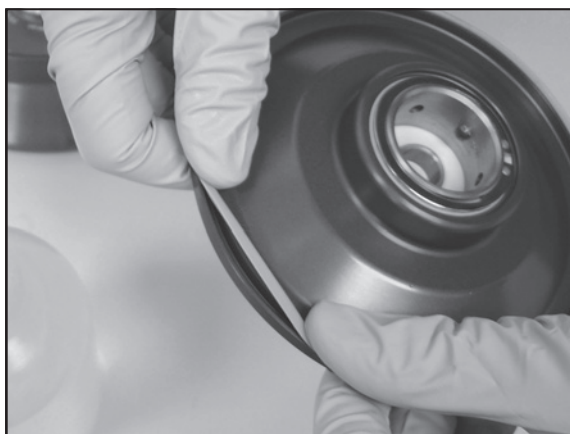

6. Insert the sealing ring exactly in the clean and dry groove of the rotor lid.

7. Lightly grease the inserted sealing ring with pivot grease.
8. Leave the rotor lid open when the rotor is not being used.



The rotor lid cannot close properly if the sealing ring is not correctly inserted.

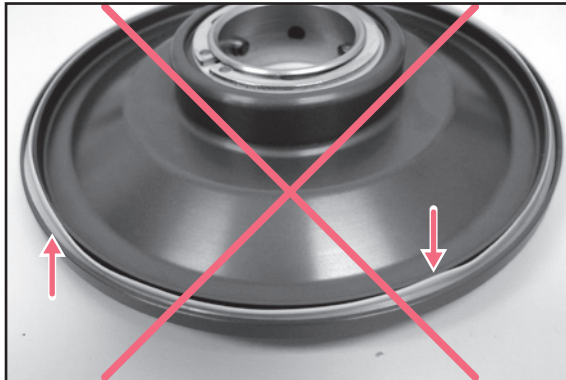

8.4 Cleaning glass breakage

When using glass tubes there is a risk of glass breakage in the rotor chamber. The resulting glass splinters are swirled around in the rotor chamber during centrifugation and have a sandblasting effect on the rotor and accessories. Smallest glass particles become lodged in the rubber parts (e.g., the motor sleeve, the rotor chamber seal, and the rubber mats of adapters).



NOTICE! Glass breakage in the rotor chamber

Glass tubes in the rotor chamber may break if the g -force is too high. Broken glass can damage the rotor, accessories and samples.

- ▶ Please note the manufacturer's information on the recommended centrifugation parameters (load and speed).

Effects of glass breakage in the rotor chamber:

- Fine black metal abrasion in the rotor chamber (in metal rotor bowls).
- The surfaces of the rotor chamber and accessories are scratched.
- The chemical resistance of the rotor chamber is reduced.
- Contamination of samples.
- Wear on rubber parts.

How to proceed in case of glass breakage

1. Remove all splinters and glass powder from the rotor chamber and accessories.
2. Thoroughly clean the rotor and rotor chamber. Thoroughly clean the bores of the fixed-angle rotors, in particular.
3. Regularly check the rotor bores for deposits and damage.

8.5 Replacing fuses

The fuse holder is located under the mains power socket.

1. Disconnect the mains/power plug.
2. Remove the fuse holder.
3. Replace faulty fuses and reinsert the fuse holder.

8.6 Decontamination before shipment

If you are shipping the device to the authorized Technical Service for repairs or to your authorized dealer for disposal please note the following:



WARNING! Risk to health from contaminated device.

1. Observe the information on the decontamination certificate. You can find it as a PDF document on our webpage (www.eppendorf.com/decontamination).
 2. Decontaminate all the parts you would like to dispatch.
 3. Include the fully completed decontamination certificate in the package.
-

9 Troubleshooting

If you cannot remedy an error with the recommended measures, please contact your local Eppendorf partner. The contact addresses can be found on the Internet at www.eppendorf.com.

9.1 General errors

Problem	Cause	Solution
No display.	No mains/power connection.	▶ Check the mains/power connection.
	Mains/power outage.	▶ Check the fuse of the device. ▶ Check the mains/power fuse of the lab.
The centrifuge lid cannot be opened.	Rotor is still running.	▶ Wait for rotor to stop.
	Mains/power outage.	1. Check the fuse of the device. 2. Check the mains/power fuse of the lab. 3. Actuate emergency release.
The centrifuge cannot be started.	Centrifuge lid is not closed.	▶ Close the centrifuge lid.
Centrifuge shakes when it starts up.	Rotor loaded asymmetrically.	1. Stop the centrifuge and load the rotor symmetrically. 2. Re-start the centrifuge.

9.2 Error messages

If an error message appears, proceed as follows:

1. Remedy the fault as described in the "Remedy" column.
2. To clear the error message from the display, press the **open** key.
3. If necessary, repeat centrifugation.

Problem	Cause	Solution
<i>IMBAL</i>	Rotor loaded asymmetrically.	▶ Load the rotor symmetrically and balance it.
<i>INT</i>	Mains/power failure during a run.	▶ Check the mains/power supply.
<i>LID ERROR</i>	Centrifuge lid cannot be locked.	▶ Try again to close centrifuge lid.
	Centrifuge lid cannot be released.	1. Switch off centrifuge and wait for 20 s. 2. Switch on the centrifuge. If the error occurs again: 1. Switch off the centrifuge. 2. Activate the emergency lid release.
	Prohibited opening of lid during a run or lid switch defective	1. Wait for rotor to stop. 2. Open the centrifuge lid and then close it again. 3. Repeat the run.
<i>LID LIFT</i>	Centrifuge lid has not been opened wide enough.	▶ Open the centrifuge lid wider by hand.
<i>NO RPM</i>	Error in the rotational speed measurement system	▶ Leave the device switched on until the rotor stops and the error message disappears (up to 15 min).
<i>ERROR 6</i>	Error in the drive electronics	▶ Repeat the run. If the error message appears again: 1. Switch off centrifuge and wait for 20 s. 2. Switch on the centrifuge.
<i>ERROR 7</i>	Deviation in the speed check.	1. Wait for rotor to stop. 2. Tighten the rotor.
<i>ERROR 10</i>	Electronics fault	1. Switch off centrifuge and wait for 20 s. 2. Switch on the centrifuge.
<i>ERROR 16</i>	Electronics fault	1. Switch off centrifuge and wait for 20 s. 2. Switch on the centrifuge.
<i>ERROR 20</i>	Drive overheated	▶ Allow the drive to cool down for at least 15 min.
<i>ERROR 22</i>	Electronics fault	1. Switch off centrifuge and wait for 20 s. 2. Switch on the centrifuge.
<i>ERROR 27</i>	Electronics fault	1. Switch off centrifuge and wait for 20 s. 2. Switch on the centrifuge.

9.3 Emergency release



WARNING! Risk of injury from rotating rotor.

If the emergency release of the lid is operated, the rotor may continue rotating for several minutes.

- ▶ Wait until the rotor has stopped before operating the emergency release.
 - ▶ To check, look through the monitoring glass in the centrifuge lid.
-

If the centrifuge lid does not open, you can open it manually using the emergency release.



Use the rotor key to operate the emergency release.

1. Disconnect the mains/power plug.
2. Remove the plastic cover of the emergency release on the left side of the device.
Turn the plastic cover 90° **counterclockwise** using an appropriate tool (e.g., screwdriver) and remove it.
3. Insert the centrifuge rotor key into the hexagonal opening behind the plastic cover until a noticeable resistance is felt.
4. Turn the rotor key **counterclockwise**.
This will release the centrifuge lid.
5. Open the centrifuge lid.
6. Remove the rotor key and reattach the plastic cover.
Turn the plastic cover using an appropriate tool (e.g., screwdriver) by 90° in a **clockwise** direction.

10 Transport, storage and disposal

10.1 Transport

- ▶ Remove the rotor from the centrifuge before transport.
- ▶ Use the original packing for transport.

	Air temperature	Relative humidity	Atmospheric pressure
General transport	-25 °C – 60 °C	10 % – 75 %	30 kPa – 106 kPa
Air freight	-20 °C – 55 °C	10 % – 75 %	30 kPa – 106 kPa

10.2 Storage

	Air temperature	Relative humidity	Atmospheric pressure
In transport packing	-25 °C – 55 °C	10 % – 75 %	70 kPa – 106 kPa
Without transport packing	-5 °C – 45 °C	10 % – 75 %	70 kPa – 106 kPa

10.3 Disposal

If the product needs to be disposed of, the relevant legal regulations must be observed.

Information on the disposal of electrical and electronic devices in the European Community:

Within the European Community, the disposal of electrical devices is regulated by national regulations based on EU Directive 2012/19/EU pertaining to waste electrical and electronic equipment (WEEE).

According to these regulations, any devices supplied after August 13, 2005, in the business-to-business sphere, to which this product is assigned, may no longer be disposed of in municipal or domestic waste. To document this, they have been marked with the following marking:



Because disposal regulations may differ from one country to another within the EU, please contact your supplier if necessary.

11 Technical data

11.1 Power supply

Centrifuge 5425

Mains/power connection	230 V, 50 Hz – 60 Hz 120 V, 50 Hz – 60 Hz 100 V, 50 Hz – 60 Hz
Current consumption	230 V: 1.8 A 120 V: 3.8 A 100 V: 4.5 A
Power consumption	230 V: 280 W 120 V: 280 W 100 V: 280 W
EMC: noise emission (radio interference)	230 V: EN 61326-1/EN 55011 – Class B 120 V: CFR 47 FCC Part 15 – Class B 100 V: EN 61326-1/EN 55011 – Class B
EMC: noise immunity	EN 61326-1
Overvoltage category	II
Protection class	I
Fuses	Time-delay fuse, 5 mm × 20 mm 230 V: 4.0 A 120 V: 8.0 A 100 V: 8.0 A
Degree of pollution	2

11.2 Ambient conditions

Environment	For indoor use only
Ambient temperature	2 °C – 40 °C
Relative humidity	10 % – 80 %, non-condensing
Atmospheric pressure	75 kPa – 106 kPa Use up to a height of 2 000 m above sea level.

11.3 Weight/dimensions

Dimensions	Width: 24 cm (9.45 in) Depth: 39 cm (15.35 in) Height: 24 cm (9.45 in)
Weight without rotor	15.6 kg (34.39 lb)

11.4 Noise level

The noise level was measured according to DIN EN ISO 3745 frontally in a sound measuring room with accuracy class 1 at a distance of 1 m from the device and at lab bench height.

Noise level	< 51 dB(A)
-------------	------------

11.5 Application parameters

Cycle time	10 s – 9:59 h, unlimited (∞) <ul style="list-style-type: none"> • 10 s – 2 min: can be set in increments of 10 s • 2 min – 10 min: can be set in increments of 30 s • 10 min – 9:59 h: can be set in increments of 1 min
Rotational speed	100 rpm – 15060 rpm <ul style="list-style-type: none"> • 100 rpm – 2000 rpm: can be set in increments of 10 rpm • 2000 rpm – 5000 rpm: can be set in increments of 50 rpm • 5000 rpm – 15060 rpm: can be set in increments of 100 rpm
Relative centrifugal force	$1 \times g$ – $21330 \times g$ <ul style="list-style-type: none"> • $1 \times g$ – $2000 \times g$: can be set in increments of $10 \times g$ • $2000 \times g$ – $5000 \times g$: can be set in increments of $50 \times g$ • $5000 \times g$ – $21330 \times g$: can be set in increments of $100 \times g$
Maximum load	Fixed-angle rotor: 10×5 mL Swing-bucket rotors: 96×0.2 mL
Maximum kinetic energy	4.136 kJ
Permitted density of the material for centrifuging (at maximum g -force (rcf) and/or speed (rpm) and maximum load)	1.2 g/mL
Inspection obligation in Germany	No

11.6 Acceleration and deceleration times

The following table shows the approximate acceleration and deceleration times according to DIN 58970 for the rotors of the Centrifuge 5425. The data was determined at maximum load of the rotor. Fluctuations may occur depending on the condition of the device and the load.

- Level 9: shortest acceleration time/deceleration time
- Level 0: longest acceleration time/deceleration time (brake off)

Rotor		0	1	2	3	4	5	6	7	8	9
FA-24x2	Acceleration time	360 s	300 s	240 s	180 s	120 s	90 s	60 s	45 s	30 s	15 s
	Deceleration time	370 s	300 s	240 s	180 s	120 s	90 s	60 s	45 s	30 s	15 s
	Tolerance	–	–	±5 %*							

* 5 s minimum

11.7 Service life for accessories



CAUTION! Danger due to material fatigue.

If the service life is exceeded, it cannot be guaranteed that the material of the rotors and the accessories will withstand the stresses during centrifugation.

- ▶ Do not use any accessories whose maximum service life has been exceeded.

Eppendorf states the maximum service life of the rotors and accessories both in years and in the maximum number of cycles. The decisive factor for the service life is which case occurs first, usually this is the number of years in operation.

Each centrifugation run in which the rotor is accelerated and braked is counted as a cycle, independent of the speed and the duration of the centrifugation run.

Rotor	Maximum service life from commissioning onward	
FA-10x5	180 000 cycles	7 years
S-96x0.2-PCR	100 000 cycles	7 years

All other rotors and rotor lids can be used during the entire service life of the centrifuge if the following conditions are met:

- Proper use
- Recommended maintenance
- Undamaged condition

Accessories	Maximum service life after initial setup	
Rotor lid of polycarbonate (PC), polypropylene (PP) or polyetherimide (PEI)	–	3 years
QuickLock rotor lid		3 years
Seals in the QuickLock rotor lid	50 autoclaving cycles	–
Adapters	–	1 year

The date of manufacture is stamped on the rotors and buckets in the format *03/15* or *03/2015* (= March 2015). On the inside of the plastic-rotor lids and aerosol-tight caps, the date of manufacture is stamped in the form of a clock 🕒.

Measures to ensure aerosol tightness:

- ▶ Replace the seal of QuickLock rotor lids after 50 autoclaving cycles.

12 Rotors for the Centrifuge 5425



Eppendorf centrifuges may only be operated with rotors that are intended for use with the corresponding centrifuge.









- ▶ Only use rotors that are intended for use with the corresponding centrifuge.

Please note the manufacturer's information on the centrifugation resistance of the sample tubes used (maximum *g*-force).

12.1 Rotor FA-24x2 and rotor FA-24x2-PTFE

Aerosol-tight fixed-angle rotor for 24 tubes

	Max. <i>g</i> force:	21330 × <i>g</i>
	Max. rotational speed:	15060 rpm
Rotor FA-24x2 FA-24x2-PTFE	Max. load (adapter, tube and contents):	24 × 3.75 g

Tube	Tube Capacity Tubes per adapter/rotor	Adapter Order no. (international)	Bottom shape Diameter	Max. <i>g</i> -force
				Max. rotational speed Radius
	PCR tube 0.2 mL 1/24	 5425 715.005	conical Ø 6 mm	15975 × <i>g</i> 15060 rpm 6.3 cm
	Micro test tube 0.4 mL 1/24	 5425 717.008	conical Ø 6 mm	21330 × <i>g</i> 15060 rpm 8.4 cm
	Micro test tube 0.5 mL 1/24	 5425 716.001	– Ø 8 mm	18510 × <i>g</i> 15060 rpm 7.3 cm
	Microtainers 0.6 mL 1/24	 5425 716.001	– Ø 8 mm	21330 × <i>g</i> 15060 rpm 8.4 cm
	Micro test tube 1.5 mL/2 mL –/24	–	conical Ø 11 mm	21330 × <i>g</i> 15060 rpm 8.4 cm

Rotors for the Centrifuge 5425









Centrifuge 5425

English (EN)

12.2 Rotor FA-18x2 kit

Aerosol-tight fixed-angle rotor for 18 tubes







	Max. <i>g</i> force:	18565 × <i>g</i>
	Max. rotational speed:	15060 rpm
Rotor FA-18x2 kit	Max. load (adapter, tube and contents):	18 × 3.75 g

Tube	Tube Capacity Tubes per adapter/rotor	Adapter Order no. (international)	Bottom shape Diameter	Max. <i>g</i> -force
				Max. rotational speed Radius
	PCR tube 0.2 mL 1/18	 5425 715.005	conical Ø 6 mm	13211 × <i>g</i> 15060 rpm 5.2 cm
	Micro test tube 0.4 mL 1/18	 5425 717.008	conical Ø 6 mm	18565 × <i>g</i> 15060 rpm 7.3 cm
	Micro test tube 0.5 mL 1/18	 5425 716.001	– Ø 8 mm	15746 × <i>g</i> 15060 rpm 6.2 cm
	Microtainers 0.6 mL 1/18	 5425 716.001	– Ø 8 mm	18565 × <i>g</i> 15060 rpm 7.3 cm
	Micro test tube 1.5 mL/2 mL –/18	–	conical Ø 11 mm	18565 × <i>g</i> 15060 rpm 7.3 cm

12.3 Rotor FA-10x5

Aerosol-tight fixed-angle rotor for 10 tubes

	Max. <i>g</i> force:	21330 × <i>g</i>
	Max. rotational speed:	15060 rpm
Rotor FA-10x5	Max. load (adapter, tube and contents):	10 × 10.0 g

Tube	Tube Capacity Tubes per adapter/ rotor	Adapter Order no. (international)	Bottom shape Diameter	Max. <i>g</i> -force Max. rotational speed Radius
	HPLC vial 1/10	 5820 770.007	Ø 11 mm	16258 × <i>g</i> 15060 rpm 6.4 cm
	Cryo tube 1.0 mL/2.0 mL 1/10	 5820 769.009	Ø 13 mm	18540 × <i>g</i> 15060 rpm 7.3 cm
	Micro test tube 1.5 mL/2.0 mL 1/10	 5820 768.002	Open Ø 11 mm	17779 × <i>g</i> 15060 rpm 7.0 cm
	Eppendorf Tubes 5 mL -/10	–	conical Ø 17 mm	21330 × <i>g</i> 15060 rpm 8.4 cm

Rotors for the Centrifuge 5425



Centrifuge 5425

English (EN)

12.4 Rotor F-32x0.2-PCR

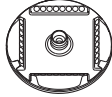

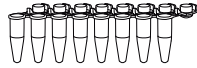
Fixed-angle rotor for PCR strips and PCR tubes

	Max. <i>g</i> force:	18134 × <i>g</i>
	Max. rotational speed:	15060 rpm
Rotor F-32x0.2-PCR	Max. load (tube and contents):	32 × 3.5 g

Tube	Tube Capacity Tubes per rotor	Bottom shape Diameter	Max. <i>g</i> -force
			Max. rotational speed
			Radius
	PCR strips 8 × 0.2 mL or 5 × 0.2 mL 4 × 8 or 4 × 5	conical Ø 6 mm	18134 × <i>g</i> 15060 rpm 7.2 cm
	PCR tube 0.2 mL 32	conical Ø 6 mm	18134 × <i>g</i> 15060 rpm 7.2 cm

12.5 Rotor S-96x0.2

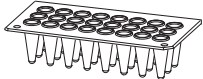
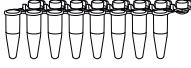
Swing-bucket rotor for PCR strips, PCR tubes and divisible Eppendorf twin.tec PCR Plate 96, unskirted (4 × 1/4)

	Max. <i>g</i> force:	3217 × <i>g</i>
	Max. rotational speed:	6000 rpm
Rotor S-96x0.2	Max. load per bucket (tubes and contents):	104 g
Tube	Tube Capacity Quantity per rotor	Max. <i>g</i> -force Max. rotational speed Radius
	Eppendorf twin.tec PCR Plate 96, unskirted, divisible 4 × 24 wells 4 × 1/4	3217 × <i>g</i> 6000 rpm 8.0 cm
	PCR strips 8 × 0.2 mL or 5 × 0.2 mL 12 × 8 or 12 × 5	3217 × <i>g</i> 6000 rpm 8.0 cm
	PCR tube 0.2 mL 96	3217 × <i>g</i> 6000 rpm 8.0 cm

Rotors for the Centrifuge 5425

Centrifuge 5425

English (EN)

13 Ordering information

Order no. (International)	Order no. (North America)	Description
5495 500.006	5495500006	Rotor FA-24x2 aerosol-tight, 24 × 1.5/2 mL tubes incl. aerosol-tight rotor lid, Centrifuge 5425
5495 501.002	5495501002	Rotor lid FA-24x2 aerosol-tight, aluminum
5495 503.005	5495503005	Rotor FA-24x2-PTFE aerosol-tight, 24 × 1.5/2 mL tubes incl. aerosol-tight rotor lid, Centrifuge 5425
5495 504.001	5495504001	Rotor lid FA-24x2-PTFE aerosol-tight, aluminum
5495 505.008	5495505008	Rotor FA-10x5 aerosol-tight, 10 × 5 mL tubes incl. aerosol-tight rotor lid, Centrifuge 5425
5495 506.004	5495506004	Rotor lid FA-10x5 aerosol-tight, aluminum
5495 508.007	5495508007	Rotor FA-18x2-KIT aerosol-tight, 18 × 1.5/2 mL tubes incl. aerosol-tight rotor lid, Centrifuge 5425
5495 509.003	5495509003	Rotor lid FA-18x2-KIT aerosol-tight, aluminum
5495 502.009	5495502009	Seal for rotor lid FA-24x2, FA-24x2-PTFE (Centrifuge 5425)
5495 507.000	5495507000	FA-10x5, FA-18x2 (Centrifuge 5425)
5495 510.001	5495510001	Rotor F-32x0.2-PCR 32 × 0.2 mL PCR tubes or 4 × 8 PCR tube strips incl. rotor lid, Centrifuge 5425
5495 511.008	5495511008	Rotor lid F-32x0.2-PCR aluminum
5495 512.004	5495512004	Rotor S-96x0.2-PCR 96 × 0.2 mL PCR tubes or 12 × 8 PCR tube strips incl. buckets
5495 513.000	5495513000	Bucket S-96x0.2-PCR 2 pcs.
5301 850.249	022654403	Fuse 4.0 A T (230 V), set of 2
5427 850.341	022654381	8.0 A T (120 V/100 V), set of 2

Ordering information

Centrifuge 5425

English (EN)

Declaration of Conformity

The product named below fulfills the requirements of directives and standards listed. In the case of unauthorized modifications to the product or an unintended use this declaration becomes invalid. This declaration of conformity is issued under the sole responsibility of the manufacturer.

Product name:

Centrifuge 5425

including components

Product type:

Centrifuge

Relevant directives / standards:

2006/42/EC: EN ISO 12100

2014/35/EU: EN 61010-1, EN 61010-2-020, IEC 61010-1, IEC 61010-2-020
UL 61010-1, UL 61010-2-020

CAN/CSA C22.2 No. 61010-1, CAN/CSA C22.2 No. 61010-2-020

2014/30/EU: EN 61326-1, EN 55011

47 CFR FCC part 15

2011/65/EU: EN 50581

Person authorized to compile
the technical file acc. to 2006/42/EC: Dr. Sven Bülow
Head of Business Unit Centrifugation
Eppendorf AG

Hamburg, January 25, 2018



Dr. Wilhelm Plüster
Management Board



Dr. Sven Bülow
Head of Business Unit
Centrifugation

Your local distributor: www.eppendorf.com/contact
Eppendorf AG · Barkhausenweg 1 · 22339 Hamburg · Germany
eppendorf@eppendorf.com

Eppendorf® and the Eppendorf Brand Design are registered trademarks of Eppendorf AG, Germany.
All rights reserved, incl. graphics and pictures. Copyright ©2017 by Eppendorf AG.

www.eppendorf.com

ISO
9001
Certified

ISO
13485
Certified

ISO
14001
Certified



Certificate of Containment Testing

Containment Testing of Rotor FA-24x2* in an Eppendorf 5425 Bench Top Centrifuge

Report No. 17/016 A

Report Prepared For: Eppendorf AG, Hamburg, Germany

Issue Date: 15 August 2017

Test Summary

Rotor FA-24x2* was containment tested in an Eppendorf 5425 bench top centrifuge, using Annex AA of IEC 61010-2-020:2016 (3rd Ed.). The sealed rotor was shown to contain a spill.

Report Written By

Name: Ms Anna Moy

Title: Biosafety Scientist

Report Authorised By

Name: Mrs Sara Speight

Title: Senior Biosafety Scientist

Please be aware that the use of the Royal Coat of Arms is highly restricted and cannot be copied. Please do not put the PHE logo on your website or use our name to endorse your products. Any reference to PHE needs to be approved by us before it can be used.



Public Health
England

Public Health England
National Infection Service
Porton Down
Salisbury
Wiltshire
SP4 OJG

Certificate of Containment Testing

Containment Testing of Rotor FA-24x2-PTFE* in an Eppendorf 5425 Bench Top Centrifuge

Report No. 17/016 B

Report Prepared For: Eppendorf AG, Hamburg, Germany

Issue Date: 15 August 2017

Test Summary

Rotor FA-24x2-PTFE* was containment tested in an Eppendorf 5425 bench top centrifuge, using Annex AA of IEC 61010-2-020:2016 (3rd Ed.). The sealed rotor was shown to contain a spill.

Report Written By

Name: Ms Anna Moy

Title: Biosafety Scientist

Report Authorised By

Name: Mrs Sara Speight

Title: Senior Biosafety Scientist

Please be aware that the use of the Royal Coat of Arms is highly restricted and cannot be copied. Please do not put the PHE logo on your website or use our name to endorse your products. Any reference to PHE needs to be approved by us before it can be used.

* Part no. will form part of catalogue number 5495 503.005



Public Health
England

Public Health England
National Infection Service
Porton Down
Salisbury
Wiltshire
SP4 OJG

Certificate of Containment Testing

Containment Testing of Rotor FA-10x5* in an Eppendorf 5425 Bench Top Centrifuge

Report No. 17/016 C

Report Prepared For: Eppendorf AG, Hamburg, Germany

Issue Date: 15 August 2017

Test Summary

Rotor FA-10x5* was containment tested in an Eppendorf 5425 bench top centrifuge, using Annex AA of IEC 61010-2-020:2016 (3rd Ed.). The sealed rotor was shown to contain a spill.

Report Written By

Name: Ms Anna Moy

Title: Biosafety Scientist

Report Authorised By

Name: Mrs Sara Speight

Title: Senior Biosafety Scientist

Please be aware that the use of the Royal Coat of Arms is highly restricted and cannot be copied. Please do not put the PHE logo on your website or use our name to endorse your products. Any reference to PHE needs to be approved by us before it can be used.

* Part no. will form part of catalogue number 5495 505.008



Certificate of Containment Testing

Containment Testing of Rotor FA-18x2-KIT* in an Eppendorf 5425 Bench Top Centrifuge

Report No. 17/016 D

Report Prepared For: Eppendorf AG, Hamburg, Germany

Issue Date: 15 August 2017

Test Summary

Rotor FA-18x2-KIT* was containment tested in an Eppendorf 5425 bench top centrifuge, using Annex AA of IEC 61010-2-020:2016 (3rd Ed.). The sealed rotor was shown to contain a spill.

Report Written By

Name: Ms Anna Moy

Title: Biosafety Scientist

Report Authorised By

Name: Mrs Sara Speight

Title: Senior Biosafety Scientist

Please be aware that the use of the Royal Coat of Arms is highly restricted and cannot be copied. Please do not put the PHE logo on your website or use our name to endorse your products. Any reference to PHE needs to be approved by us before it can be used.

Evaluate Your Manual

Give us your feedback.

www.eppendorf.com/manualfeedback

Your local distributor: www.eppendorf.com/contact

Eppendorf AG · Barkhausenweg 1 · 22339 Hamburg · Germany
eppendorf@eppendorf.com · www.eppendorf.com