



QüadCount™



Automatic Cell Counter

Instruction manual

Accuris Instruments

A division of Benchmark Scientific

PO Box 709, Edison, NJ 08818

Tel: 908-769-5555

E-mail: info@accuris-usa.com

Website www.accuris-usa.com

Package contents

QuadCount™ Automatic cell counter package includes the following items.

Item	Quantity
QuadCount™ main device	1
USB Memory Stick	1
Quick manual (PDF on Memory Stick)	1
Instruction manual (PDF on Memory Stick)	1
Main Power Cable	1
QuadCount™ Slides (Optional)	50 ea. per box
Keypad (Optional)	1
Barcode scanner (Optional)	1
Thermal printer (Optional)	1

When receiving the package,

- Check that all items listed above are included in your package.
- Examine the device carefully for any damage during shipping.
- Contact your local distributor or info@accuris-usa.com if any items are missing or damaged.
- Any loss or damage claims must be filed with the carrier.

Safety instruction

READ ALL INSTRUCTION BEFORE USE

Caution

- Check the power supply input voltage and make sure it matches the wall outlet voltage.
- Check that the power cable is connected to a grounded, 3-pin wall outlet.
- Check that the power cable is properly grounded to avoid potential electrical shock.
- Check that the main power switch is off when plugging in the power cable to the wall outlet or when unplugging the power cable.
- Power on using the main switch on the rear panel, wait about 2-3 minutes for the device to reboot.
- Do not insert any metallic objects into the device through backside air vent to avoid electrical shock causing personal injury or device damage.
- Place the device in an area where there is 10 cm clearance from other objects to allow for proper air-cooling.
- Do not disassemble the device. If service is needed, contact Accuris Instruments or an authorized distributor.
- Use authorized accessories only.
- Operator should have the general knowledge of laboratory techniques and cell counting procedures as well as safe handling of biological samples.
- Operate the device carefully as described in this manual.

Warning

• Battery

There is a Lithium battery inside the device. Replacing it with an incorrect type can cause risk of explosion. This battery should not be replaced by the user; contact Accuris an authorized service center if required.

• Sample handling

Samples may contain infectious biohazardous substances. Operator should wear gloves while handling all samples.

• Waste

Dispose used QuadCount™ Slides as biohazardous waste and do not reuse them.

Product specifications

QuadCount™



Voltage	AC 100~240 V, 50~60 Hz
Current	Max. 1.0 A, 50 W
Objective lens	4 x
Light source	4 W Green LED
Camera	5Mega pixels high resolution monochrome CMOS image sensor
Weight	5 Kg
Size (W × L × H)	163 × 293 × 216 mm
Measuring concentration range	$1 \times 10^4 \sim 1 \times 10^7$ cells/mL
Detectable cell diameter	5 ~ 60µm
Measuring speed*	Quick mode: ≈ 20s per test Normal mode: ≈ 30s per test Precise mode: ≈ 100s per test
Counting area	Quick mode: ≈ 0.15 µL Normal mode: ≈ 0.9 µL Precise mode: ≈ 3.6 µL

QuadSlides™ (Cat. No. E7500-S1 (Order separately))



Quantity	50 slides per box (for 200 tests)
Sample loading volume	20 µL

Accessories



Power Cable

USB Keypad or Barcode Scanner

Power cable	1.5 m
USB memory stick	Supports USB 2.0
(Optional) Keypad, Barcode scanner, thermal printer	USB type

*Cell Counting time can vary depending on cell type and concentration.

Device overview

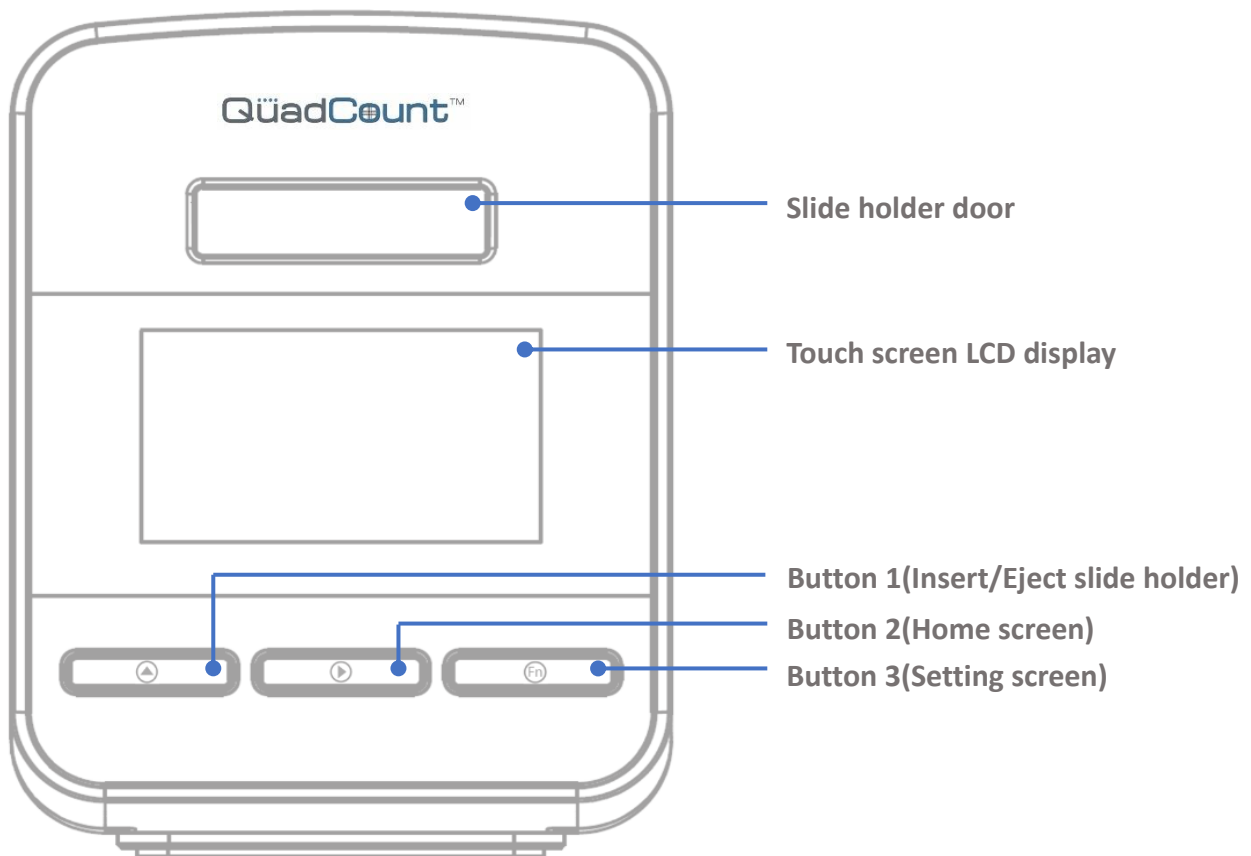

Front view

- Slide holder door – Slide holder is ejected from / inserted into the device.
- Touch LCD display – Preview, automatic cell counting processes and the results are displayed.
- 3 control buttons

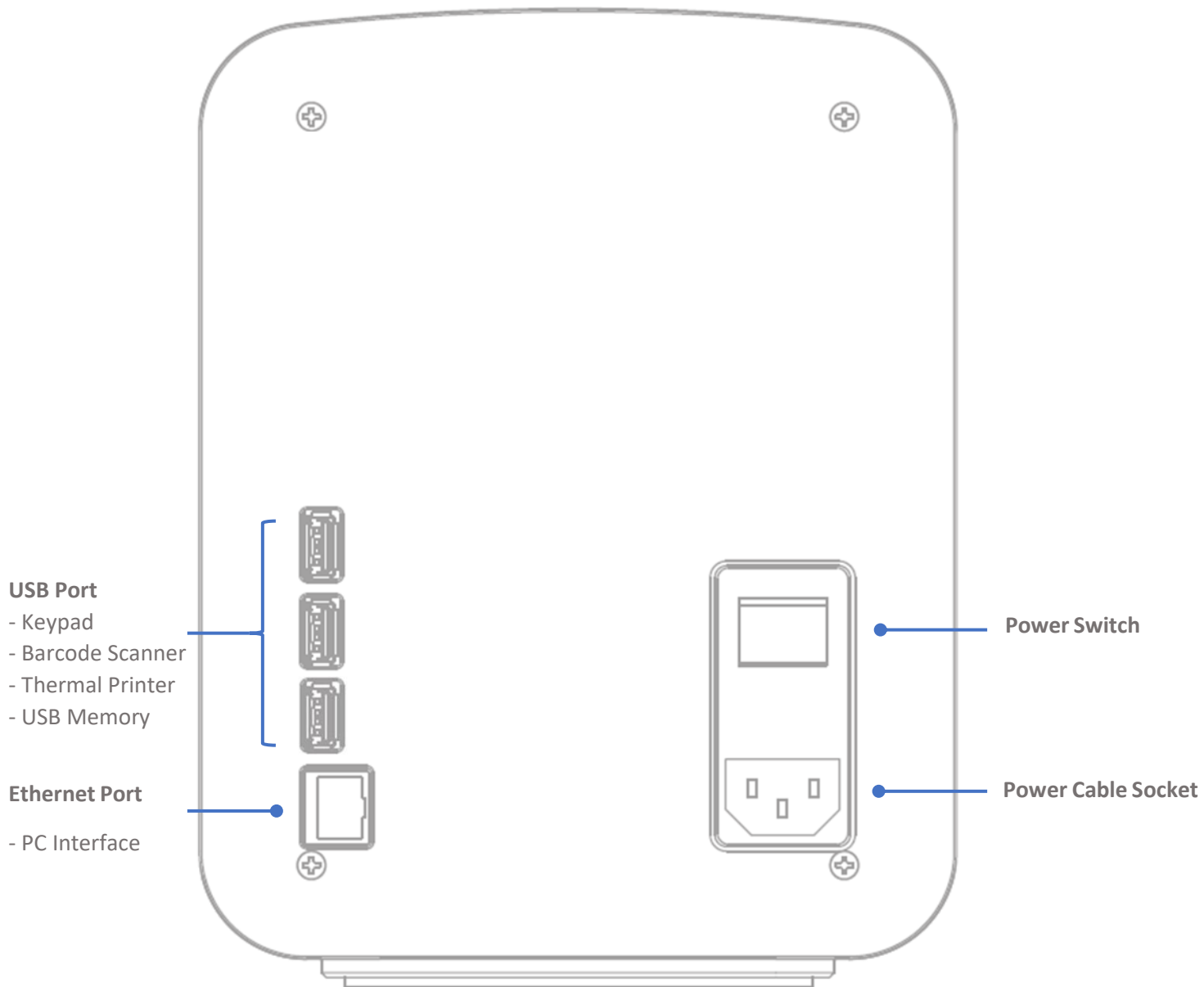

Rear view

- **3 USB ports** – Keypad, Barcode scanner, Thermal printer (optional), or USB memory are connected to these ports.
- **Ethernet port** – LAN cable is connected to this port for PC interface.
- **Power switch** – Main device power ON/OFF control.
- **Power cable socket** – Power cable is connected to this socket.

Table of contents

Package contents	3
Safety instruction	4
Product specifications	5
Device overview	6
Introduction	
QuadCount™– Automatic cell counter	10
QuadSlides™ (50 slides for 200 tests per a box, Cat. No. E5750-S1)	11
Getting started	
Pre-requirements	12
Basic installation	13
Power up and initial display	14
General operation	
Sample preparation	15
Basic operation	16
Preview prior to counting	18
Stopping while counting	20
Set counting option	21
A. Changing user group	22
B. Setting Count mode	23

C. Creating a Preset	24
D. Editing a Preset	27
E. Selecting Channels	29
F. Entering a Channel ID	30
The result screen	35
A. Analyzing by Histogram	36
B. View results images	38
C. Printout Cell Count Result using Thermal Printer	40
D. Exporting the Report to a USB memory stick	41
E. Exporting Data (all history) to a USB memory stick	43
F. Showing channel ID names	46
Setting screen	47
A. Checking Firmware information and Updating Firmware	48
B. Bead Quality Control	50
C. Setting Date and Time	52
Maintenance and cleaning	54

Appendix

A. Trouble shooting	55
B. Examples of errors and inaccurate results	56
C. The contents of result data exported as a .csv file	58
D. Example and explanation of PDF report	59

Introduction

QuadCount™– Automatic Cell Counter

The QuadCount™ is a fully automated cell counting system based on a brightfield microscopy technique for mammalian cell counting. The QuadCount™ utilizes a high-powered LED light source, CMOS image detection (5 Mega pixels), precise X-Y-Z stages and on-slide image processing technologies for fast and accurate cell analysis.

Cell counting using the QuadCount™ requires 3 main steps, (1) cell staining, (2) loading sample slide, and (3) counting. Cells are mixed with trypan blue dye to distinguish between live and dead cells. The stained sample is pipetted into the disposable plastic slide (4 tests per slide) and the slide is loaded into the QuadCount Instrument. After loading the slide, the optic system automatically focuses on the slide and the instrument acquires and analyzes the images automatically. The precise X-Y-Z stages move through the preset routes to take multiple images for each channel. A highly sensitive CMOS sensor acquires bright-field microscopy images and sends them to the integrated system for image processing and analysis. The whole counting process takes 2 minutes (in Normal mode) and the counting results are displayed on the LCD touch screen panel on front of the instrument.

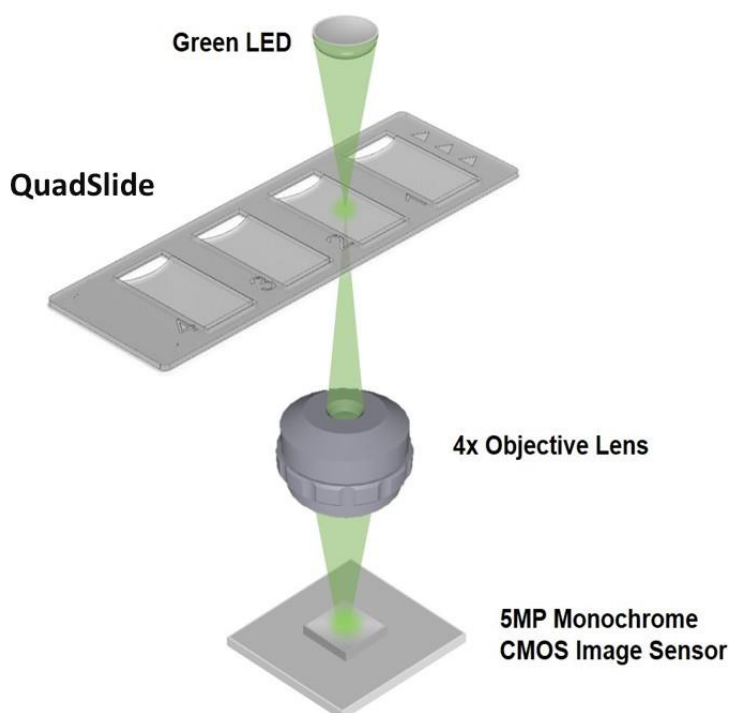

QuadSlides™ Slides (50 slides for 200 tests per a box, Cat. No. E7500-S1)

The QuadSlide™ is a disposable plastic hemocytometer that includes 4 sample channels engraved with Neubauer Improved pattern. Each channel has an enclosed structure of 100um depth and a hydrophilic surface. The precise capacity and diffusible surface ensures that cells are evenly distributed and this ensures accurate analysis. QuadSlides™ can be used for mammalian cell counting with the QuadCount Instrument, but can also be used for manual counting methods. The measuring range of cell concentrations is $1 \times 10^4 \sim 1 \times 10^7$ per mL when used with the QuadCount Instrument.

Cell Counting: prepare a cell suspension for counting and mix the cell suspension with trypan blue at a one to one ratio. Each channel of a QuadSlide™ is filled with 20 μ L of mixture and is then loaded into the QuadCount™ Instrument. After the analysis is complete, the results will be displayed.

Keep QuadSlide™ boxes upright and at room temperature. Each individual slide should be used immediately after opening the individual sealed package. Follow the exact procedure detailed in the *Instructions for Use* section.

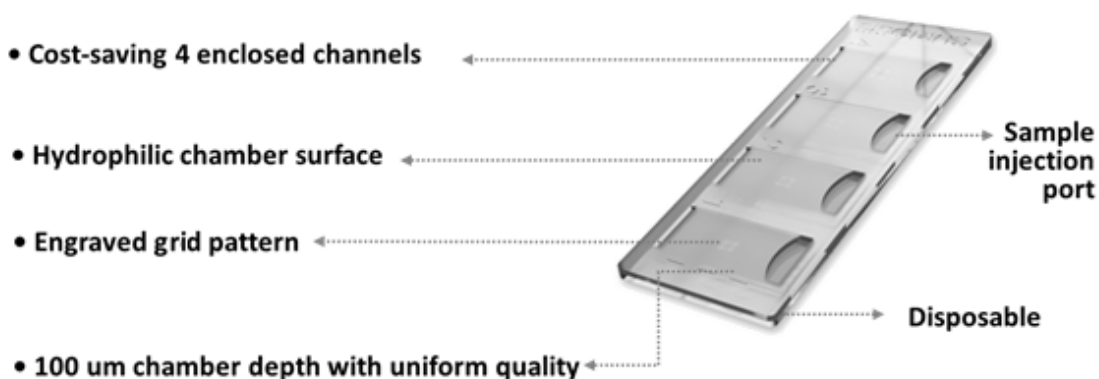

Getting started

Pre-requirements

For normal and stable operation of the device, the following environmental conditions should be met.

- Room temperature between 20 ~ 35 °C (68 to 95 °F)



*It is not recommended to operate the device at low temperature condition (below 10 °C)
In cold conditions, warm up the device for a minimum of 10 minutes before use.*

- Relative humidity between 0 ~ 95 %.
- Install in a location free of corrosive gases or other corrosive substances.
- Install in an area free of dust or other airborne particles.
- Avoid direct sunlight, vibration, and close proximity to magnetic or electromagnetic fields.
- Do not place any heavy objects on the top of the device.

Basic installation



1. Unbox the QuadCount™ and place the device on a flat, level and dry surface.

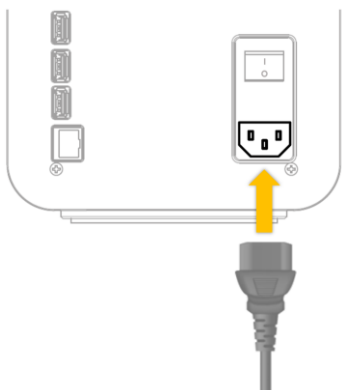

2. Plug accompanying power cable into the power cable socket.

Peripheral
- Keypad
- Barcode Scanner
- Thermal Printer
- USB Memory

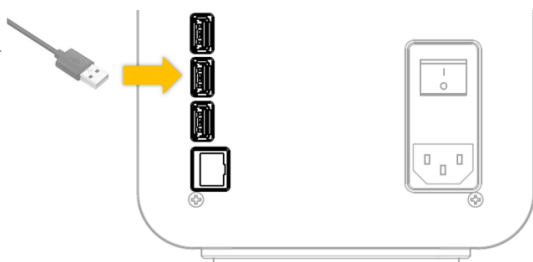

3. Connect any optional peripherals (keypad, barcode scanner, or thermal printer) to the USB port if desired.

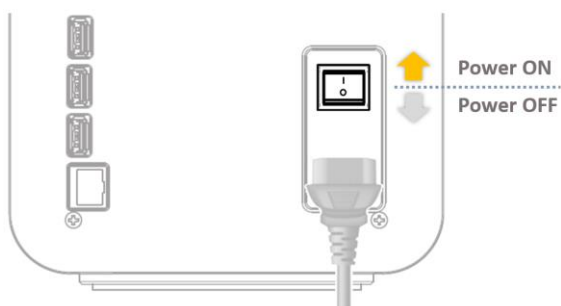

4. Plug the power cable into an appropriate rated wall outlet and press the power switch to ON.

Check that the main power switch is in I (ON) position.

Power up and initial display



1. Once the main power is switched on, the boot image is displayed on the LCD touch screen. When booting is completed, the initializing process starts and internal motorized stages start moving.



2. Initializing progress is displayed while processing.

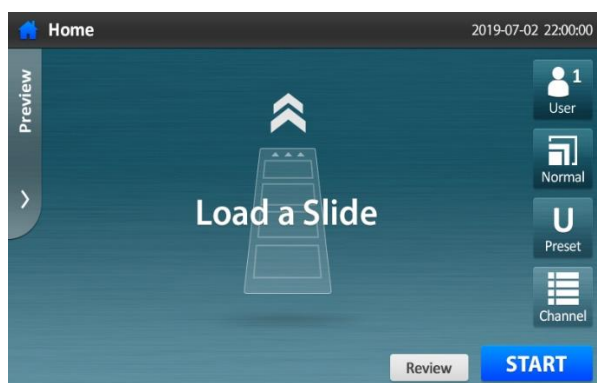

3. When initializing is finished, the slide holder is ejected, and Home screen is displayed on the LCD touch screen.

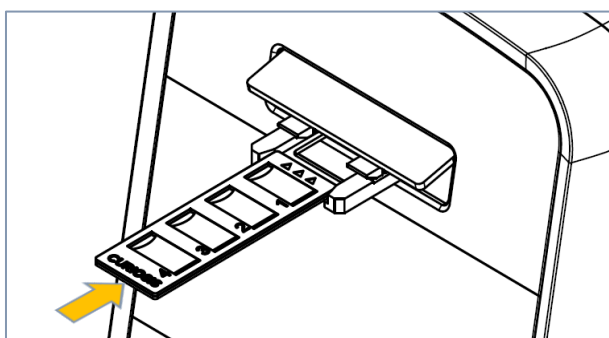

4. After loading a slide with sample, the device is ready to count.

General Operation

Sample Preparation

Required materials: Cell suspension, 0.4% trypan blue, micro tube 1.5ml, pipette, tips, and QuadSlides™. Preparation should be done in a clean area to avoid dust contamination (dust on the slides or in the samples will greatly reduce counting accuracy).



STEP 1. Prepare necessary items.

STEP 2. Place 20 μL of trypan blue in the micro tube and add an equal volume of the cell suspension.

NOTE: Before sampling the cell suspension, gently resuspend the cells at least 6 times (pay attention to avoid bubbles and check if there are any cell clumps or agglomerates) The sampling should be in middle of the cell suspension, not on the surface or the bottom.

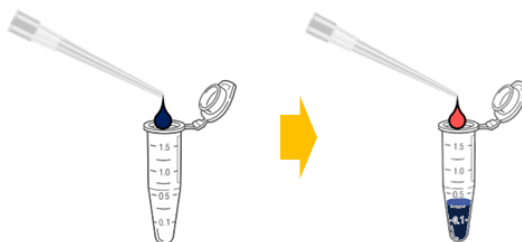

STEP 3. Mix the sample in the micro tube by pipetting the vial 3~5 times gently.

NOTE: Be careful not to create bubbles.



STEP 4. Load 20 μL of the stained cell sample into each channel of a QuadSlide™.

NOTE: The samples should be from the middle of the cell suspension, not from the surface or the bottom, and ensure that no bubbles enter the slide channels.

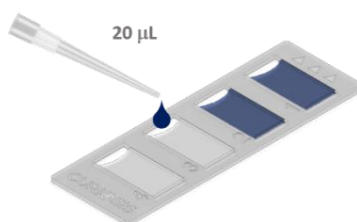

Basic Operation

STEP 1. Insert a QuadSlide™ loaded with the samples into the slide holder.

NOTE: Make sure the arrow on the slide points toward the instrument.

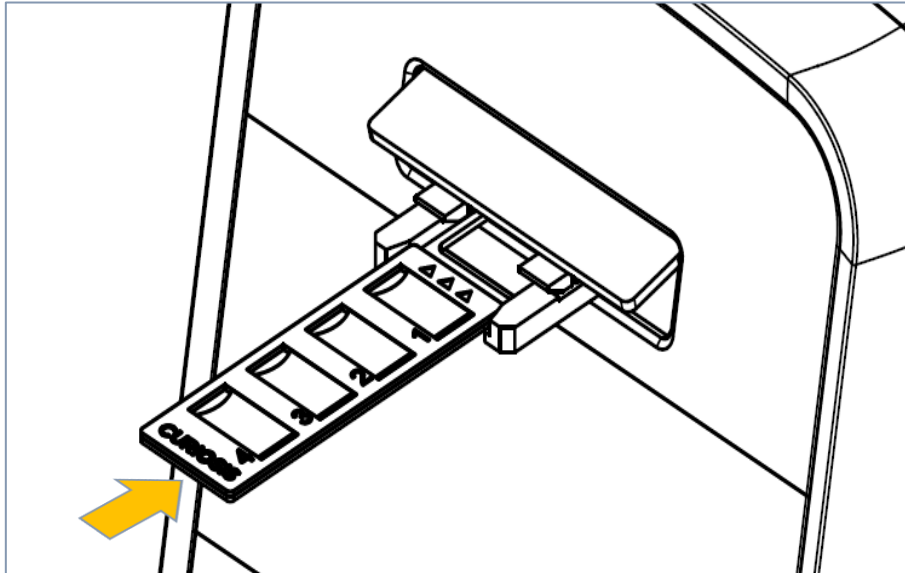

STEP 2. Press **Start** button to start counting procedures. The slide holder will retract automatically, and auto-focusing is performed prior to counting each sample.

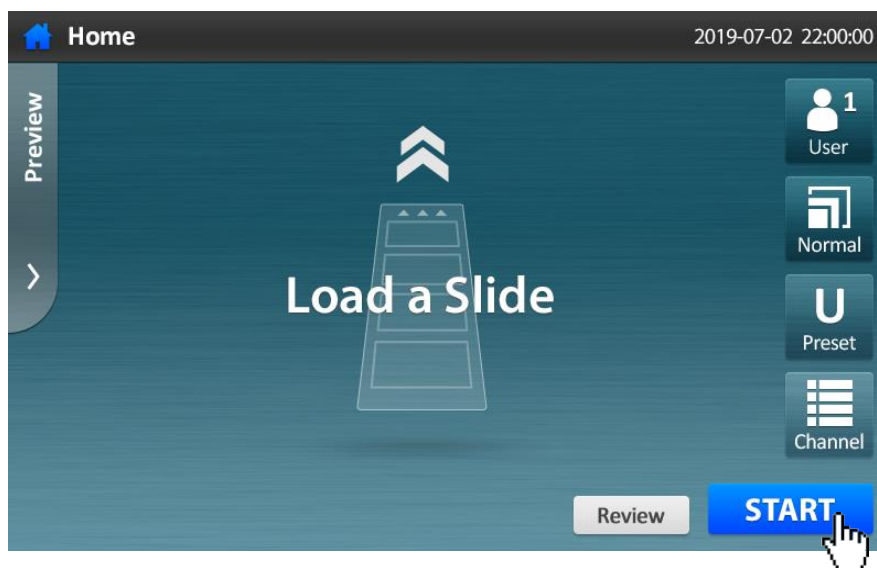

STEP 3. The counting progress is indicated as shown in following image. For completion of each sample, the count results (unit: $\times 10^4/\text{mL}$) are displayed.

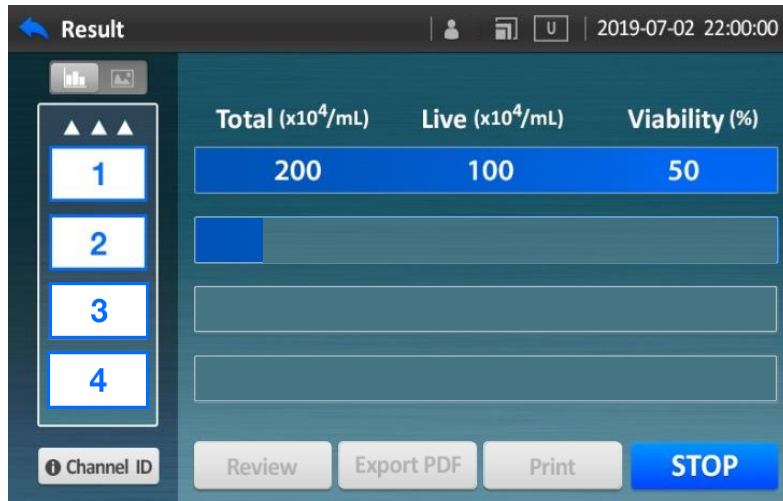

STEP 4. Once counting is complete, the slide holder is ejected automatically. Remove the QuadSlide™ from the slide holder.

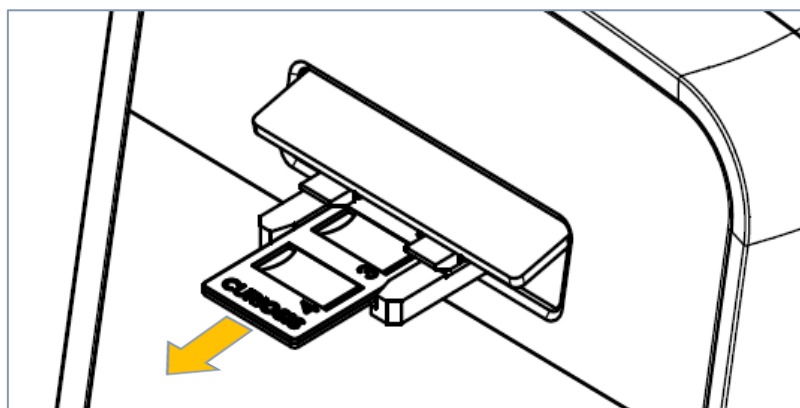

Preview prior to counting

- ! On the screen where you can see the cells, tap the screen twice to make the icons disappear. To get icons back again, tap the screen twice.

STEP 1. Load a slide and press **Review** button.



STEP 2. Select a channel to preview.



STEP 3. Positioning and Autofocusing happens automatically

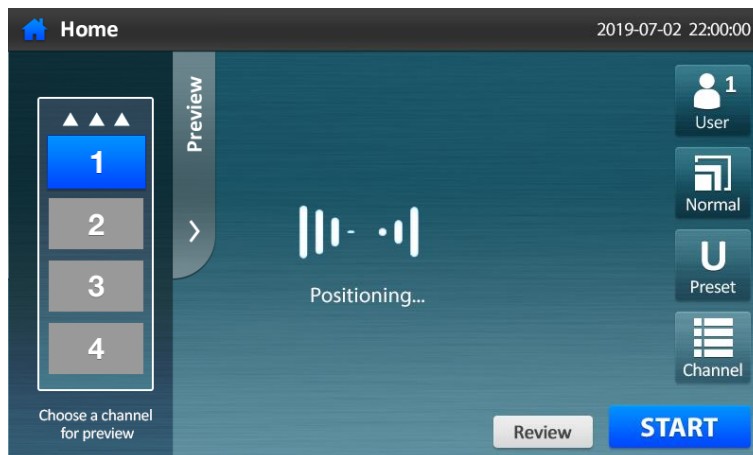

STEP 4. See the cell image of the selected channel.

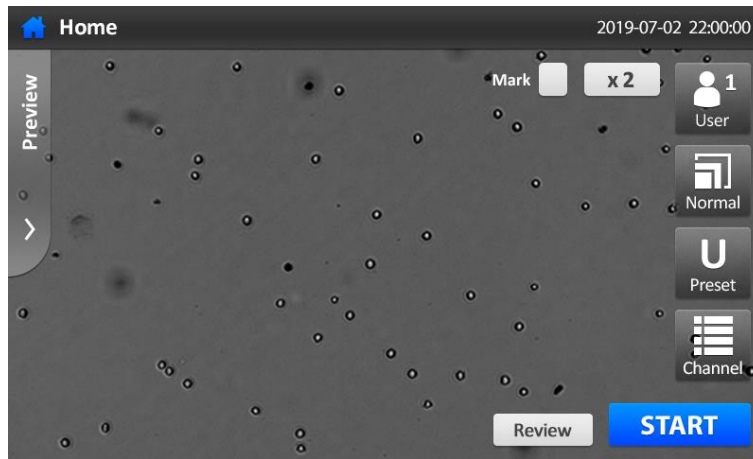

STEP 5. Press **Mark** , and the detection mark is displayed. **Live/Dead definition** can be modified at this stage.



STEP 6. Counting

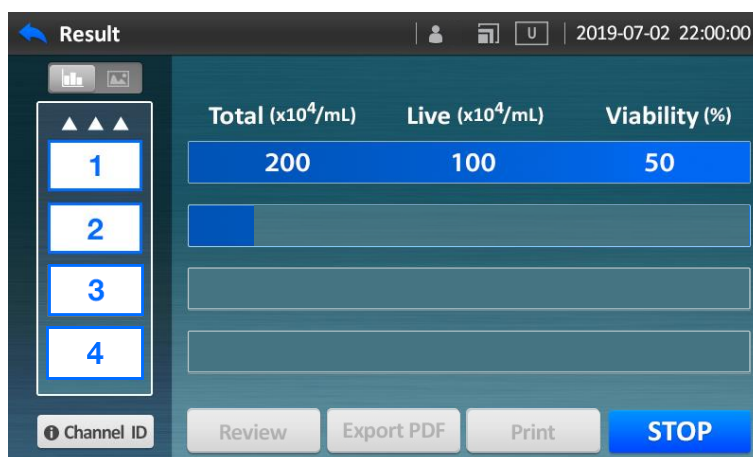

Stopping While Counting

STEP 1. To stop the instrument during counting, Press the **STOP** button.

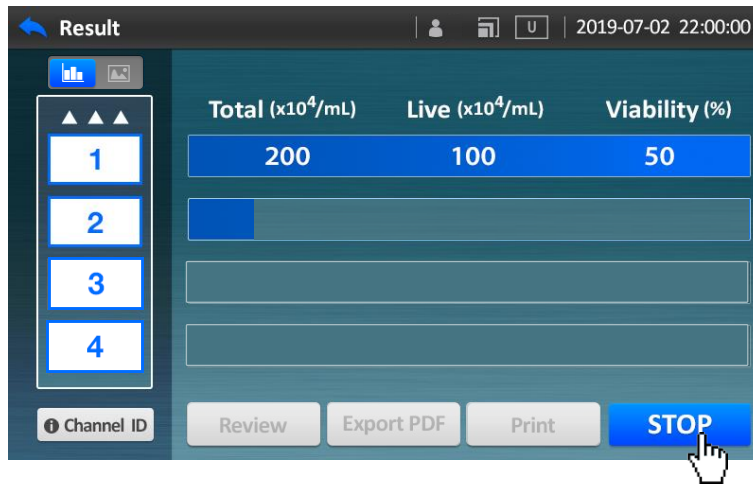

STEP 2. A confirmation message box is displayed as shown the following image. Press the **Continue** button to confirm stopping.

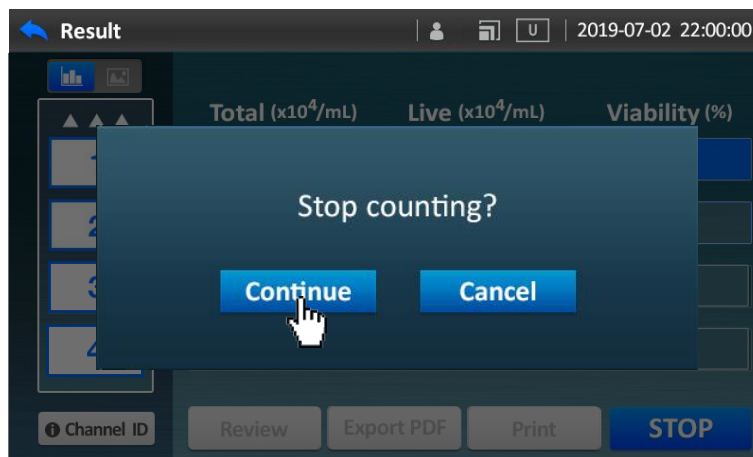

STEP 3. Once stop counting is confirmed, all remaining processes are stopped, and the slide holder is ejected automatically.

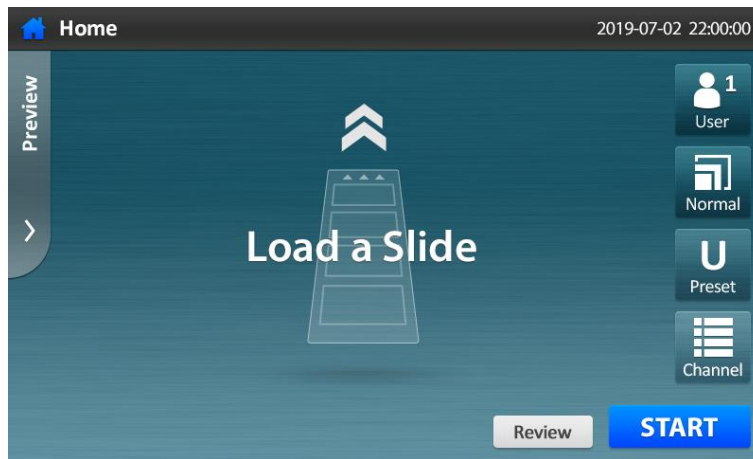

Set counting options

The following operations can be performed from the Home screen.

Setting options for counting



User : 1/2/3

Auto-saved data and presets can be managed per user.



Count mode : Quick/Normal/Precise

Total counting area (number of snapshots) is different for each count mode.

Quick mode: $\approx 0.15 \mu\text{L}$ (1 Frame)

Normal mode: $\approx 0.9 \mu\text{L}$ (6 Frames)

Precise mode: $\approx 3.6 \mu\text{L}$ (24 Frames)



Presets

User-changeable parameters for cell recognition

There are 3 kinds of fixed presets



Channel

Decide channels to be measured

White box: enabled channel

Gray box: disabled channel

Press a channel to toggle between enabling and disabling.

A. Changing User Group

The QuadCount™ provides personalized history of results to user groups (1,2 and 3). The user group is useful to manage user presets and numerous results autosaved after counting. The auto-saved results (review screen) are accessible only to the user group that was active at the time the results were captured.

Note: Review and User preset list depends on User group. Therefore, before selecting user preset or pressing review, check the user group.

Step 1. Press the **User** button.



Step 2. Select the **User 1/2/3**.



B. Setting the Count mode

The QuadCount™ provides three counting modes (Quick/Normal/Precise mode) according to the counting area. The QuadCount™ is designed to capture multiple frames per channel using an XYZ stage. Each single image frame covers a volume of 0.15 µL. The more pictures taken, the higher the accuracy of results.

 Select the count mode depending on requirements, refer to the following table.

Count mode	the number of frames captured per a channel	Analyzed volume	Counting time per chamber	Application requirement
Quick mode	1	0.15µL	≤ 20s	When you want to get a result quickly and make a rough estimate of cell numbers.
Normal mode (default)	6	0.9µL	≤ 30s	When you want to get results with reasonable accuracy and speed (such as general subculture procedure)
Precise mode	24	3.6µL	≤ 100s	When you require precise results or count cells from a low concentration sample.

NOTE: if the cell concentration is less than 5×10^4 cells/ml, Precise mode is recommended.

STEP 1. Press the Count Mode button.



STEP 2. Select the Count mode.

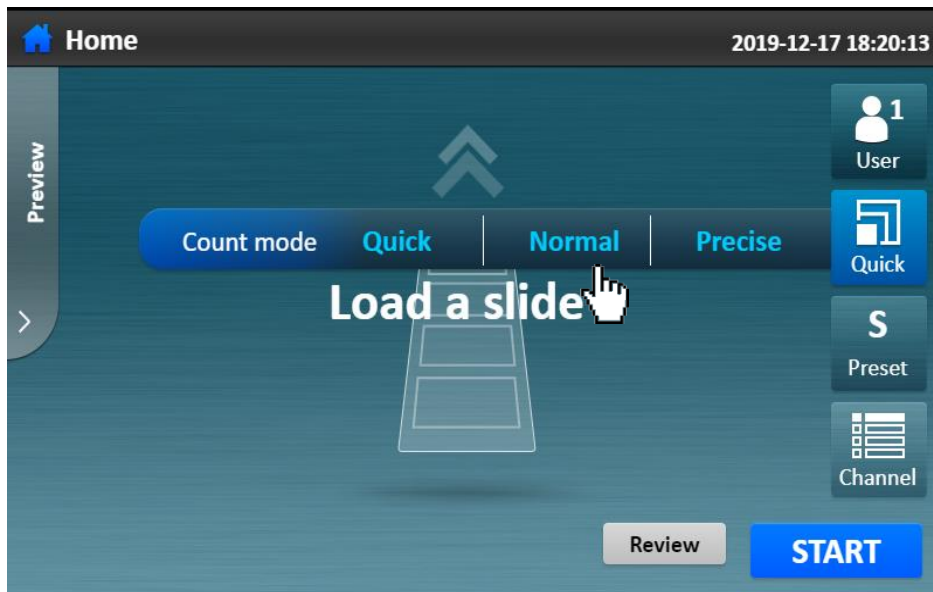

NOTE: The setting is applied to all enabled channels.

C. Creating a Preset

- ! Users can manage **User Preset** items. (5 User presets are available per User group)
- ! The 3 fixed presets cannot be removed or edited.

STEP 1. To create your own preset, press Preset button.

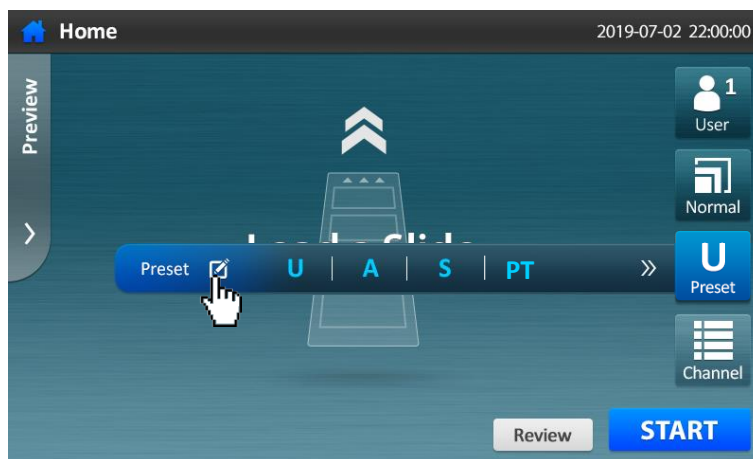

STEP 2. Press Plus button.



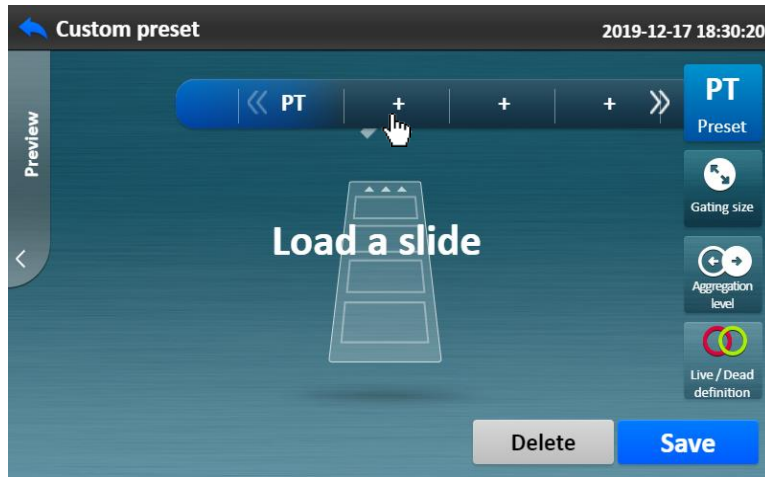

STEP 3. Select one of 3 fixed presets (Universal, Small, Angular), and press the blank text box beside **Index**.

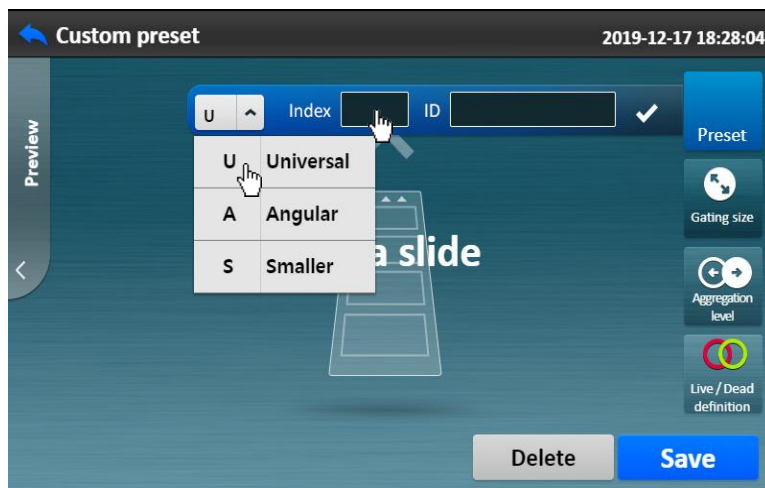

STEP 4. Type the names of **Index** and **Preset ID**.

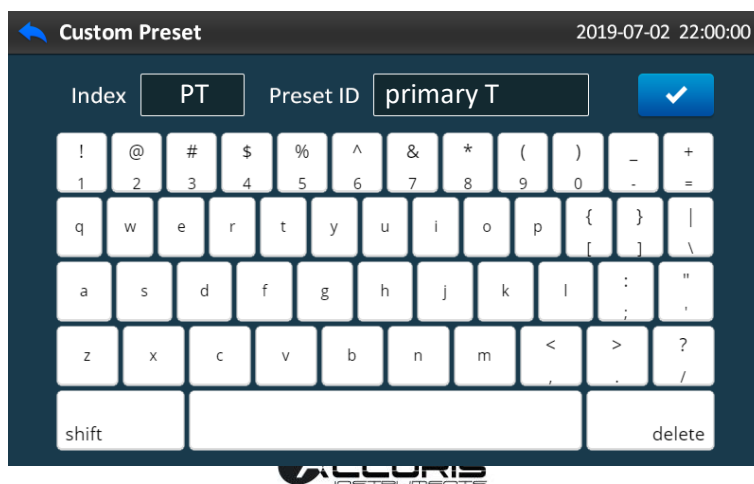

STEP 5. Adjust the 3 parameters according to requirements.

(Gating size, Aggregation level, Live/Dead definition).

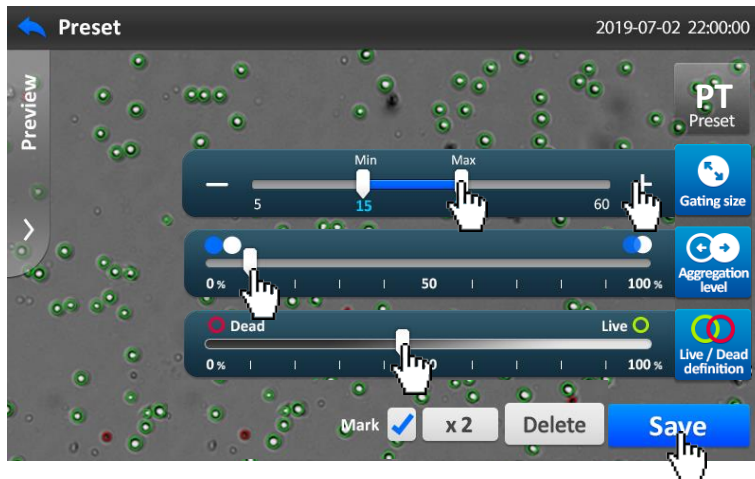

STEP 6. Ready to count with a customized preset.



D. Editing a Preset

STEP 1. To edit your own preset, press **Preset** button. 

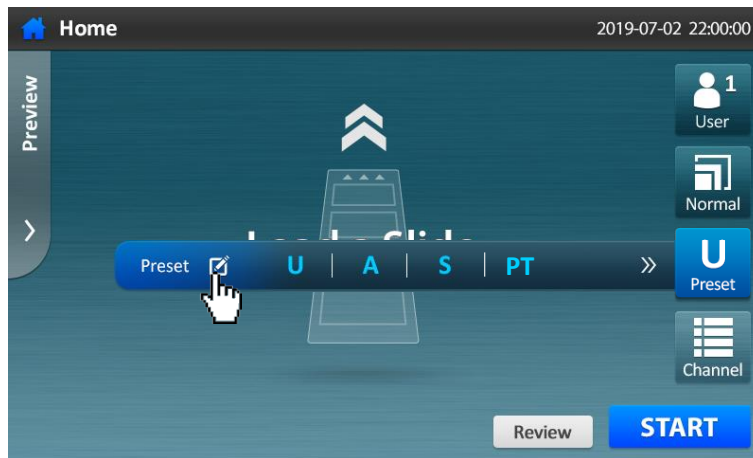

STEP 2. Select the preset button which you created.

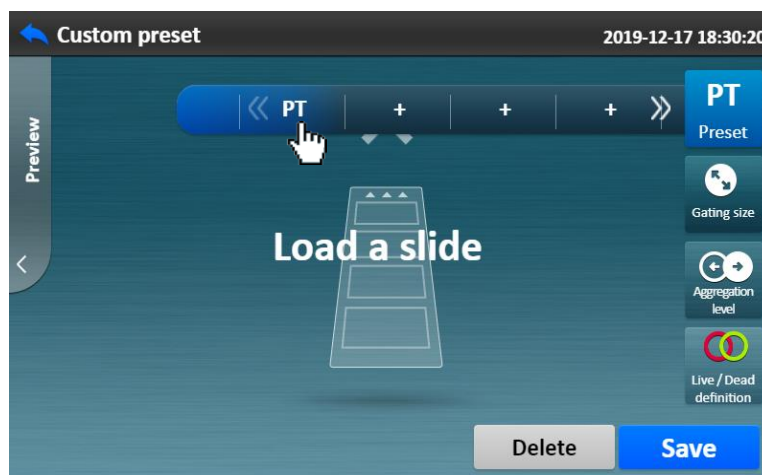

STEP 3. Adjust the parameters of your preset.

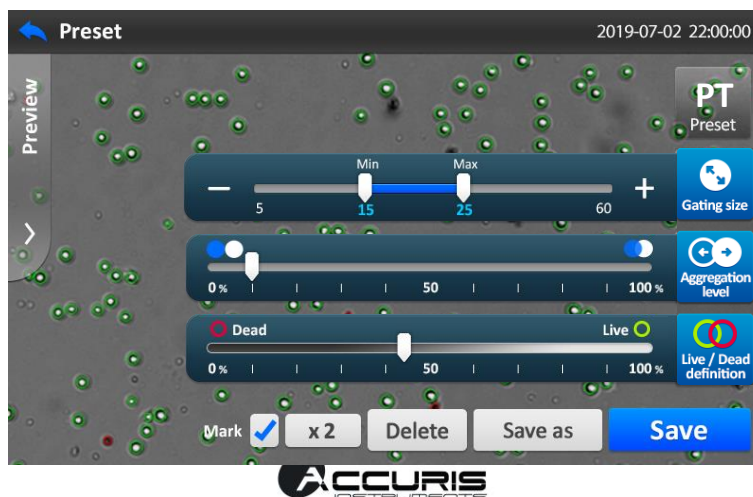

STEP 4. Press the **Save** button to keep the changed parameters.

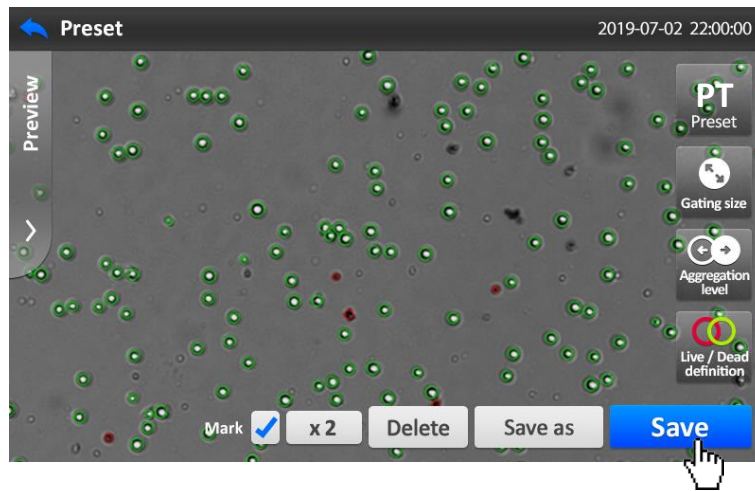

STEP 5. To delete your own preset, press **Delete** button.



E. Selecting Channels

Four channels in the QuadSlide™ can be individually enabled or disabled.

STEP 1. Press the **Channel numbers** to be disabled/enabled. (Disabled: Gray box, Enabled: White box)



STEP 2. Press the **Start** button to count immediately.



F. Entering Channel ID

Naming/Identifying a channel can be accomplished with the Channel ID option. Select “Channel ID” as shown below and enter the desired channel name. (The name might often be the specific cell type.)

The ID can consist of a maximum of 20 alphanumeric characters and some special characters.

STEP 1. Press **Channel ID** button.



STEP 2. Choose a desired channel (1 through 4).

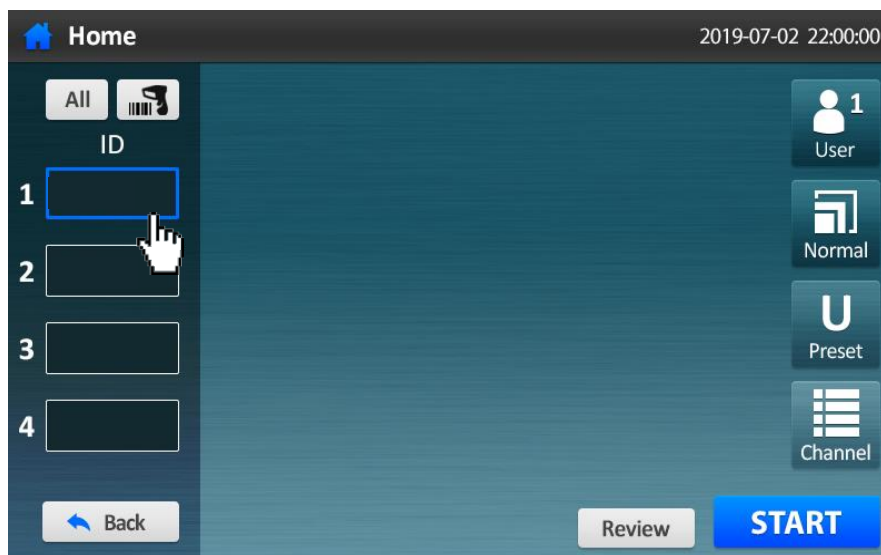

STEP 3. Type the desired names for each **Channel**.

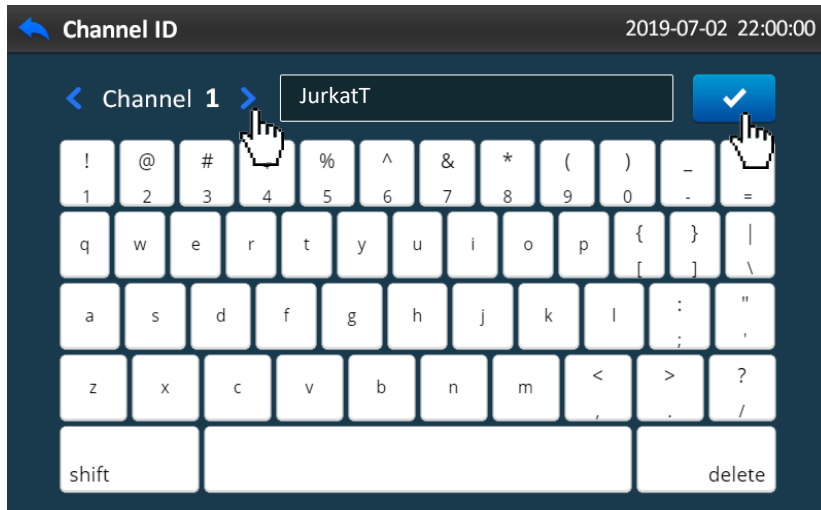

STEP 4. Press **Back** button.

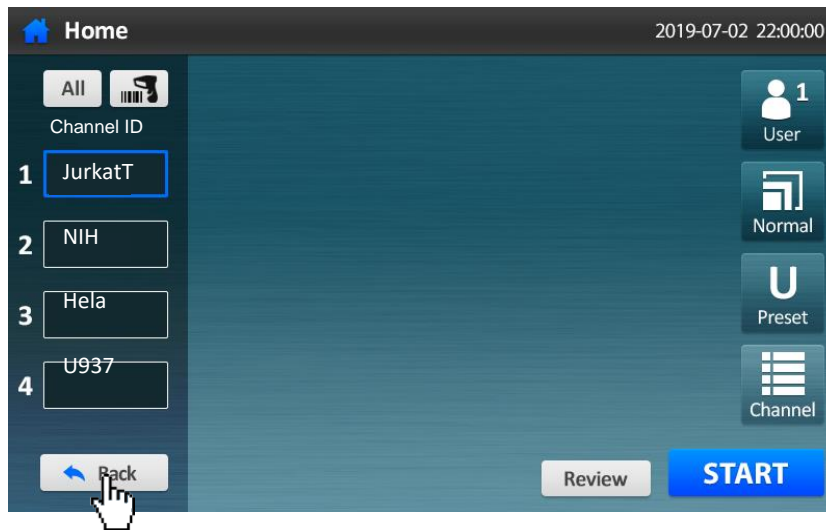

STEP 5. Ready to count.



- To fill in all channel IDs for the same cell type

STEP 1. Press **All** button.

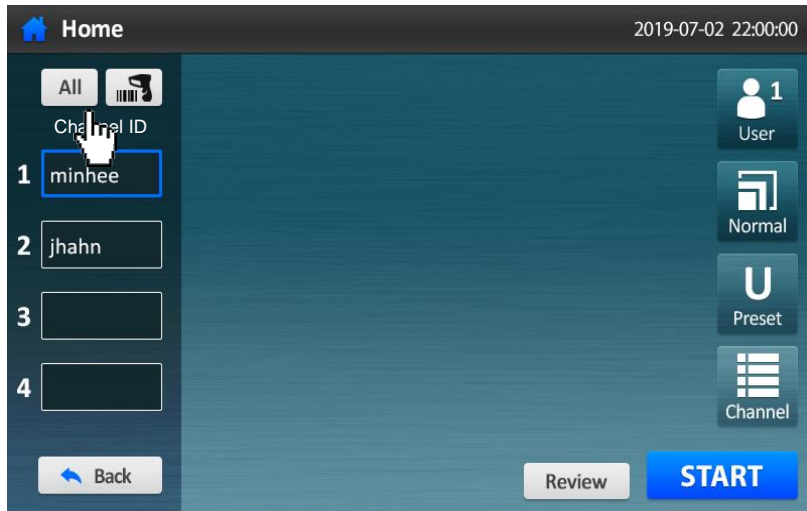

STEP 2. Enter the desired name (or cell type and press **OK** button.

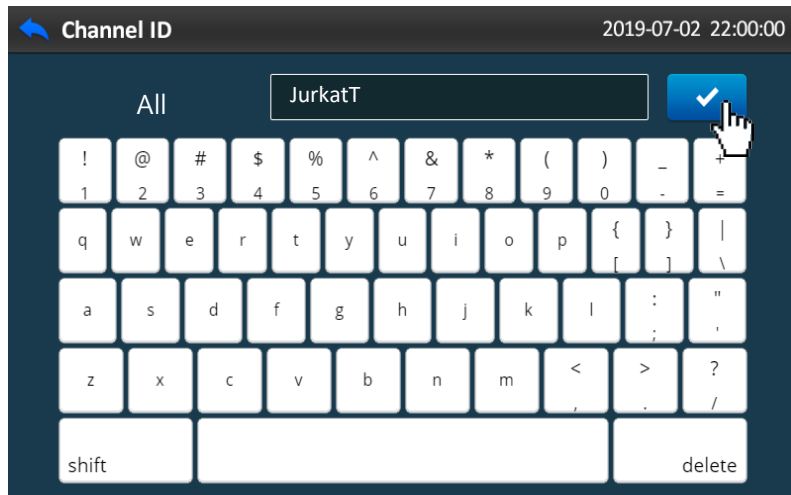

STEP 3. Confirm that the ID has automatically populated for all 4 channels, then press **Back** button.



- **Using accessory input devices: barcode scanner, USB keypad or USB keyboard (optional)**



Keypad and barcode scanner are optional. Contact your local distributor if required.



Connect the input device to the USB port on the back side of the device. When properly connected and recognized, an icon appears on the status bar.

Input Device	Usage
Keypad	1. Enter a channel ID and press the “ Enter ” key 2. The cursor moves to the next channel ID box (The direction key can also be used to move the cursor.)
Barcode Scanner	1. Scan a barcode containing channel ID name. 2. The Channel ID box is filled with corresponding ID name, and the cursor moves to the next box when entered successfully.

STEP 1. Connect the keypad or barcode scanner via the USB port at the back side of the QuadCount.

Check if  icon is present at the top. Press the **Barcode scanner** button above the channel ID boxes.

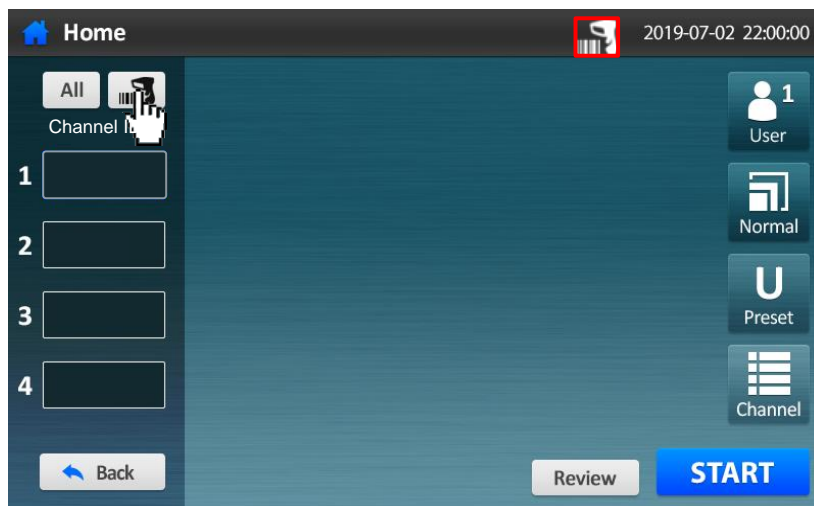

STEP 2. Touch the top blank text box and enter 4 channel IDs using the connected keypad or the barcode scanner (refer to the above table). The maximum channel ID length is 20 alphanumeric characters or some special characters.

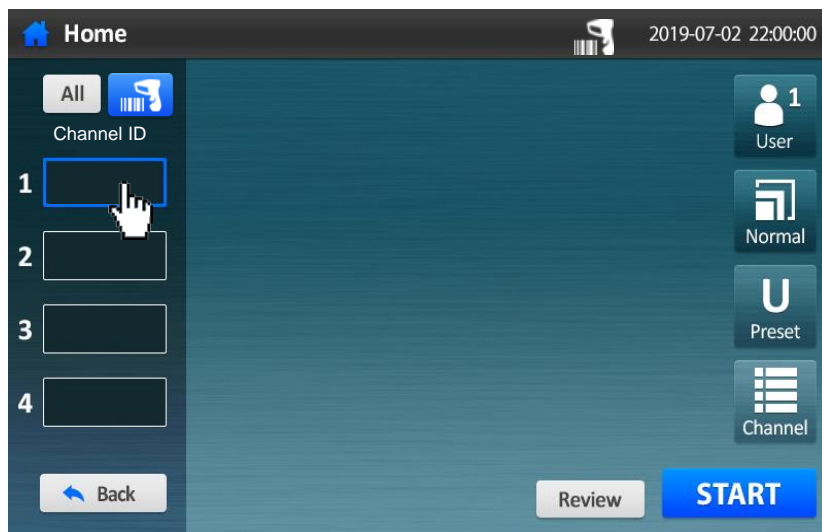

STEP 3. Confirm that up to 4 channel IDs boxes are correctly filled, then press the **Back** button.

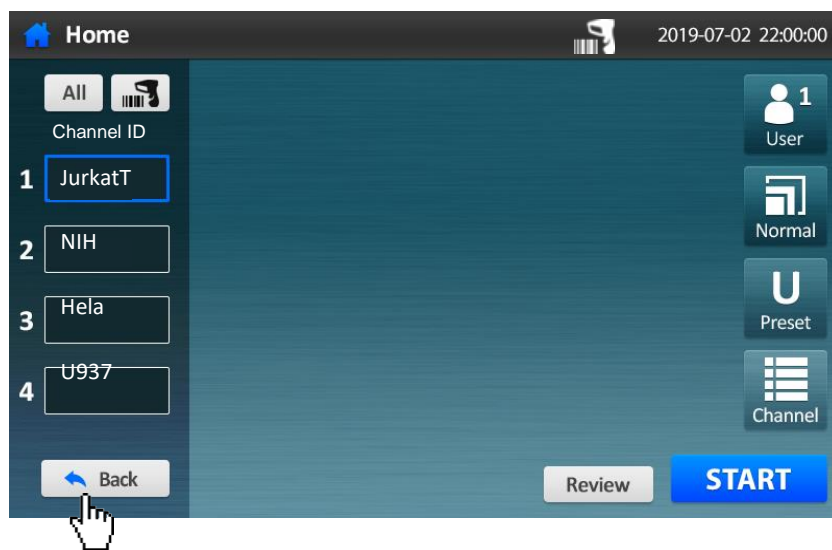

The Result screen

The following operations are performed on the result screen after counting.

After completing the cell counts, histograms of cell size distribution and result images are provided. While viewing histogram, it is possible to modify cell size gating parameters. The QuadCount™ can generate both histograms for individual channels and also a combined histogram of all channels.



 *The QuadCount™ can detect 5 ~ 60µm diameter objects. However, the gating system is set by default to count from 8µm because most common cell lines have a size starting at or above 8µm.*

NOTE: If you want to count cells smaller than 8 µm, change the cell size gating parameter in the histogram.

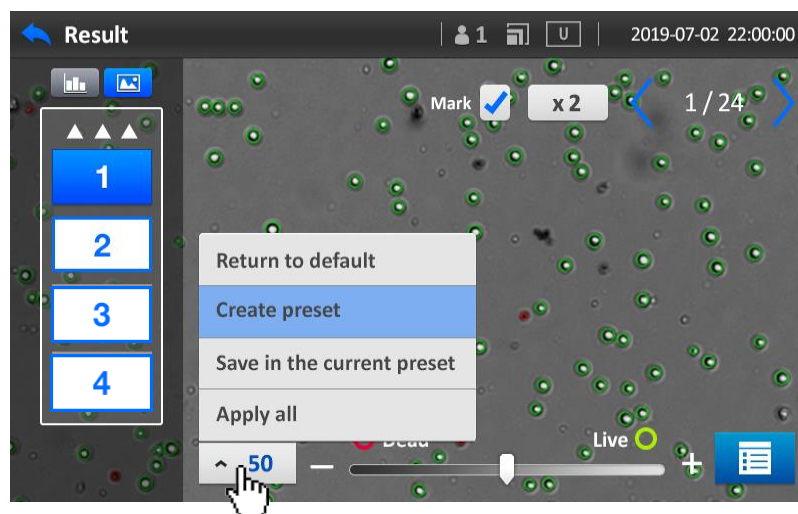
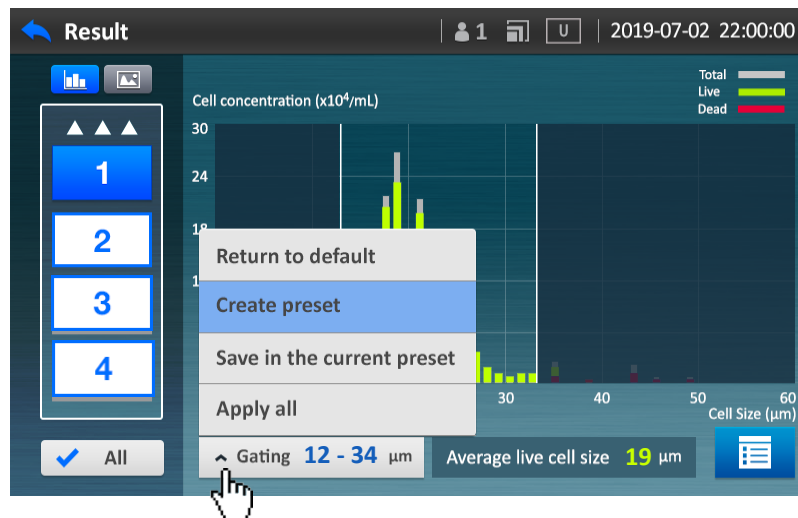

Toggle between the histogram and result image after selecting a channel.



- Press  or  button to see the result images of selected channels.
- **Return to default** : The changed settings return to the default settings.
- **Create preset** : The adjusted settings can be saved as a new preset.
- **Save in the current preset** : The changed settings can be saved in current preset (This is not available in a fixed preset).
- **Apply all** : The changed settings is applied to all channels.

A. Analyzing by Histogram

STEP 1. Press a **channel** number to check, and switch to the **histogram** icon. 

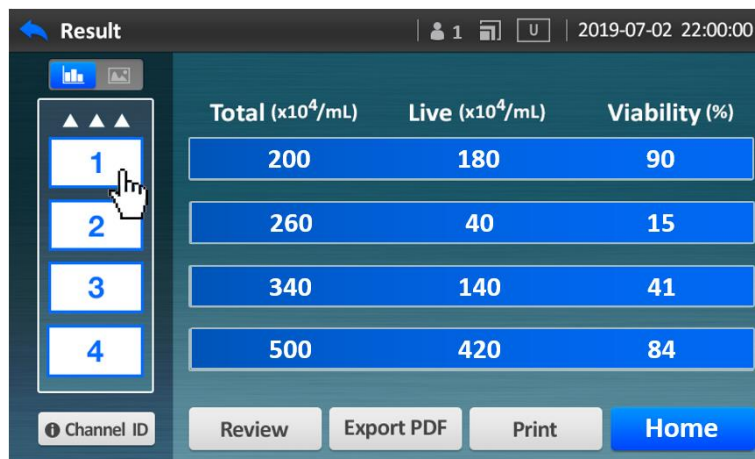

STEP 2. Press **All** to view the average data of all channels.

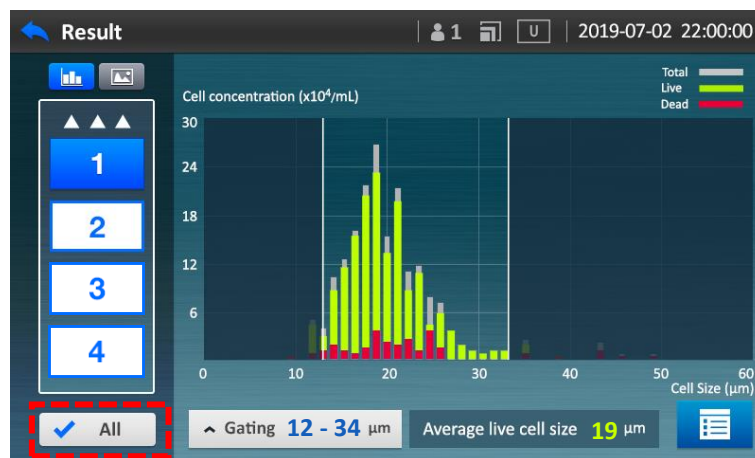

STEP 3. Move both columns and adjust the cell size gating.

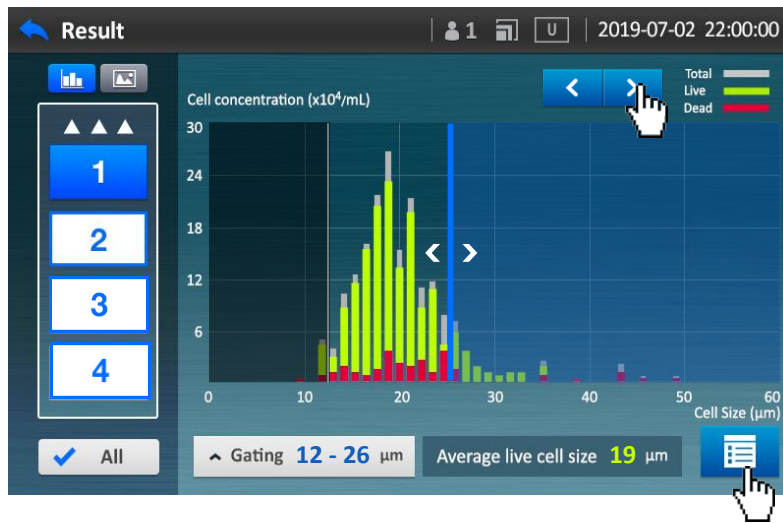

STEP 4. Check the results table of total cells, quantity of live, and viability %.

	Total ($\times 10^4/\text{mL}$)	Live ($\times 10^4/\text{mL}$)	Viability (%)
1	180	167	93
2	260	40	15
3	340	140	41
4	500	420	84

Buttons: Channel ID, Review, Export PDF, Print, Home

B. View Results Images

The QuadCount™ provides the results images after counting. One or more images are acquired and analyzed per channel, and the number of images depends on the count mode selected. The “Result image” screen shows the analyzed images with live cells circled in green and dead cells circled in red.

STEP 1. Press a **channel** which you want to check, and switch to the **Image** icon. 



	Total (x10 ⁴ /mL)	Live (x10 ⁴ /mL)	Viability (%)
1	200	180	90
2	260	40	15
3	340	140	41
4	500	420	84

Buttons: Review, Export PDF, Print, Home

STEP 2. Adjust Live / Dead cell definition.

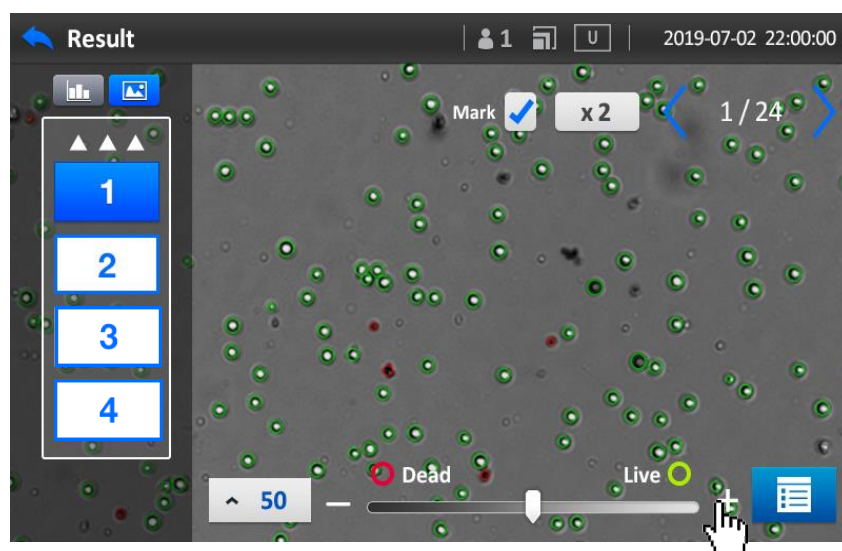

STEP 3. Press Data icon. 

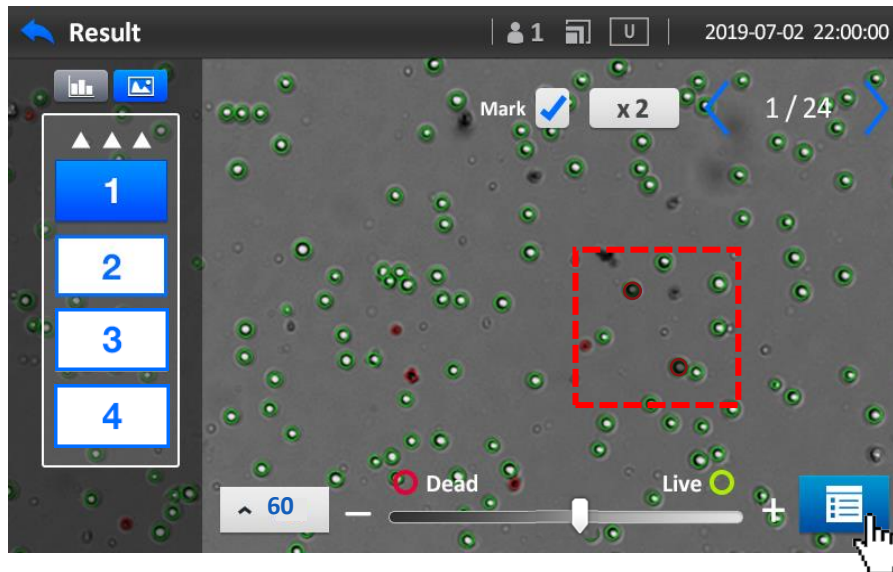

STEP 4. Review the number of Live cells and Viability %.

The screenshot shows a table of cell counts and viability percentages. A red dashed box highlights the Live (x10⁴/mL) and Viability (%) columns.

	Total (x10 ⁴ /mL)	Live (x10 ⁴ /mL)	Viability (%)
1	200	166	83
2	260	40	15
3	340	140	41
4	500	420	84

C. Printout Cell Count Results using a Thermal Printer

The QuadCount™ can use a thermal printer to printout the counting result.

 *The Thermal printer is optional. Contact Accuris Instruments or your local distributor for ordering information.*

Step 1. Connect the thermal printer to the USB port at the back side of the device.

Confirm that the  icon is present on the status bar, indicating that it is recognized.

Press **Print** button.

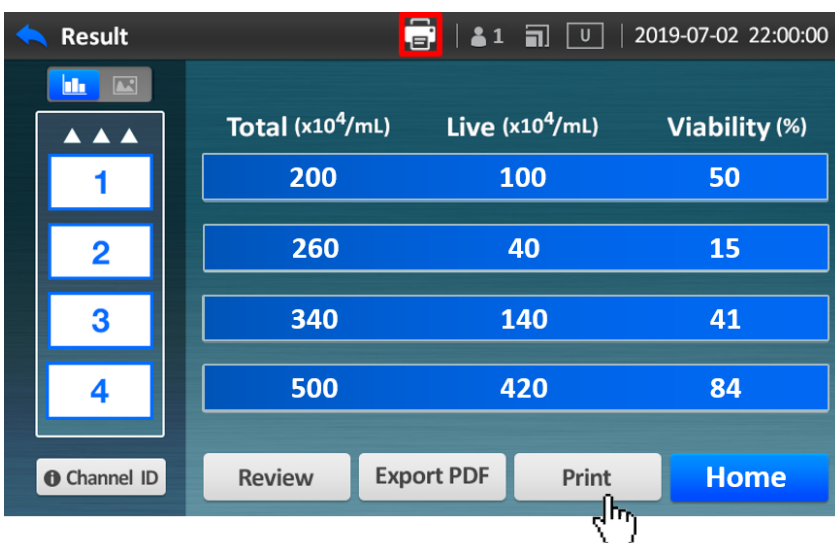

	Total (x10 ⁴ /mL)	Live (x10 ⁴ /mL)	Viability (%)
1	200	100	50
2	260	40	15
3	340	140	41
4	500	420	84

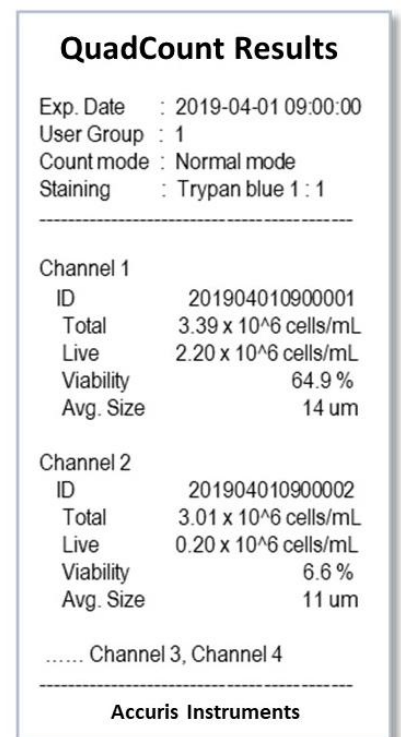

QuadCount Results

Exp. Date : 2019-04-01 09:00:00
User Group : 1
Count mode : Normal mode
Staining : Trypan blue 1 : 1

Channel 1
ID : 201904010900001
Total : 3.39 x 10⁶ cells/mL
Live : 2.20 x 10⁶ cells/mL
Viability : 64.9 %
Avg. Size : 14 um

Channel 2
ID : 201904010900002
Total : 3.01 x 10⁶ cells/mL
Live : 0.20 x 10⁶ cells/mL
Viability : 6.6 %
Avg. Size : 11 um

..... Channel 3, Channel 4

Accuris Instruments

Example

D. Exporting a Report to a USB memory stick

A report of the counting results can be exported as a PDF to a USB memory stick. The PDF report shows general information, the cell image and the histogram of cell size distribution.

! Please use the USB memory stick included with the QuadCount™ or another that is formatted to FAT32 or NTFS file system. USB memory sticks formatted to the ex-FAT file system is not supported.

If an ex-FAT File system memory stick is connected, the USB memory icon will display, but an error message "Unsupported USB memory" will appear when trying to export data or a report.

Step 1. Connect the USB memory stick to the USB port on the back side of the QuadCount.

Confirm that the  icon is present on the status bar, indicating that it is recognized.

Press the **Export PDF** button.

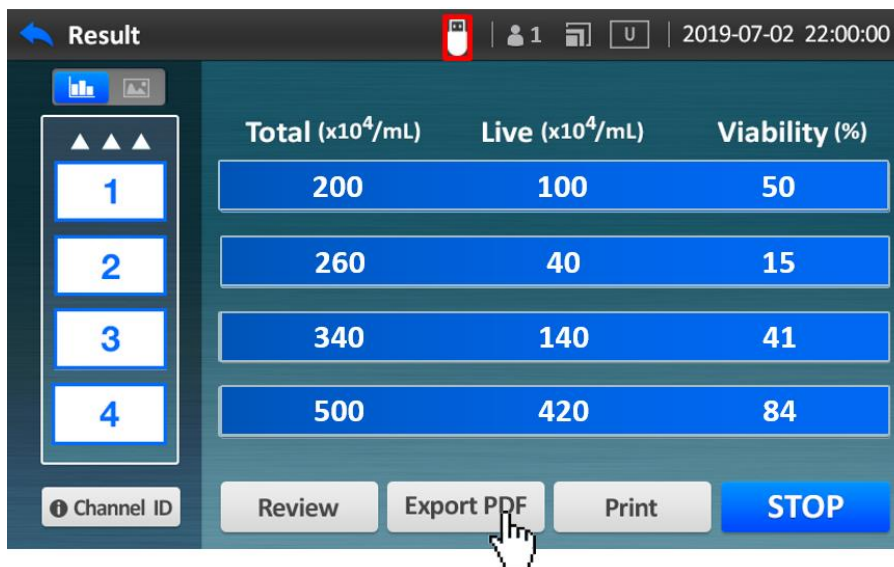

Step 2. A progress dialog box appears to indicate that exporting the report is in progress.

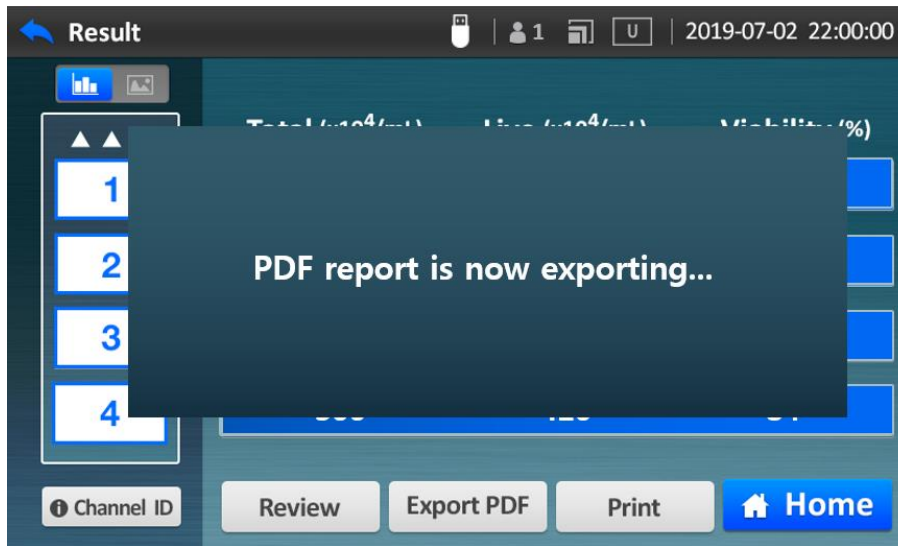

Step 3. Once the progress dialog box disappears and the notification message (“Export success”) is displayed on status bar, you can remove the USB memory stick from USB port.

NOTE: If the USB memory stick is removed before the “exporting” message disappears, the results file may be corrupted.

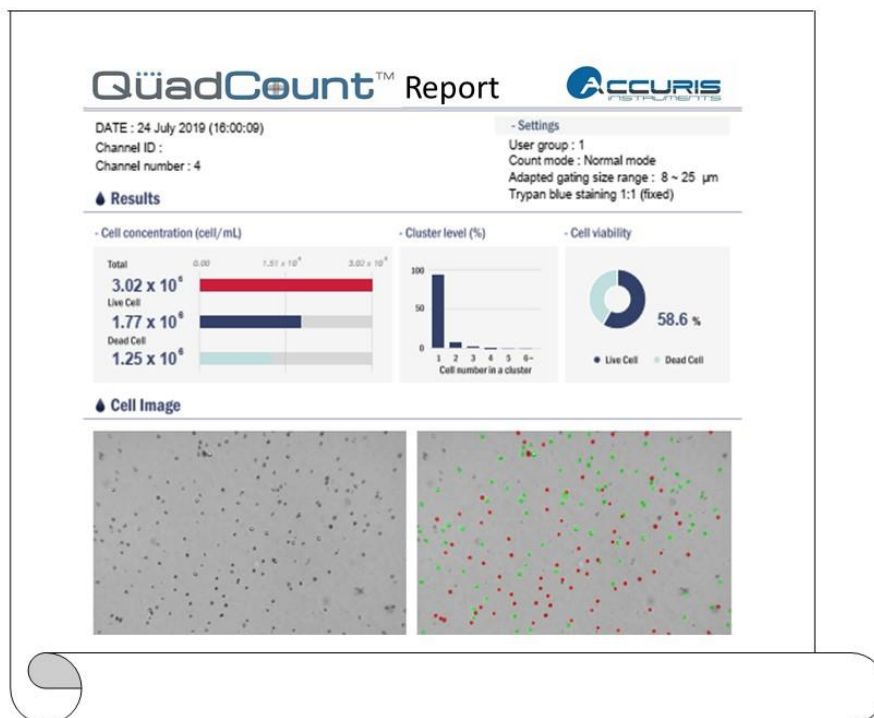

E. Exporting Data (all history) to a USB memory stick

The results, recorded in a current user group (All history), can be exported to a USB memory stick. Results data are saved automatically in the device memory of activated user group. By using the “Exporting Data” feature, the data are exported as CSV file (comma-separated-value format) which can be opened by Microsoft Excel.

- ! Please use the USB memory stick included with the QuadCount™ or another that is formatted to FAT32 or NTFS file system. USB memory sticks formatted to the ex-FAT file system is not supported.
If an ex-FAT File system memory stick is connected, the USB memory icon will display, but an error message "Unsupported USB memory" will appear when trying to export data or a report.

- ! The QuadCount™ automatically saves data up to 1000 records per each of groups.

Step 1. Select the User group.

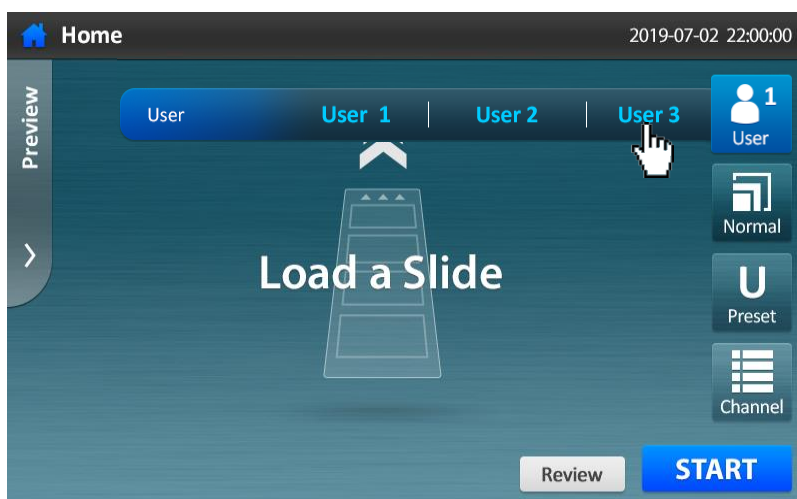

Step 2. Press Review.



Step 3. The auto-saved results are displayed for the selected user group.
 Connect a USB Memory stick to the USB port at the back side of the instrument.
 Confirm that the  icon is present on the status bar, indicating it is recognized.
 Press Export CSV button.

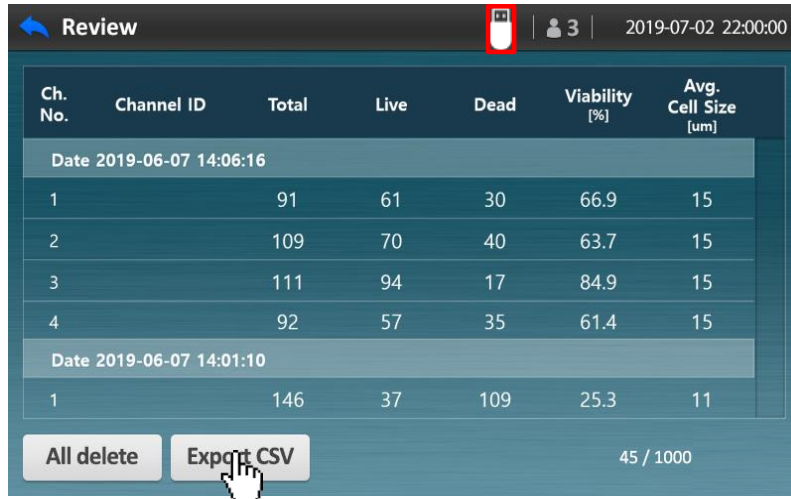

Step 4. A progress dialog box appears to indicate that exporting data is in progress.



Step 5. Once the progress dialog box disappears and the notification message “Exported all data” is displayed on status bar, remove the USB memory from USB port.

NOTE: If the USB memory stick is removed before the “data is exporting” message disappears, the results file may be corrupted.

Ch. No.	Channel ID	Total	Live	Dead	Viability [%]	Avg. Cell Size [um]
Date 2019-06-07 14:06:16						
1		91	61	30	66.9	15
2		109	70	40	63.7	15
3		111	94	17	84.9	15
4		92	57	35	61.4	15
Date 2019-06-07 14:01:10						
1		146	37	109	25.3	11

All delete Export CSV 45 / 1000

F. Showing channel ID names

Step 1. To see each of Channel ID names, press **Channel ID**.

To go back to the channel numbers, press **Back**.



The screenshot shows the 'Result' screen with a dark blue header. On the left, there is a vertical list of channel numbers 1, 2, 3, and 4. Below this list is a button labeled 'Channel ID' with an information icon. The main area displays a table with three columns: 'Total (x10⁴/mL)', 'Live (x10⁴/mL)', and 'Viability (%)'. The data rows are highlighted in blue. At the bottom, there are buttons for 'Review', 'Export PDF', 'Print', and 'Home'. A hand cursor is pointing at the 'Channel ID' button.

	Total (x10 ⁴ /mL)	Live (x10 ⁴ /mL)	Viability (%)
1	200	100	50
2	260	40	15
3	340	140	41
4	500	420	84

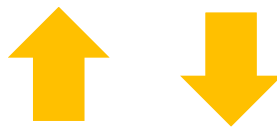

The screenshot shows the 'Result' screen after clicking 'Channel ID'. The left sidebar now displays the names for each channel: 1 JurkatT, 2 NIH, 3 Hela, and 4 U937. The main table data remains the same. At the bottom, there is a 'Back' button with a left-pointing arrow. A hand cursor is pointing at the 'Back' button.

Channel ID	Total (x10 ⁴ /mL)	Live (x10 ⁴ /mL)	Viability (%)
1 JurkatT	200	100	50
2 NIH	260	40	15
3 Hela	340	140	41
4 U937	500	420	84

Setting screen

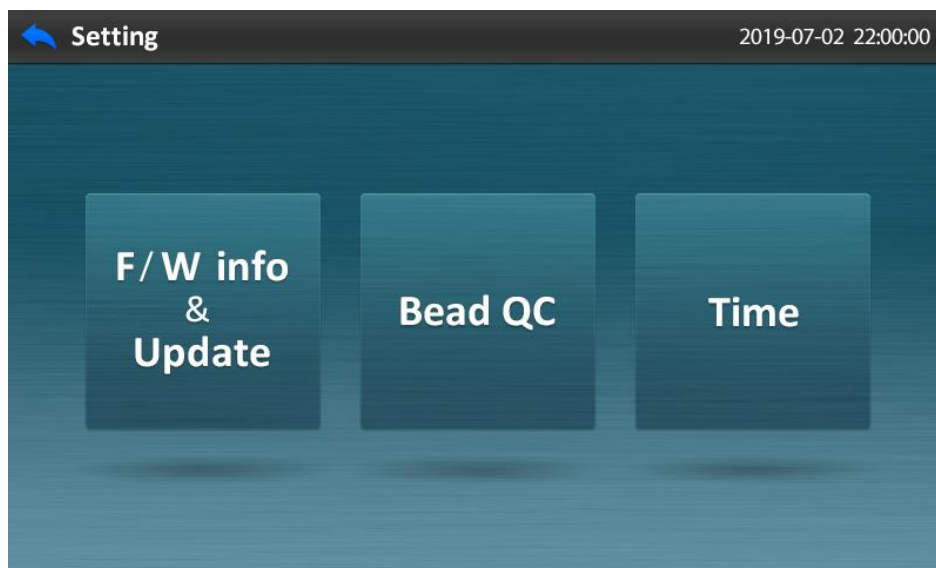
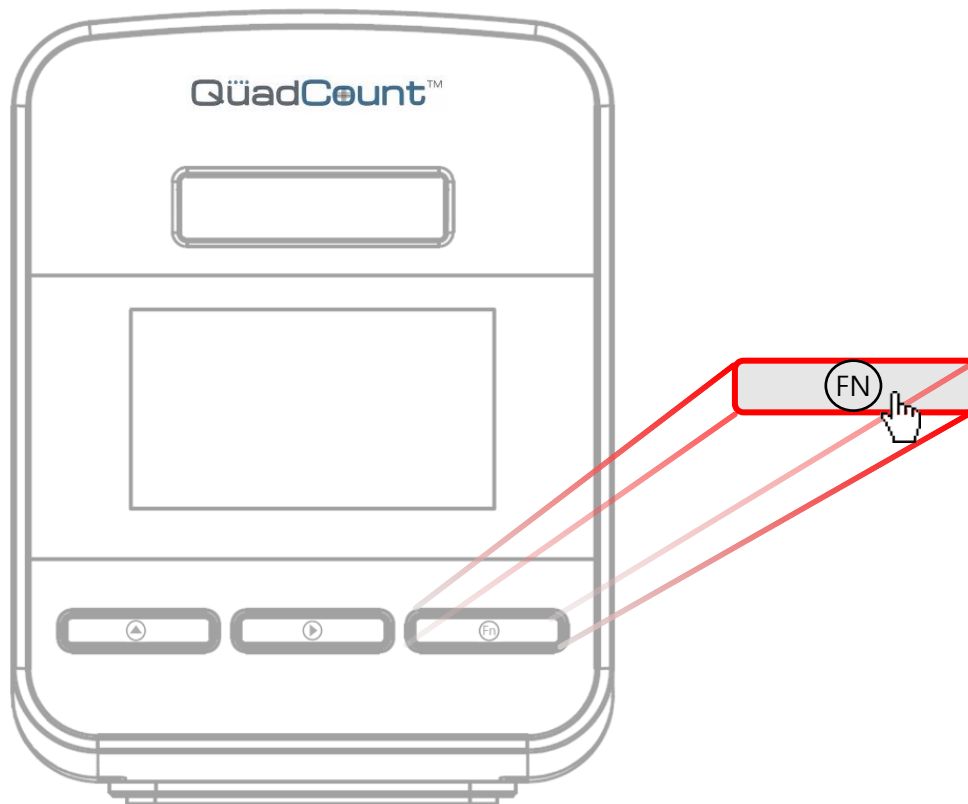

A. Checking Firmware information and Updating Firmware

Step 1. Press **F/W info & Update**, and connect a USB memory stick that contains the appropriate firmware update files.

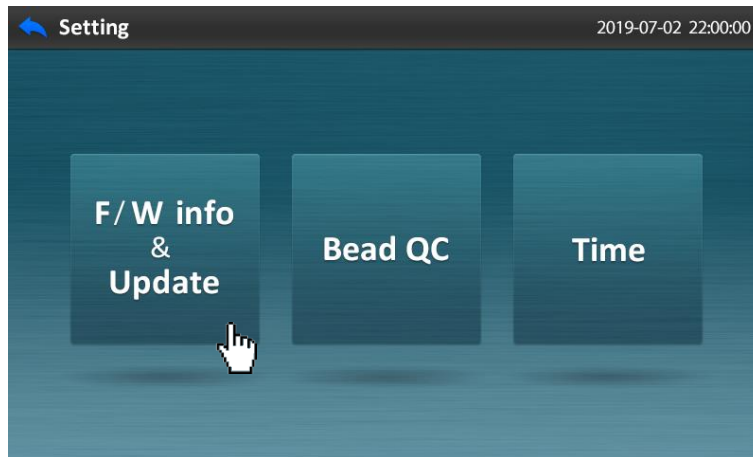

Step 2. Choose the firmware category to update (**Main** or **Display**).

If USB the memory stick is not connected or it does not contain the update program files, a message will be displayed.

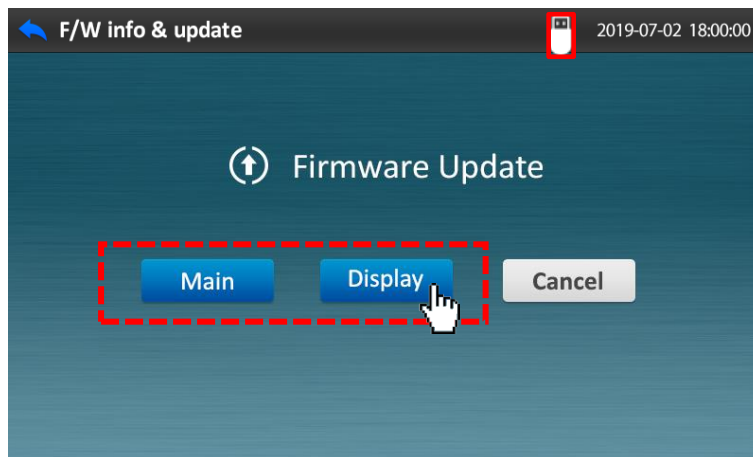

Step 3. Press **Update** button.



Step 4. Updating

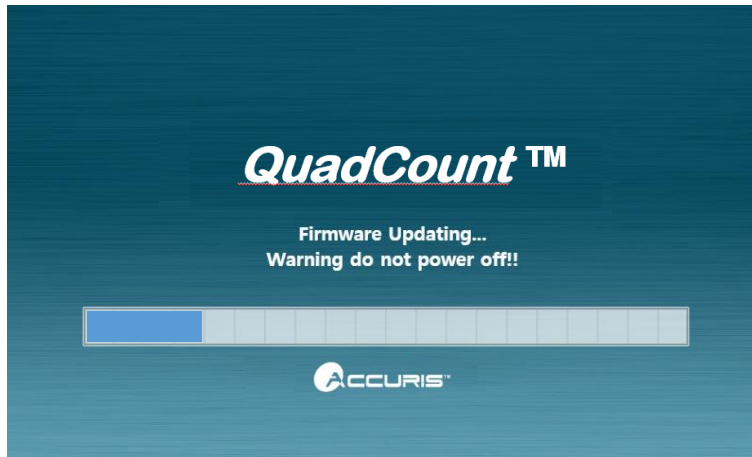

Step 5. The device will restart automatically with updated firmware version. Confirm that the version(s) have updated properly.

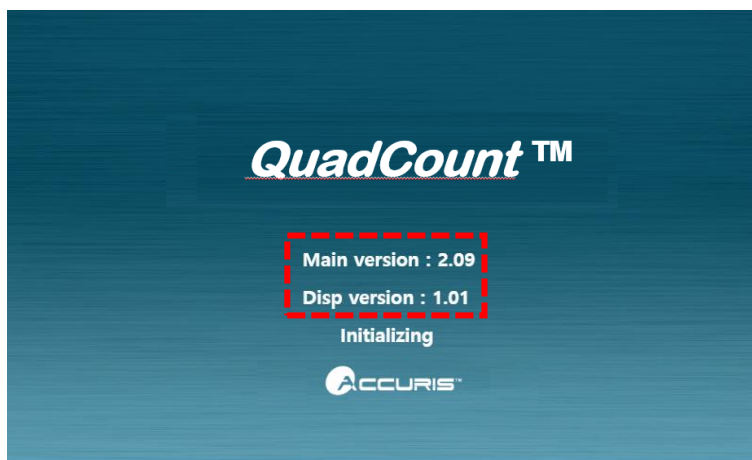

Step 6. After about 1 minute and the initialization is complete, switch the power to off and then back on again for stable operation.

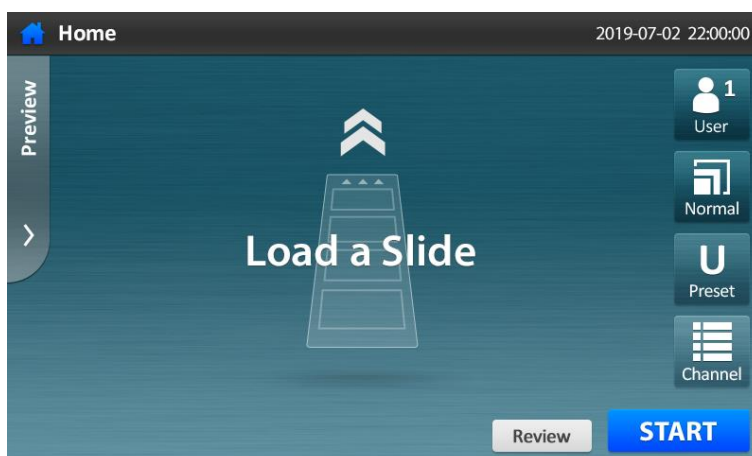

NOTE: When the following message "Please wait..." appears on the initialization screen after the firmware update, please wait 2~3 minutes. Do not turn the device off the device immediately.



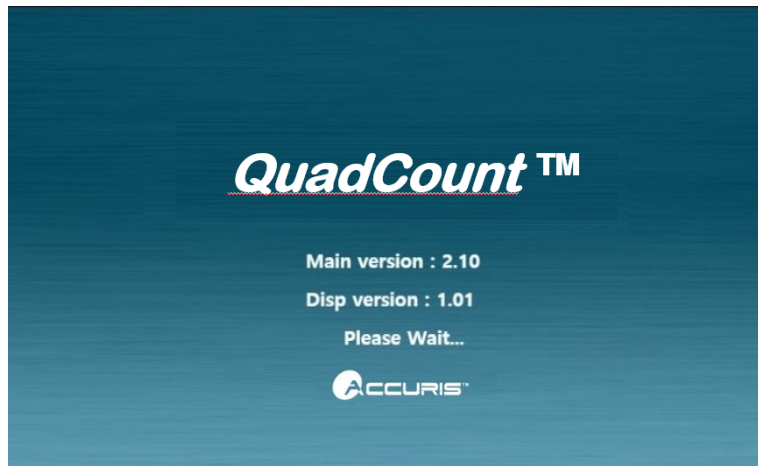

B. Bead Quality Control (Refer to the instructions included with the Bead QC kit for additional details.)

Step 1. Press the **Bead QC** button.

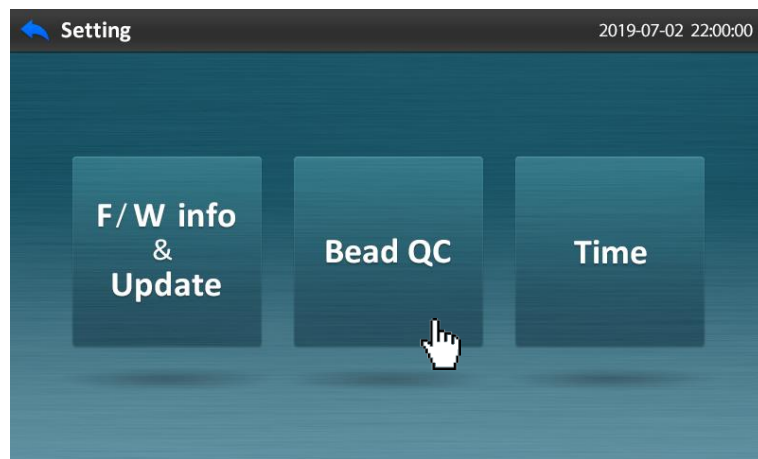

Step 2. Load a standard slide with the appropriate bead mixtures added to the sample chambers and press the **START** button.

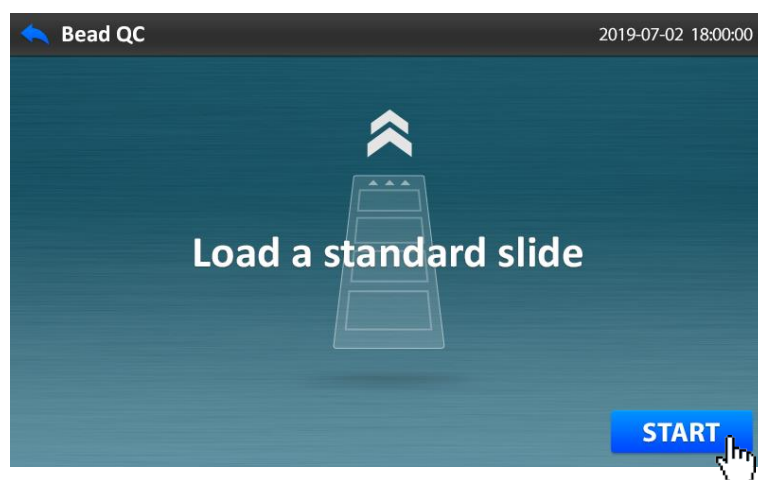

Step 3. Counting



Step 4. Check the resulting data.



Step 5. Check the Histogram and Bead image.



Step 6. Return to Home screen.



C. Setting the Date and Time

STEP 1. Press Time button.

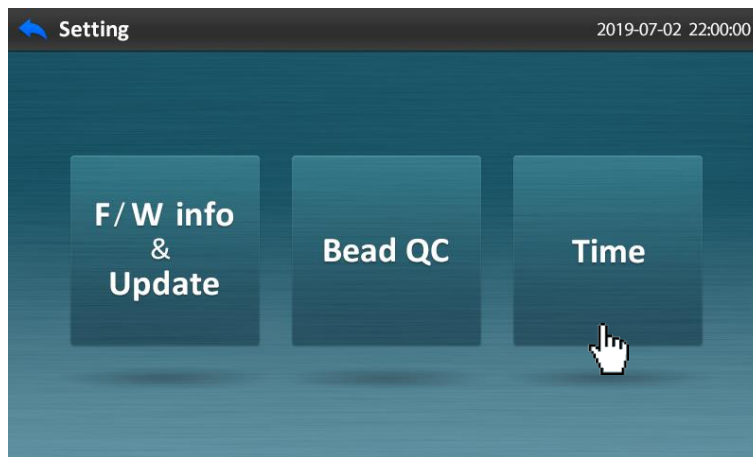

STEP 2. Adjust date and time accordingly.

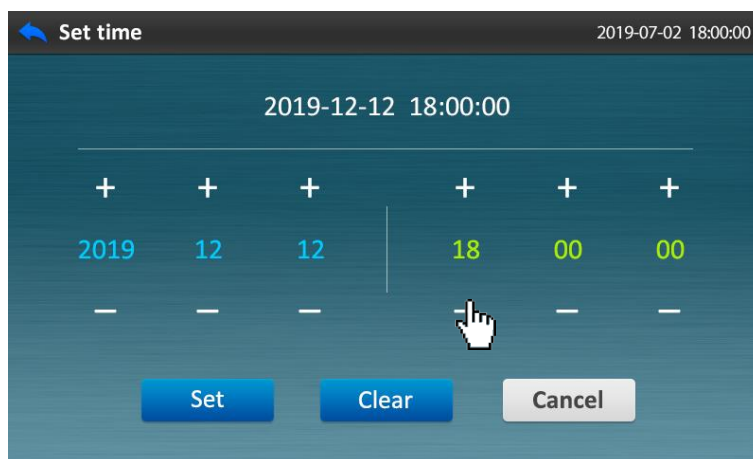

STEP 3. Press **Set** button to save the adjusted values.

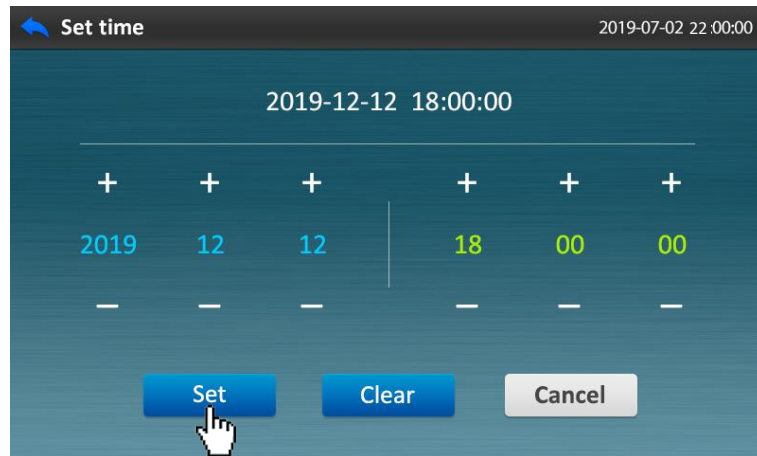

STEP 4. Return to the Home screen.

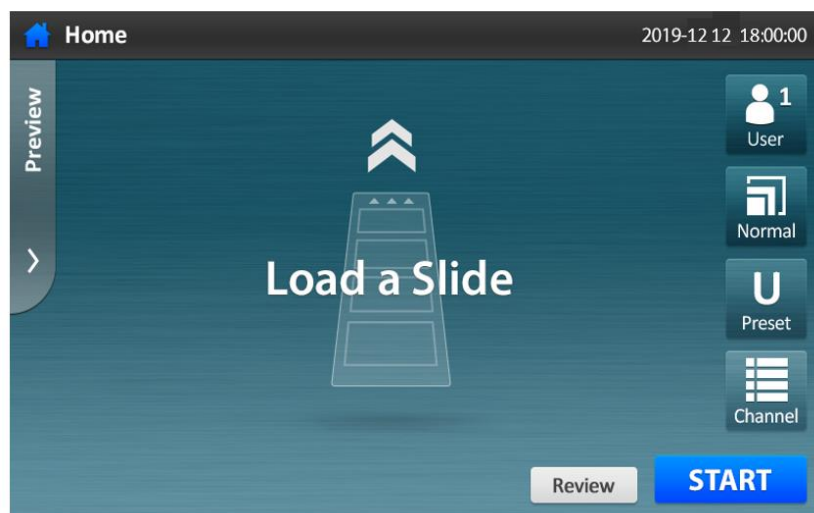

Maintenance and Cleaning

The QuadCount™ instrument does not require regular maintenance or regular replacement of parts or components. Clean the external surface of the device using a soft cloth. Isopropyl alcohol or deionized water can be used together for cleaning the housing.

Do not allow cleaning liquids or solutions to enter the housing.

Appendix A. Trouble Shooting

Problem	Cause	Solution
Device Not powering on	Power switch is in off position.	Check the power switch on back of unit.
	No power from outlet.	Check the power source.
	Bad power cable.	Replace the cable.
Inaccurate result	Stain solution has expired or been contaminated.	Use new stain solution or filter the solution.
	Too many aggregated cells.	Try again, pipette the cell mixture gently to mix the cells before adding to the slide chambers. (check the cell image for excessive cell clumping or agglomerates)
	Sampling error	<ul style="list-style-type: none"> ✓ Repeat steps of properly pipetting the cell mixture for the staining process. ✓ Before sampling the cell suspension, gently resuspend the cells at least 6 times by gently pipetting up and down ✓ Sample from the middle of the cell suspension tube, not near the surface or the bottom.
	Bubbles in slide chambers	Pay careful attention to avoid bubbles when pipetting and loading samples into the slide
	low cell concentration ($\leq 5 \times 10^4$)	Try again using the Precise mode.
	Cell size is smaller than $10\mu\text{m}$ or around $10\mu\text{m}$.	Change the gating size parameter in the histogram.
	The ratio of trypan blue in the sample is too high or too low..	Mix cell suspension and trypan blue at a 1:1 volume ratio.
Exported data or Report is corrupted	Too Bright or dark cell image	Mix cell suspension and trypan blue 1:1. If the problem is not resolved, contact Accuris or your local distributor.
	The grid pattern or line is visible in the result images.	Try again using another slide. If the problem occurs frequently, contact your local distributor.
	The USB memory was removed before displaying the notification message	Wait until after the notification message appears, then remove the USB memory.
USB memory Not Connected to device	The USB memory is formatted to ex-FAT or NTFS file system.	Use USB memory included with the QuadCount package or another formatted to FAT32 file system

- ❗ If trypan blue or media is contaminated or contains any debris which is similar in size and shape to cells, this will cause an inaccurate result.

Appendix B.

Examples of errors and inaccurate results

1. “Too Low” error

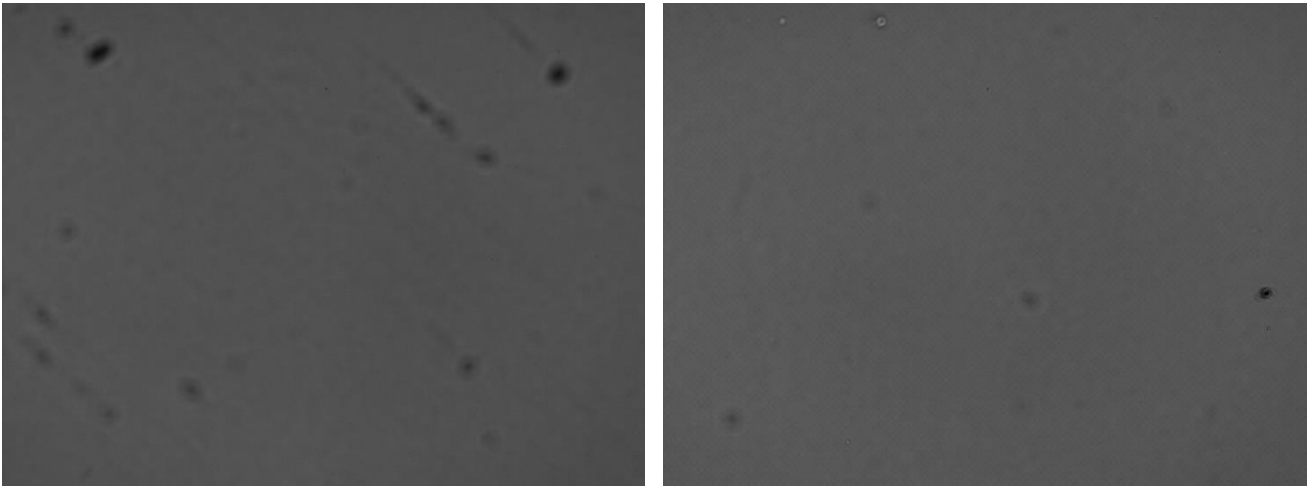

2. “Too High” error

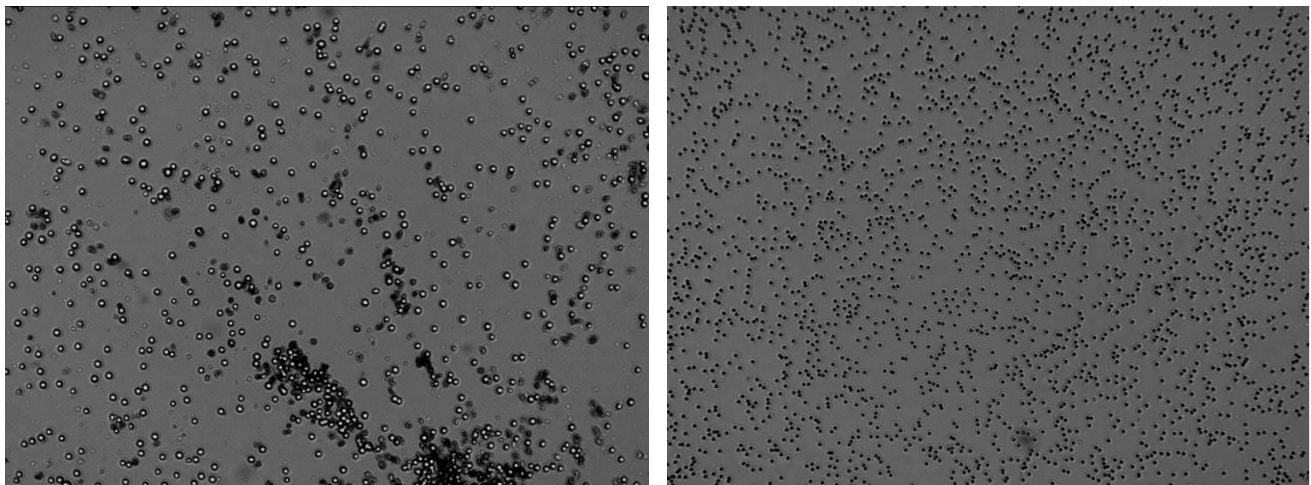

3. "Sample error"

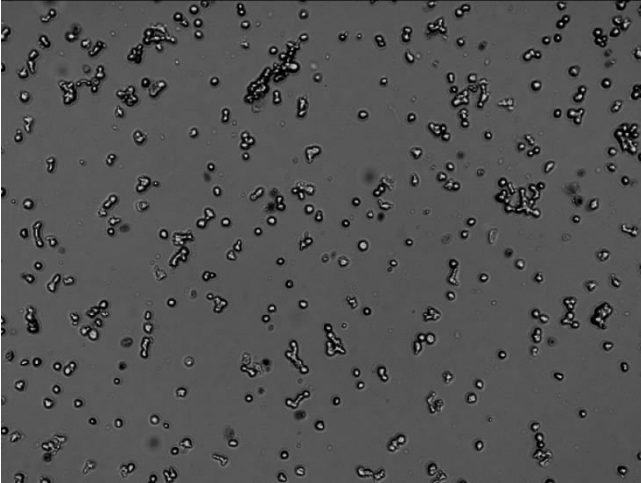

Cells are severely aggregated

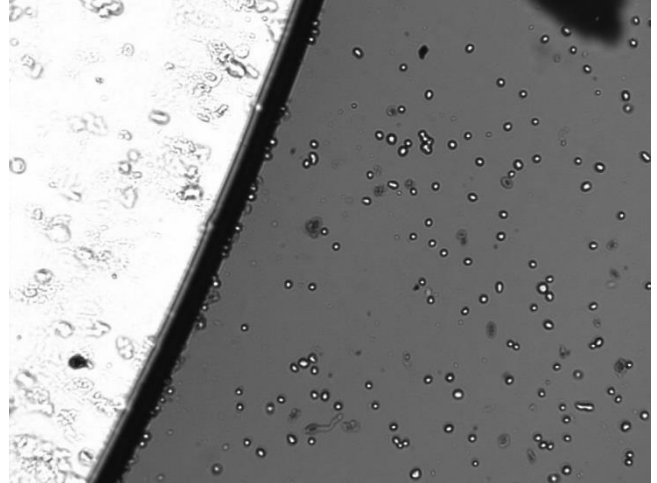

The sample loaded into the slide has dried out

4. Contaminated stain solution

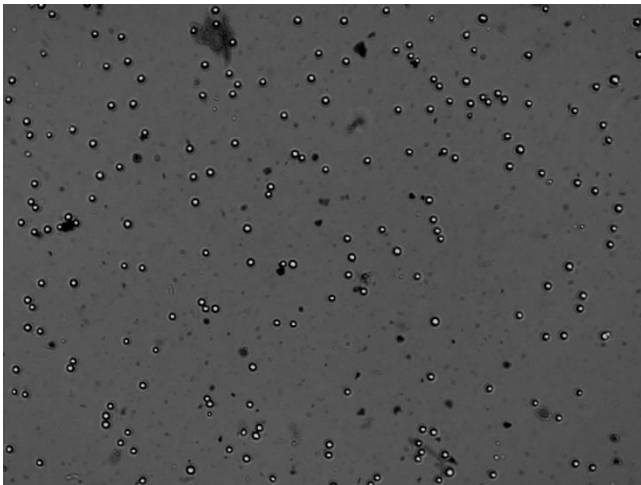

Cells mixed with contaminated trypan blue

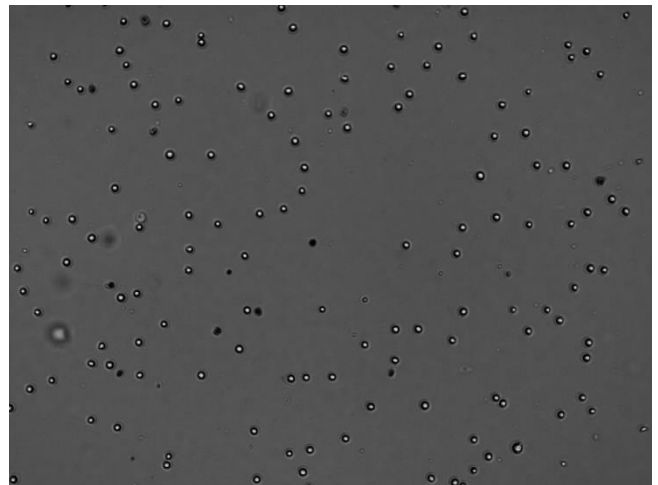

(Comparative image) Cells mixed with filtered trypan blue

Appendix C. The contents of Results Data exported as a .csv file:

History table (Excel data) consists of following items.

User	Selected user group
File created	Date and time when file was created
Channel No.	Channel number
Channel ID	Channel ID name
Date	Measurement date
Time	Measurement time
Total cell [x10⁴/mL]	Total cell Count result (x 1X10 ⁴ cells/mL) (Converted count result)
Live cell [x10⁴/mL]	Live cell Count result (x 1X10 ⁴ cells/mL) (Converted count result)
Dead cell [x10⁴/mL]	Dead cell Count result (x 1X10 ⁴ cells/mL) (Converted count result)
Viability	Cell viability (%)

Appendix D.

Example and explanation of PDF report

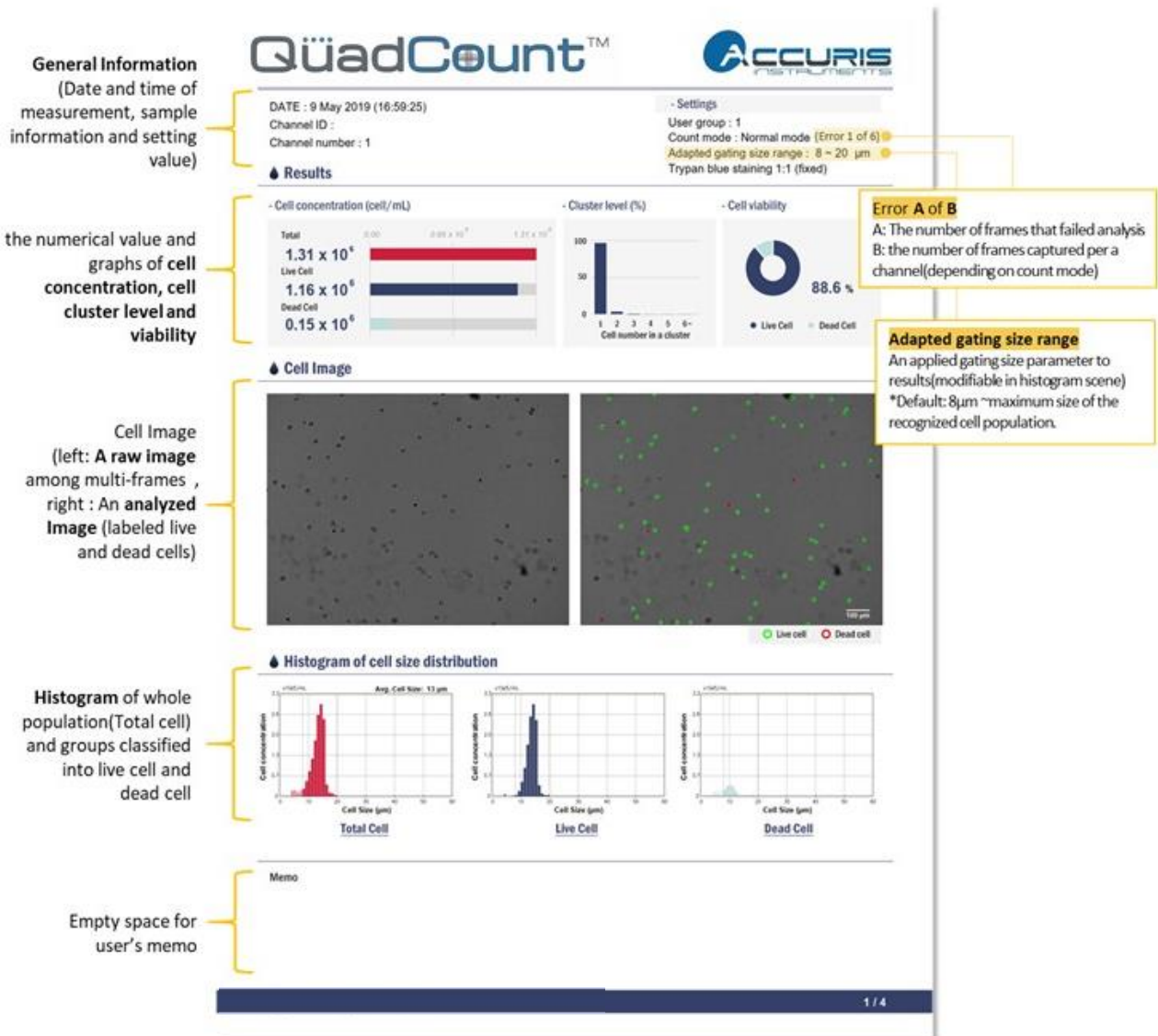

All the materials in this manual are protected by US and international copyright laws and cannot be reproduced, translated, published or distributed without the permission of the copyright owner.

QuadCount™ Instruction Manual

Website: <http://www accuris-usa.com>

E-mail: info@accuris-usa.com

Accuris Instruments (a division of Benchmark Scientific)

PO Box 709

Edison, NJ 08818.

PH: 908.769.5555

FAX: 732.313.7007

The information in this manual is described as correctly as possible and is applicable to the latest firmware versions, but it may be changed without prior consent or notification.

Copyright ©2020, Accuris Instruments.

All rights reserved