

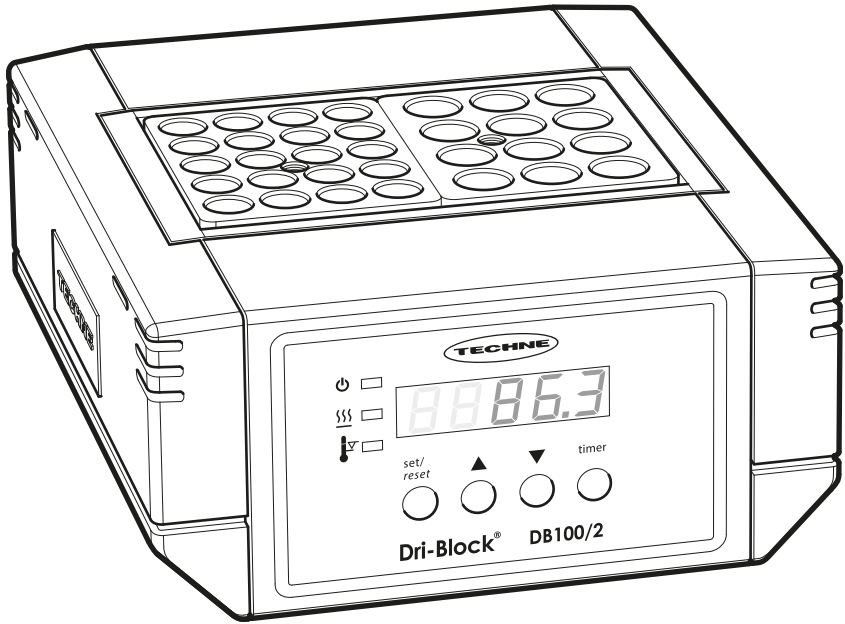

Dri-Block[®] Heater
DB100/2, DB100/3,
DB100/4, DB100/2TC,
DB200/2 and DB200/3



Instruction Manual
6106451 / Version 10

DB100/2, DB100/3, DB100/4, DB100/2TC, DB200/2, DB200/3

CONTENTS	PAGE
INTRODUCTION	5
BEFORE USE	6
SAFETY and INSTALLATION	7
English	7
Français	9
Deutsch	11
Español	13
Italia	15
CONTACT INFORMATION	17
SPECIFICATIONS	18
OPERATION	21
Installation	21
Power up screen	22
The front panel controls	22
Setting the temperature units	23
Setting the operating temperature	23
Setting the timer	23
After use	24
User maintenance	24
Calibration	25
ADDITIONAL INFORMATION	26
Fault finding	26
Fuses	26
Safety over-temperature cut-out	26
Support contacts	27
ACCESSORIES	28
REPLACEMENT PARTS	29
DECLARATION OF CONFORMITY	30

INTRODUCTION

Please read all the information in this booklet before using the unit.

Techne Dri-Block[®] heaters provide a safe, dry, constant temperature source in the laboratory. The units can be used for incubation, boiling, inactivation, wet ashing, sample concentration, enzyme analysis and many other clinical and industrial purposes.

The units cover the temperature range from ambient +5°C to 100°C or 200°C (depending on model) using machined aluminium alloy blocks as the heat transfer medium. Independent indicator lights indicate mains power, heater action and over-temperature cut-out. An ON/OFF switch is mounted on the rear panel, together with the mains connector and a double fuse holder.

Temperature setting is via a simple push button display. Temperatures can be displayed in °C or °F. Each unit also has a built-in count-down timer which can be set in 1 minute intervals to 99h 59m.

The units are constructed of painted aluminium alloy and polyphenylene sulphide (PPS) plastic, which is strong yet lightweight and can resist sustained temperatures as high as 260°C. Even though the units heat up rapidly, venting and highly efficient insulation ensure that the cases remain cool enough to handle even at maximum operating temperatures.

Each unit is supplied with an extraction tool for easy removal of the insert blocks.

The operating instructions in this Operator's Manual cover the following range of digital Dri-Block[®] heaters:

Model number	Description	Voltage, frequency
DB100/2	Dri-Block [®] heater ambient to 100°C, accepts 2 insert blocks	230V, 50-60Hz
DB100/2/115	Dri-Block [®] heater ambient to 100°C, accepts 2 insert blocks	115V, 50-60Hz
DB100/3	Dri-Block [®] heater ambient to 100°C, accepts 3 insert blocks	230V, 50-60Hz
DB100/3/115	Dri-Block [®] heater ambient to 100°C, accepts 3 insert blocks	115V, 50-60Hz
DB100/4	Dri-Block [®] heater ambient to 100°C, accepts 4 insert blocks	230V, 50-60Hz
DB100/4/115	Dri-Block [®] heater ambient to 100°C, accepts 4 insert blocks	115V, 50-60Hz
DB100/2TC	Dri-Block [®] heater ambient to 100°C, accepts 2 insert blocks, twin control	230V, 50-60Hz
DB100/2TC/115	Dri-Block [®] heater ambient to 100°C, accepts 2 insert blocks, twin control	115V, 50-60Hz
DB200/2	Dri-Block [®] heater ambient to 200°C, accepts 2 insert blocks	230V, 50-60Hz
DB200/2/115	Dri-Block [®] heater ambient to 200°C, accepts 2 insert blocks	230V, 50-60Hz
DB200/3	Dri-Block [®] heater ambient to 200°C, accepts 3 insert blocks	230V, 50-60Hz
DB200/3/115	Dri-Block [®] heater ambient to 200°C, accepts 3 insert blocks	115V, 50-60Hz

The features of individual models are outlined in the Specifications section of this manual.

Note: This manual covers the digital Dri-Block[®] heater range. The analogue Dri-Block[®] heaters DB-2A, DB-3 and DB-3A are covered in a separate user manual.

BEFORE USE

Before using the Dri-Block[®] heater please make sure you have read this manual carefully. If there is any doubt relating to the proper use of this equipment, the staff at Cole-Parmer Ltd. or your supplier will be happy to assist you.

UNPACKING

When unpacking the unit please ensure that the following have been removed from the packaging:

Dri-Block[®] heater

6101308 Extraction tool

Mains cables (UK and EU or US)

Operator's manual

Guarantee card

The user is advised to keep the original packaging in case the instrument ever needs to be returned for service or repair. Cole-Parmer Ltd. accepts no responsibility for damage incurred unless the unit is correctly packed and transported in its original packaging.

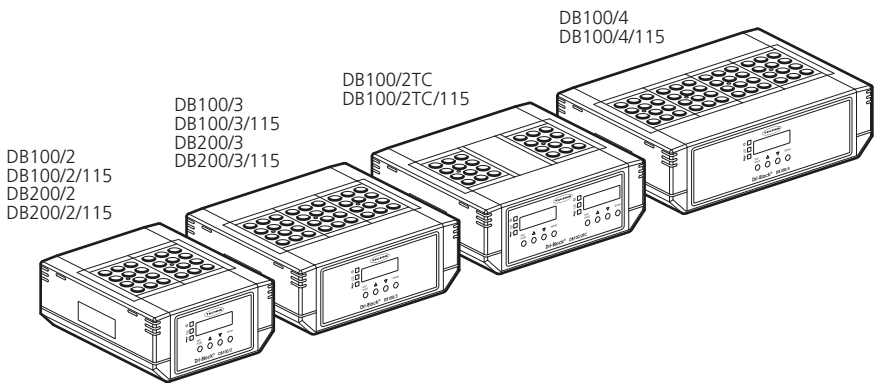

The Dri-Block[®] heater range

SAFETY AND INSTALLATION

Please read all the information in this manual before using the Dri-Block® heater.

WARNING

HIGH TEMPERATURES ARE DANGEROUS: they can cause serious burns to operators and ignite combustible material.

Techne have taken great care in the design of these units to protect operators from hazards, but operators should pay attention to the following points:



- USE CARE AND WEAR PROTECTIVE GLOVES TO PROTECT HANDS.
- DO NOT use combustible substances near hot objects.
- DO NOT operate the instrument in the vicinity of inflammable liquids or gases.
- DO NOT place any liquid directly into the instrument.

OPERATOR SAFETY

All operators of Techne equipment must have available the relevant literature needed to ensure their safety. It is important that only suitably trained personnel operate this equipment, in accordance with the instructions contained in this manual and with general safety standards and procedures. If the equipment is used in a manner not specified by Cole-Parmer Ltd. the protection provided by the equipment to the operator may be impaired.

All Techne instruments are designed to conform to international safety requirements and are fitted with an over-temperature cut-out.

If a safety problem should be encountered, switch off the unit at the mains socket and remove the plug from the electricity supply.

INSTALLATION

The instrument should be carried using both hands. Never move or carry the instrument when in use or connected to the mains electricity supply.

1. All Techne instruments are supplied with a power cable; this may be integral or plug-in.

2.  Before connecting the instrument to the mains electricity supply, check the voltage against the rating plate (located on the back of the unit). **Please note that the unit must be earthed to ensure proper electrical safety.** Connect the mains cable to a suitable plug according to the table below.

<i>Connections</i>	<i>230V, 50/60Hz</i>	<i>115V, 50/60Hz</i>
Live	Brown	Black
Neutral	Blue	White
Earth	Green/yellow	Green

Note that units marked 230V on the rating plate work at 207V; units marked 115V work at 104V. In both cases, however, the heating rate will degrade by approximately 8%.

3. Place the unit on a suitable flat bench or in a fume cupboard if required, ensuring that the air inlet vents on the underside are free from obstruction.
4. Plug the mains cable into the socket on the back of the instrument.
5. Switch on the instrument. Symbols on or near the power switch of the unit have the following meanings:
 - I Mains Switch On
 - O Mains Switch Off

Replacement cable

Should the mains lead need replacement, a cable of 1mm² of harmonized code H05VV-F connected to an IEC320 plug should be used. **IF IN DOUBT CONSULT A QUALIFIED ELECTRICIAN.**

ENVIRONMENTAL CONDITIONS

The Dri-Block[®] heater is designed operate under the following conditions:

- Indoor use
- Ambient temperature range +5°C to +40°C
- Altitude to 2000m
- Relative humidity up to 80%
- Mains supply fluctuations not exceeding 10%
- Over voltage category II IEC 60364-4-443
- Pollution degree 2
- Use with a minimum distance all-around of 200mm from walls or other items

Note: The control specifications are quoted at an ambient temperature of 20°C. The specification may deteriorate outside an ambient temperature of between 10°C and 30°C.

The instrument has been tested for radio frequency interference and is certified under EN61326.

GUARANTEE

The instrument is guaranteed against any defect in material or workmanship for the period specified on the enclosed guarantee card. This period is effective from the date of purchase; within this period all defective parts will be replaced free of charge provided that the defect is not the result of an accident, misuse or negligence. Servicing under this guarantee should be obtained from the supplier of the instrument.

This manual has been prepared for the convenience of Techne's customers and nothing in this manual shall be taken as a warranty, condition or representation concerning the description, merchantability, fitness for purpose or otherwise of the unit or components.

Notwithstanding the description and specification(s) of the instruments contained in the operator's manual, Techne reserves the right to make such changes as it sees fit to the instruments or to any of the components.

SÉCURITÉ ET CONSIGNES D'INSTALLATION

Veillez lire attentivement toutes les instructions de ce document avant d'utiliser le Dri-Block® heater.

AVERTISSEMENT

Les TEMPÉRATURES ÉLEVÉES SONT DANGEREUSES car elles peuvent provoquer de graves brûlures chez l'opérateur et enflammer les matériaux combustibles.

Techne a apporté un soin tout particulier à la conception de ces appareils de façon à assurer une protection maximale des opérateurs, mais il est recommandé aux utilisateurs de porter une attention spéciale aux points suivants :



- PROCÉDER AVEC PRUDENCE ET PORTER DES GANTS POUR SE PROTÉGER LES MAINS
- NE PAS utiliser de matériaux combustibles auprès d'objets chauds.
- NE PAS utiliser l'appareil à proximité de liquides ou de gaz inflammables
- NE PAS verser de liquides directement dans l'appareil.

SÉCURITÉ DE L'OPÉRATEUR

Tous les utilisateurs de produits Techne doivent avoir pris connaissance des consignes et instructions nécessaires à la garantie de leur sécurité. Important: cet appareil doit impérativement être manipulé par un personnel qualifié et être utilisé selon les instructions données dans ce document, en accord avec les normes et procédures de sécurité générales. Dans le cas où cet appareil ne serait pas utilisé selon les consignes précisées par Cole-Parmer Ltd., la protection pour l'utilisateur ne serait alors plus garantie.

Tous les appareils Techne sont conçus pour répondre aux normes de sécurité internationales et sont dotés d'un coupe-circuit en cas de surchauffe.

En cas de problème de sécurité, couper l'alimentation électrique au niveau de la prise murale et enlevez la prise connectée à l'appareil.

INSTALLATION

Porter l'appareil à deux mains. Ne jamais déplacer ou transporter l'appareil lorsqu'il est en fonctionnement ou branché à l'alimentation électrique.

1. Tous les appareils Techne sont livrés avec un câble d'alimentation qui peut être intégré à l'appareil ou à raccorder.
2.  Avant de raccorder l'appareil à l'alimentation électrique sur secteur, vérifier la tension requise indiquée sur la plaque d'identification (située au dos de l'appareil). **Il est important que l'appareil soit relié à la terre pour assurer la protection électrique requise.** Brancher le câble secteur sur une prise appropriée, voir tableau ci-après.

Connexions	230V, 50/60 Hz	115V, 50/60 Hz
Phase	Marron	Noir
Neutre	Bleu	Blanc
Terre	Vert/jaune	Vert

Remarque : les appareils dont la plaque indique 230 V peuvent fonctionner sur 207 V, et ceux dont la plaque indique 115 V peuvent fonctionner sur 104 V. Dans les deux cas cependant, la capacité de chauffage diminuera d'environ 8 %.

3. Placer l'appareil sur une surface plane ou si nécessaire sous une hotte d'aspiration, veiller à ce que les trous d'aération situés sous l'appareil ne soient pas obstrués.
4. Raccorder le câble d'alimentation à la prise située à l'arrière de l'appareil.
5. Allumer l'appareil. Les symboles situés sur ou à côté de l'interrupteur de l'appareil ont la signification suivante :

- | | |
|----------|---|
| I | Interrupteur secteur en position Marche |
| O | Interrupteur secteur en position Arrêt |

Câble de rechange

S'il s'avère nécessaire de remplacer le cordon d'alimentation, utiliser un câble de 1 mm² conforme à la norme H05VV-F relié à une prise IEC320. **EN CAS DE DOUTE, CONSULTER UN ELECTRICIEN QUALIFIE.**

CONDITIONS ENVIRONNEMENTALES

Le Dri-Block[®] heater est conçu pour fonctionner dans les conditions suivantes:

- Pour un usage intérieur seulement
- Température ambiante +5°C à +40°C
- Altitude inférieure à 2000m
- Humidité relative ne dépassant pas 80%
- Fluctuations de l'alimentation n'excédant pas 10% de la valeur nominale
- Catégorie II IEC 60364-4-443 de surtension
- Degré de pollution 2
- Utiliser à une distance minimale sur le pourtour de 200mm par rapport aux murs et autres équipements

Remarque: Les paramètres sont indiqués pour une température ambiante de 20°C. Ces caractéristiques peuvent se détériorer en dehors d'une température ambiante de 10 à 30°C.

L'appareil a été testé en matière de radiofréquences et est certifié selon la norme EN61326.

GARANTIE

appareil est garanti contre tout défaut de matériaux ou vice de fabrication pendant la période précisée sur la carte de garantie jointe. Cette période s'applique à compter de la date d'achat. Au cours de cette période, toutes les pièces défectueuses seront remplacées gratuitement dans la mesure où la défaillance n'est pas due à un accident, une mauvaise utilisation ou une négligence. Toute réparation sous garantie sera effectuée par le fournisseur.

Le présent manuel a été exclusivement rédigé à l'attention des clients de la marque Techne et rien dans son contenu ne doit être pris comme une garantie, une condition ou une affirmation concernant la description, la commercialisation, l'adéquation à un usage particulier de l'appareil ou de ses composants.

Malgré la description et les caractéristiques techniques des appareils données dans le manuel de l'utilisateur, la société Techne se réserve le droit d'apporter les changements nécessaires à l'appareil ou à tout élément qui entre dans sa composition.

SICHERHEITS- UND INSTALLATIONSINFORMATIONEN

Lesen Sie diese Anleitung vor Verwendung des Dri-Block® heater bitte sorgfältig durch.

ACHTUNG

HOHE TEMPERATUREN STELLEN EINE GEFAHRENQUELLE DAR. Sie können schwere Brandverletzung verursachen und brennbare Stoffe entzünden.

Techne hat bei der Konstruktion dieses Gerätes sehr darauf geachtet, daß der Bediener vor Gefahren geschützt ist. Dennoch sollten Sie auf die folgenden Punkte achten:



- UMSICHTIG VORGEHEN UND SCHUTZHANDSCHUHE TRAGEN
- KEINE brennbaren Stoffe in der Nähe heißer Gegenstände verwenden
- Das Gerät NICHT in der Nähe entzündlicher Flüssigkeiten oder Gase betreiben
- Flüssigkeiten NICHT direkt auf das Gerät auftragen.

SICHERHEIT DES BEDIENPERSONALS

Alle Benutzer von Techne Geräten müssen Zugang zu der entsprechenden Literatur haben, um ihre Sicherheit zu gewähren. Es ist wichtig, daß diese Geräte nur von entsprechend geschultem Personal betrieben werden, das die in dieser Gebrauchsanweisung enthaltenen Maßnahmen und allgemeine Sicherheitsbestimmungen und -vorkehrungen beachtet. Wenn das Gerät anders eingesetzt wird als vom Hersteller empfohlen, kann dies die persönliche Sicherheit des Anwenders beeinträchtigen.

Die Geräte von Techne entsprechen den internationalen Sicherheitsbestimmungen und sind mit einem automatischen Übertemperaturabschalter ausgestattet.

Wenn ein Sicherheitsproblem auftreten sollte, muß das Gerät ausgeschaltet und vom Stromnetz getrennt werden.

INBETRIEBNAHME

Das Gerät mit beiden Händen tragen. Das Gerät unter keinen Umständen transportieren, wenn es in Betrieb ist, oder während das Gerät noch am Netz angeschlossen ist.

1. Alle Geräte von Techne werden mit einem Netzkabel geliefert, das entweder eingesteckt wird oder fest mit dem Gerät verbunden ist.

2.  Vor dem Anschluss bitte kontrollieren, ob die Stromversorgung den Angaben auf dem Typenschild (auf der Geräterückseite) entspricht. **Um die elektrische Sicherheit zu gewährleisten, muss dieses Gerät geerdet werden.** Schließen Sie das Netzkabel entsprechend der folgenden Tabelle an einen geeigneten Stecker an.

Anschluss	230V, 50/60Hz	115V, 50/60Hz
Phase	Braun	Schwarz
Neutral	Blau	Weiß
Erde	Grün/Gelb	Grün

Geräte, die für 230 Volt ausgelegt sind, können auch bei 207 Volt arbeiten, Geräte für 115 Volt auch bei 104 Volt. In beiden Fällen verringert sich die Aufheizrate um ca. 8%.

3. Stellen Sie das Gerät auf einen geeigneten ebenen Tisch oder in einem Abzugsschrank auf und sorgen Sie dafür, dass die Lufteinlassschlitze auf der Geräteunterseite nicht blockiert sind.
4. Stecken Sie das Netzkabel in die Buchse auf der Geräterückseite ein.
5. Schalten Sie das Gerät ein:

- | | |
|---|------------------|
| I | Netzschalter Ein |
| O | Netzschalter Aus |

Ersatzkabel

Bei einem eventuellen Austausch des Netzkabels wird ein Kabel vom Typ H05VV-F mit 1 mm² Aderquerschnitt und Europastecker (IEC 320) benötigt.

IM ZWEIFELSFALL EINEN ELEKTRO-FACHMANN HINZUZIEHEN.

UMWELTBEDINGUNGEN

Der Dri-Block[®] heater ist für den Einsatz unter folgenden Bedingungen ausgelegt:

- Gebrauch in Innenräumen
- Umgebungstemperatur zwischen +5°C to +40°C
- Höhe: bis zu 2000 m
- Relative Feuchte nicht über 80%
- Netzspannungsschwankungen nicht über 10%
- Überspannungsklasse 2 IEC 60364-4-443
- Verschmutzungsgrad 2
- Der Mindestabstand zwischen dem Gerät und umgebenden Wänden oder Gegenständen muss 200mm betragen

Hinweis: Die Gerätespezifikationen beziehen sich auf eine Umgebungstemperatur von 20°C und können sich außerhalb des Bereichs 10°C bis 30°C verschlechtern.

Das Gerät wurde auf HF-Störeinflüsse geprüft und entspricht den EMV-Bedingungen nach EN61326.

GARANTIE

Techne gewährleistet, dass dieses Gerät für den auf der Garantiekarte angegebenen Zeitraum keine Herstellungs- und Materialmängel aufweist. Dieser Zeitraum tritt ab dem Verkaufsdatum in Kraft. Innerhalb dieses Zeitraums werden alle defekten Teile kostenlos ausgetauscht, soweit der Defekt nicht auf einen Unfall, Missbrauch oder Nachlässigkeit zurückzuführen ist. Wartungsarbeiten, die unter diese Garantie fallen, müssen von der Verkaufsstelle für dieses Gerät gehandhabt werden.

Diese Anleitung wurde zur Information der Kunden von Techne erstellt und stellt in keinsten Weise eine Gewährleistung, Bedingung oder Darstellung bezüglich der Beschreibung, Marktgängigkeit oder Zweckdienlichkeit dieser Geräte oder Bauteile dar.

Unabhängig von Beschreibung und Spezifikation(en) des hier beschriebenen Geräts behält sich Techne das Recht vor, Änderungen an diesem Gerät oder dessen Bauteilen vorzunehmen.

INFORMAZIONI SULLA SICUREZZA E L'INSTALLAZIONE

Leggere attentamente il presente manuale prima di usare il Dri-Block® heater.

AVVERTENZA

Le ALTE TEMPERATURE SONO PERICOLOSE in quanto possono provocare serie ustioni agli operatori e dare fuoco al materiale combustibile.

La Techne ha posto particolare cura nel progettare questo strumento, al fine di proteggere gli operatori da eventuali pericoli, ma gli utilizzatori devono prestare attenzione ai seguenti punti:



- PRESTARE ATTENZIONE ED INDOSSARE GUANTI PROTETTIVI PER LE MANI
- NON usare sostanze combustibili vicino ad oggetti caldi
- NON mettere in funzione lo strumento nei pressi di liquidi o gas infiammabili
- NON collocare alcun tipo di liquido direttamente nello strumento.

SICUREZZA DELL'OPERATORE

Il personale che utilizza l'apparecchiatura Techne deve avere a disposizione la documentazione necessaria al fine di assicurare la loro incolumità. È importante che solo personale adeguatamente addestrato utilizzi questo apparecchio, in conformità alle istruzioni contenute in questo manuale e nel rispetto delle normative e procedure generali di sicurezza. Se l'apparecchio è utilizzato in modo non specificato da Cole-Parmer Ltd., la protezione fornita dall'apparecchiatura all'utilizzatore potrebbe essere a rischio.

Tutte le unità Techne sono state progettate in conformità ai requisiti internazionali di sicurezza e sono equipaggiate con un interruttore anti surriscaldamento.

Se si dovesse verificare qualche problema di sicurezza, disconnettere l'apparecchio dalla rete.

INSTALLAZIONE

Occorre trasportare lo strumento usando entrambe le mani. Non spostare né trasportare lo strumento quando è in funzione o collegato all'alimentazione elettrica di rete.

1. Tutti gli strumenti Techne sono forniti con un cavo di alimentazione; può essere integrale o plugin.

2.  Prima di collegare lo strumento all'alimentazione elettrica di rete, controllare la tensione confrontandola con la targhetta riportante i valori nominali (si trova sul retro dell'unità).

Notare che al fine di garantire la corretta sicurezza elettrica, occorre che l'unità sia messa a terra. Collegare il cavo di rete ad una presa idonea secondo la tabella riportata alla pagina successiva.

Connessione	230V, 50/60Hz	115V, 50/60Hz
Sotto tensione	Marrone	Nero
Neutro	Blu	Bianco
Terra	Verde/giallo	Verde

Tenere presente che gli apparecchi riportanti sulla targhetta 230 V funzionano a 207V. Gli apparecchi riportanti 115V funzionano a 104V. Comunque, in entrambi i casi la velocità di riscaldamento diminuirà approssimativamente dell'8%.

3. Collocare l'unità su un banco piano idoneo o in una cappa aspirante se necessario, assicurandosi che gli sfiati delle prese d'aria nella parte inferiore non siano ostruiti.
4. Inserire il cavo di rete nella presa che si trova sul retro dello strumento.
5. Accendere lo strumento:

I	Interruttore di rete Acceso
O	Interruttore di rete Spento

Cavo di ricambio

Qualora occorra sostituire il cavo di rete, si dovrà utilizzare un cavo di 1 mm² codice armonizzato H05VV-F collegato ad una spina IEC 320. **IN CASO DI DUBBIO, RIVOLGERSI A UN ELETTRICISTA QUALIFICATO.**

CONDIZIONI AMBIENTALI

Il Dri-Block® heater è stato progettato per funzionare nelle seguenti condizioni:

- uso interno
- range di temperatura ambiente da +5°C a +40°C
- altitudine massima 2000 m.
- umidità relativa non superiore all'80%
- oscillazione dell'alimentazione di rete non superiore al 10%
- categoria di sovratensione II IEC 60364-4-443
- grado di inquinamento 2
- Con distanza minima tra i lati dell'apparecchio e il muro o altri oggetti di almeno 200mm

Nota: le specifiche di controllo sono indicate ad una temperatura ambiente di 20°C. Le specifiche potrebbero peggiorare fuori da una temperatura ambiente compresa tra 10°C e 30°C.

Lo strumento è stato collaudato per interferenze da radiofrequenze ed è certificato secondo la norma EN61326.

GARANZIA

Lo strumento è garantito da qualsiasi difetto nei materiali o nella lavorazione per il periodo specificato nella scheda di garanzia allegata. Questo periodo è valido dalla data di acquisto; entro tale periodo, tutte le parti difettose saranno sostituite gratuitamente, a condizione che il difetto non sia la conseguenza di un incidente, un uso improprio o negligenza. L'assistenza secondo quanto stabilito dalla presente garanzia deve essere ottenuta dal fornitore dello strumento.

Il presente manuale è stato preparato ad uso dei clienti di Techne e niente di quanto in esso contenuto costituisce garanzia, condizione o rappresentanza riguardo la descrizione, la commerciabilità, l'idoneità allo scopo o altrimenti dell'unità o dei componenti.

Nonostante la descrizione e le specifiche dello strumento contenuti nel manuale dell'operatore, Techne si riserva il diritto di apportare le modifiche ritenute opportune agli strumenti o a qualsiasi loro componente.

INFORMACIÓN DE SEGURIDAD E INSTALACIÓN

Lea atentamente este manual antes de utilizar el Dri-Block® heater.

ADVERTENCIA

LAS ALTAS TEMPERATURAS SON PELIGROSAS, ya que pueden ocasionar quemaduras graves a los operarios y prender el material combustible. Techne ha puesto gran cuidado en el diseño de estos aparatos para proteger al usuario de cualquier peligro; aún así se deberá prestar atención a los siguientes puntos:



- TENGA CUIDADO Y LLEVE GUANTES DE PROTECCIÓN PARA PROTEGERSE LAS MANOS
- NO utilice sustancias combustibles cerca de objetos calientes
- NO utilice el instrumento cerca de líquidos o gases inflamables
- NO coloque un líquido directamente en el instrumento.

SEGURIDAD DEL OPERARIO

Todos los usuarios de equipos Techne deben disponer de la información necesaria para asegurar su seguridad. De acuerdo con las instrucciones contenidas en este manual y con las normas y procedimientos generales de seguridad, es muy importante que sólo personal debidamente capacitado opere estos aparatos. De no ser así, la protección que el equipo le proporciona al usuario puede verse reducida.

Todos los equipos Techne han sido diseñados para cumplir con los requisitos internacionales de seguridad y traen incorporados un sistema de desconexión en caso de sobre temperatura.

En caso de que surgiera un problema de seguridad, desconecte el equipo de la red.

INSTALACIÓN

El instrumento se debe transportar con las dos manos. No mueva ni lleve el instrumento cuando se utilice o esté conectado al suministro eléctrico principal.

1. Todos los instrumentos Techne se suministran con un cable de alimentación, que puede ser integrado o 'enchufable'.



2. Antes de conectar el instrumento al suministro eléctrico, compruebe que el voltaj coincida con el indicado en la placa de régimen (situada en la parte trasera de la unidad). **El instrumento debe disponer de una toma de tierra para garantizar la seguridad eléctrica adecuada.** Conecte el cable de alimentación a un enchufe adecuado según la siguiente tabla.

Conexión	230V, 50/60Hz	115V, 50/60Hz
Con corriente	Marrón	Negro
Neutro	Azul	Blanco
Toma de tierra	Verde/amarillo	Verde

Asegúrese de que los equipos marcados 230V en la placa indicadora funcionan a 207V y de que los equipos marcados 115V funcionan a 104V. No obstante, en ambos casos la velocidad de calentamiento se verá reducida en un 8% aproximadamente.

3. Sitúe la unidad sobre una mesa plana o en una campana de laboratorio si es necesario, y asegúrese de que los orificios de ventilación situados en la parte inferior no tienen ninguna obstrucción.
4. Conecte el cable de alimentación en el enchufe situado en la parte trasera del instrumento.
5. Encienda el instrumento:
 - I Interruptor de alimentación encendido
 - O Interruptor de alimentación apagado

Cable de repuesto

Si es necesario sustituir el cable de alimentación, se debe utilizar un cable de 1mm² de código armonizado H05VV, conectado a un enchufe IEC320. **EN CASO DE DUDA, PÓNGASE EN CONTACTO CON UN ELECTRICISTA.**

CONDICIONES AMBIENTALES

El Dri-Block[®] heater está diseñado para utilizarse en las condiciones siguientes:

- Uso en interior
- Intervalo de temperatura ambiente +5°C a +40°C
- Altitud: hasta 2000 m
- Humedad relativa no superior al 80%
- Fluctuaciones del suministro eléctrico no superiores al 10%
- Categoría de sobrevoltaje II IEC 60364-4-443
- Nivel de contaminación 2
- Separado de paredes u otros objetos a una distancia mínima de 200mm

Nota: Las especificaciones de control corresponden a una temperatura ambiental de 20°C. Las especificaciones pueden empeorar si se utiliza el instrumento fuera del intervalo de temperatura comprendido entre 10°C y 30°C.

Se han realizado pruebas para comprobar la interferencia de radiofrecuencia del instrumento, el cual cumple la normativa EN61326.

GARANTÍA

El instrumento está garantizado contra cualquier defecto en el material o la fabricación durante el período especificado en la tarjeta de garantía que se adjunta. Este período entra en vigor a partir de la fecha de compra. Durante este período, se reemplazarán sin cargo alguno todas las piezas defectuosas, a condición que el defecto sea resultado de un accidente, uso incorrecto o negligencia. El distribuidor del instrumento proporcionará información sobre las reparaciones realizadas bajo esta garantía.

Este manual se ha preparado con una finalidad informativa para los clientes de Techne y ninguna parte del manual se deberá considerar como una garantía, condición o reflejo con respecto a la descripción, comerciabilidad, idoneidad para un fin determinado o de otro tipo de la unidad o sus componentes.

Con independencia de la descripción y las especificaciones del instrumento que se indican en el manual del operario, Techne se reserva el derecho de realizar cambios en el instrumento o en cualquiera de sus componentes cuando lo estime oportuno.

CONTACT INFORMATION

For technical, sales or servicing information, contact your local Techne dealer or:

Cole-Parmer Ltd.

Beacon Road,
Stone,
Staffordshire,
ST15 0SA,
United Kingdom
Tel: +44 (0) 1785 812121
Email: cptechsupport@coleparmer.com
Email: cpsales@coleparmer.com
Email: cpsservice@coleparmer.com
Web: www.coleparmer.com

SPECIFICATIONS

DB100/2, DB100/3 AND DB100/4

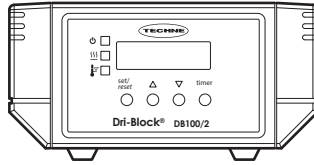

Specification	DB100/2 DB100/2/115	DB100/3 DB100/3/115	DB100/4 DB100/4/115
Number of insert blocks	2	3	4
Temperature display	5 character LED	5 character LED	5 character LED
Working temperature range	Ambient +5°C to 100°C	Ambient +5°C to 100°C	Ambient +5°C to 100°C
Minimum set temperature	0°C	0°C	0°C
Set point resolution	0.1°C	0.1°C	0.1°C
Set point accuracy at 37°C	±1°C	±1°C	±1°C
Set point accuracy at 100°C	±1.5°C	±1.5°C	±1.5°C
Temperature stability at 37°C	±0.1°C	±0.1°C	±0.1°C
Temperature stability at 100°C	±0.15°C	±0.15°C	±0.15°C
Max. temperature variation within a block	<0.2°C at 37°C <0.3°C at 100°C	<0.2°C at 37°C <0.3°C at 100°C	<0.2°C at 37°C <0.3°C at 100°C
Max. temperature variation between similar blocks	<0.5°C at 37°C <1.0°C at 100°C	<0.5°C at 37°C <1.0°C at 100°C	<0.5°C at 37°C <1.0°C at 100°C
Heat up time 25°C to 100°C	8 minutes	7 minutes	7 minutes
Countdown Timer with audible beeps	Yes	Yes	Yes
Minimum / Maximum timer	1min / 99h59min	1min / 99h59min	1min / 99h59min
Safety over-temp cut-out	Thermal fuse	Thermal fuse	Thermal fuse
Overall dimensions (W x D x H)	202 x 260 x 105mm	279 x 260 x 105mm	356 x 260 x 105mm
Electrical supply	230V or 115V, 50-60Hz	230V or 115V, 50-60Hz	230V or 115V, 50-60Hz
Power	300W	450W	600W
Shipping weight	5kg	6kg	7kg

Note: The control specifications are quoted for an ambient temperature of 20°C for units fitted with 2, 3 or 4 insert blocks type F3506. The specification will be closely held if the ambient temperature is in the range 10°C to 30°C. Outside this range the quoted figures may deteriorate but the unit will still work safely.

Note: Different block inserts may take different amounts of time to equilibrate to the same temperature.

DB200/2 AND DB200/3

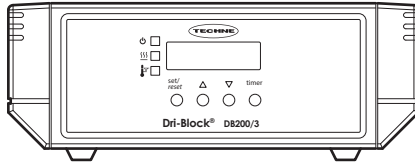

Specification	DB200/2 DB200/2/115	DB200/3 DB200/3/115
Number of insert blocks	2	3
Temperature display	5 character LED	5 character LED
Working temperature range	Ambient +5°C to 200°C	Ambient +5°C to 200°C
Minimum set temperature	0°C	0°C
Set point resolution	0.1°C	0.1°C
Set point accuracy at 37°C	≤±1°C	≤±1°C
Set point accuracy at 100°C	≤±1°C	≤±1°C
Temperature stability at 37°C	≤±0.1°C	≤±0.1°C
Temperature stability at 100°C	±0.15°C	±0.15°C
Max. temperature variation within a block	<0.2°C at 37°C <0.2°C at 100°C	<0.2°C at 37°C <0.2°C at 100°C
Max. temperature variation between similar blocks	<0.5°C at 37°C <1.5°C at 100°C	<0.5°C at 37°C <1.5°C at 100°C
Heat up time 25°C to 100°C	8 minutes	7 minutes
Heat up time 25°C to 200°C	23 minutes	19 minutes
Countdown Timer with audible beeps	Yes	Yes
Minimum / Maximum timer	1min / 99h59min	1min / 99h59min
Safety over-temp cut-out	Thermal fuse	Thermal fuse
Overall dimensions (W x D x H)	202 x 260 x 105mm	279 x 260 x 105mm
Electrical supply	230V or 115V, 50-60Hz	230V or 115V, 50-60Hz
Power	300W	450W
Shipping weight	5kg	6kg

Note: The control specifications are quoted for an ambient temperature of 20°C for units fitted with 2, 3 or 4 insert blocks type F3506. The specification will be closely held if the ambient temperature is in the range 10°C to 30°C. Outside this range the quoted figures may deteriorate but the unit will still work safely.

Note: Different block inserts may take different amounts of time to equilibrate to the same temperature.

DB100/2TC

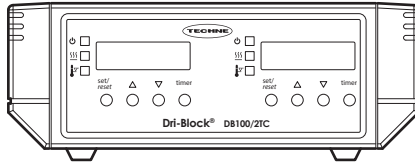

Specification

**DB100/2TC
DB100/2TC/115**

Number of insert blocks	2
Temperature display	5 character LED
Working temperature range "Temperature setting range"	Ambient +5°C to 100°C
Minimum set temperature	0°C
Set point resolution	0.1°C
Set point accuracy at 37°C	±1°C
Set point accuracy at 100°C	±1.5°C
Temperature stability at 37°C	±0.1°C
Temperature stability at 100°C	±0.15°C
Max. temperature variation within a block	<0.2°C at 37°C <0.3°C at 100°C
Max. temperature variation between similar blocks when set to the same temperature	<0.5°C at 37°C <1.0°C at 100°C
Heat up time 25°C to 100°C	8 minutes
Countdown Timer with audible beeps	Yes
Minimum / Maximum timer	1min / 99h59min
Safety over-temp cut-out	Thermal fuse
Overall dimensions (W x D x H)	279 x 260 x 105mm
Electrical supply	230V or 115V, 50-60Hz
Power	300W
Shipping weight	5kg

Note: The control specifications are quoted for an ambient temperature of 20°C for units fitted with 2, 3 or 4 insert blocks type F3506. The specification will be closely held if the ambient temperature is in the range 10°C to 30°C. Outside this range the quoted figures may deteriorate but the unit will still work safely.

Note: Different block inserts may take different amounts of time to equilibrate to the same temperature.

OPERATION

INSTALLATION

See also the sections on **Safety and Installation**.

1. Place the unit on a suitable flat bench or in a fume cupboard if required, ensuring that the air inlet vents on the underside are free from obstruction.
2. Select the insert aluminium alloy block(s) appropriate for the application. A list of available blocks is given in the section 'Accessories'. Ensure that both the underside of the block(s) and the top of the hotplate are clean; efficient heat conduction between these two surfaces is essential.

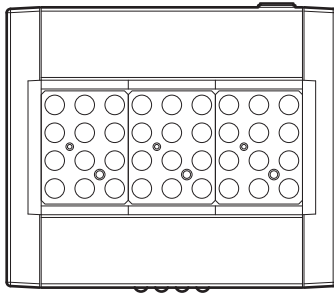

Top view showing three insert blocks in place

3. Place the insert blocks onto the hotplate in the well of the unit and place the tubes containing the sample liquid in the blocks.
4. The heater design, temperature sensor and control circuit give good temperature control and uniformity, but it is important that there is a close fit of the tubes in the block to allow efficient heat transfer.
5. If less than the maximum number of insert blocks are fitted it is recommended that plastic half blocks (part code F4466) are fitted to the space either side of the aluminium block. The half blocks have the effect of reducing heat loss, thus improving temperature stability.

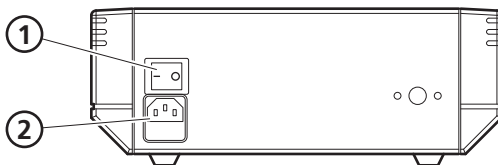

Rear view

1. Power ON/OFF switch.
2. Mains cable socket.

- Plug the mains cable into the socket in the rear of the unit. Connect to the mains electricity supply with the plug provided or one wired correctly for your supply. Switch the power ON from the switch located next to the mains input lead. The front display will then light up.

POWER UP SCREEN

When you first switch on, the display will initially flash the currently installed firmware version of the unit. It will display this for 1 second and then the actual temperature of the plate will be indicated.

THE FRONT PANEL CONTROLS

The front panel controls consist of four buttons for controlling the display, a five digit LED display and three indicators.

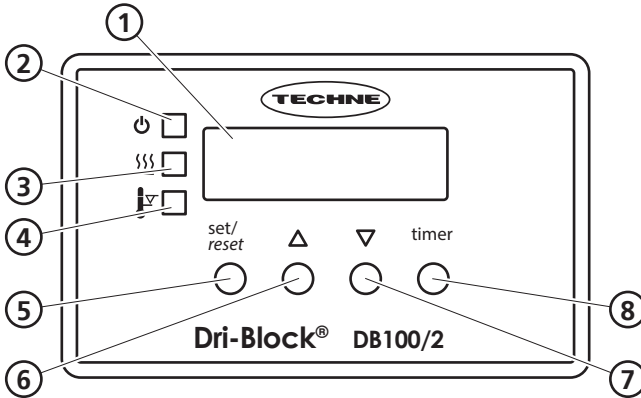

The front panel controls

- Five digit LED display.
- Power indicator. When lit, this shows that there is power to the unit.
- Heater indicator. When this is flashing, it indicates that the heater is heating the unit or controlling the temperature. If the Dri-Block® is above the set temperature then the indicator will be off.
- Over-temperature indicator. If this is lit, it indicates that the unit has developed a fault and the over-temperature cut-out has been triggered. This will cause the heater to be switched off and the unit will begin to cool even if the heater light is on. The unit should be returned to Cole-Parmer or its authorised agent for investigation.
- Set/reset. Press to show the set temperature. If the timer is activated, pressing and holding this button deactivates the timer. This button also silences the beeper.
- Up arrow button. Used together with the set/reset button or timer button to increase the set temperature or time. Used together with the Down arrow button, this button can be used to change the temperature display from °C to °F.
- Down arrow button. Used together with the set/reset button or timer button to decrease the set temperature or time.
- Timer. Press to set or activate the timer. This button also silences the beeper.

SETTING THE TEMPERATURE UNITS

1. Press the Up arrow and Down arrow buttons together to toggle between °F and °C.

Note: When the unit is tuned off, on subsequent power-up the units will revert to °C.

SETTING THE OPERATING TEMPERATURE

1. To display the set temperature on the digital display, press and hold the set/reset button.
2. To adjust the set temperature, press the set/reset button and hold it while pressing the Up or Down arrow buttons. Each press of the Up arrow or Down arrow buttons will increase or decrease the set temperature by 0.1°C. If the buttons are held down the temperature change will accelerate to 20°C per second.
3. When the set/reset button is released, the current heater temperature is displayed.
4. The heater indicator will flash if the new set temperature is higher than the current heater temperature and will continue to flash to show that the unit is controlling the temperature.
5. The heater indicator will turn off if the new set temperature is lower than the current heater temperature and will only start to flash when approaching the set temperature.
6. For optimal accuracy, allow the block inserts to equilibrate to the set temperature for about 30 minutes.

DB100/2TC

The model D100/2TC accommodates 2 aluminium blocks with independent temperature controls so that each block may be set to a different temperature. The operation of the controls for each block is as described above.

If using this model with only one block in place, the side with no block should have its set temperature adjusted to 30°C.

Note: Due to variations in heat losses with different designs of insert block, the actual temperature may vary. The units are calibrated using model F3506 insert blocks. If you need to control the temperature to a greater accuracy than the instrument's set point, place a thermometer in a designated hole in one of the blocks. For greater accuracy still, you can place a thermometer in the sample liquid in one of the test tubes.

In either of these cases, it may be necessary to readjust the set temperature to achieve the precise temperature required. Allow the temperature of the unit to stabilise after each adjustment. There will be a time lag between the heater plate and the insert block achieving the set temperature due to the thermal contact between them.

SETTING THE TIMER

1. To set the timer, press and hold the timer button and press the Up or Down arrow buttons. Each press of the Up arrow or Down arrow buttons will increase or decrease the set time by 1 minute. If the buttons are held down, the time change will accelerate to 200 min per second.
2. Release the timer button to activate the timer. An audible beep will be heard once the timer is activated.
3. When the count-down time has completed, an audible beep will be heard and the display will show the word 'End' alternatively with the current heater temperature. Press the set/reset button to cancel the beeper. The unit will start to cool to ambient once the count-down time has completed.

4. To stop the timer at any point during the count-down period, press and hold the set/reset button or the timer button until the word 'Stop' appears and an audible beep is heard.
5. To display the current heater temperature while the timer is active, press the timer button. The display will show the heater temperature and the letter 't' will flash on the left hand side indicating the timer is counting down. Press the timer button again to revert to the timer count-down.
6. To re-run the same timer count-down, press the timer button until an audible beep is heard.
7. To turn the timer function off, press and hold the timer button and press the Down arrow button until the word 'OFF' appears.

AFTER USE

When you have finished heating samples, remember that parts of the unit – the tubes, blocks and associated accessories – may be very hot. Take the precautions listed in the section Safety and Installation. We recommend that the blocks should be allowed to cool to 70°C or below before being removed from the heating unit.

To remove an insert block, screw the extractor tool into the threaded hole and lift the block out vertically. Never leave the extractor tool in the block while it is being used in the Dri-Block[®] heater.

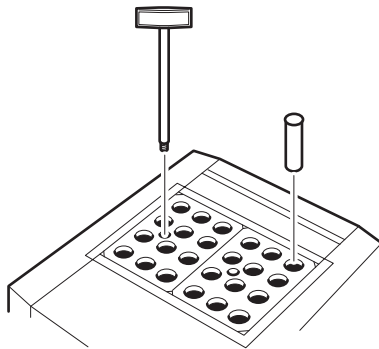

Removing an insert block with the extractor tool

USER MAINTENANCE

Before cleaning your unit, disconnect it from the power supply. The outer case of the Dri-Block[®] heater may be cleaned with a cloth dipped in water or ethanol (methanol can also be used). No part of the case or cover should be immersed in the solvents. Do not use aggressive solvents such as acetone or abrasive cleaners. Do not use bleach or strong acids.

Before using any cleaning or decontamination method except those recommended here, the responsible person should check with Techne that the proposed method will not damage the equipment.

CALIBRATION

Note that if you change the calibration from that set at the factory you may change the calibration at all temperatures. You may get different calibration with different blocks.

Make sure that you have good thermal contact between the insert blocks and the heater plate in the Dri-Block[®] heater. For best results, push all the block inserts to the right hand side so they are touching. In order to ensure that the calibration you are setting is correct, you will need to use an independently calibrated temperature probe or thermometer.

First, measure the actual temperature of the particular block you want to use in the Dri-Block[®] heater using the calibrated probe or thermometer. If the calibration is not correct then you can follow the procedure outlined below. Before you begin, make sure that the block and the unit are below 35°C.

1. Set the temperature display to the lowest setting. This will ensure that the block is at ambient temperature for the next procedure.
2. Insert your calibrated probe or thermometer into the thermometer hole of the right hand block insert. A little silicone oil can be placed in the hole if necessary to give a better heat transfer.
3. Press and hold the Down arrow button then press the Up arrow button. The word 'CAL' will be shown on the display. The unit will now heat to 40°C and stabilise for 30 minutes.
4. After a period of 30 minutes the unit will beep and the display will change to show the word 'rEAdy'. Measure the actual temperature of the block using the thermometer or probe.
5. Press the set/reset button and using either the Up arrow or the Down arrow buttons, adjust the display to show the same temperature as the value measured by the thermometer.
6. Press and hold the set/reset button then the timer button. The unit will beep and proceed to the next calibration temperature. With the DB100 units the second calibration temperature is 95°C and with the DB200 units the temperature is 195°C. The unit will now heat and stabilise for 30 minutes.
7. After a period of 30 minutes the unit will beep and the display will change to show the word 'rEAdy'. Measure the actual temperature of the block using the thermometer or probe.
8. Press the set/reset button and using either the Up arrow or the Down arrow buttons, adjust the display to show the same temperature as the value measured by the thermometer.

Note: Up to this point it is possible to cancel the calibration by turning the unit off.

9. To complete the calibration procedure, press and hold the set/reset button then the timer button. The unit will beep and the word 'done' will briefly flash on the display. The unit will return to normal operation.

Note: The calibration routine for the DB100/2TC is the same as above except each block position should be calibrated separately.

Note: Aluminium block inserts are designed to allow for thermal expansion up to 200°C. For this reason there will be a small air space around the blocks at ambient temperature. The heat source is the base of the Dri-Block[®] heater. For best results push all the block inserts to the right hand side so they are touching.

ADDITIONAL INFORMATION

Note that this equipment should only be dismantled by properly trained personnel. Removing the outer cover exposes potentially lethal mains voltages. There are no user serviceable parts within this equipment.

FAULT FINDING

Should you have any problems with your Dri-Block[®] heater which cannot be easily remedied, you should contact your supplier and return the unit if necessary. Please include details of the fault observed and remember to return the unit in its original packing. Cole-Parmer Ltd. accepts no responsibility for damage to units which are not properly packed for shipping: if in doubt, contact your supplier, giving the full serial number of the unit.

FUSES

If the display on the front panel is not lit, one of the two fuses may have blown. Check that there is no external cause, such as a faulty plug or lead. Check both fuses and replace the faulty fuse with a new one of the correct value (fuse values are given on the label next to the power inlet). Note that fuses should only be replaced by a qualified electrician.

The holder for the two fuses is built into the mains input socket. First remove the power cable and then gently prise the fuse drawer open with a flat-bladed screwdriver or similar tool. Each fuse can be removed by using the screwdriver as a lever.

Exchange the faulty fuse in the fuse holder for a working fuse of the correct value. Finally, replace the fuse drawer in the fuse compartment and push the drawer shut. Fuses which blow repeatedly indicate a serious fault and you should return the unit to your supplier for repair.

Model	Fuses for 230V	Fuses for 115V
DB100/2	2 x 3.15 Amp	2 x 4.00 Amp
DB100/3	2 x 3.15 Amp	2 x 6.30 Amp
DB100/4	2 x 4.00 Amp	2 x 6.30 Amp
DB200/2	2 x 3.15 Amp	2 x 4.00 Amp
DB200/3	2 x 3.15 Amp	2 x 6.30 Amp
DB100/2TC	2 x 3.15 Amp	2 x 4.00 Amp

SAFETY OVER-TEMPERATURE CUT-OUT

In the event of a fault occurring which could cause the heater to over-heat, a thermal fuse will cut in and remove power from the heater. This will occur when the temperature reaches approximately 192°C in the DB100 models and 240°C in the DB200 models.

SUPPORT CONTACTS

If you require further technical or application assistance please contact Techne at:

E-mail: cptechsupport@coleparmer.com

Phone: +44 (0)1785 812121

For servicing information please contact:

Cole-Parmer Ltd.

Service Department,

Beacon Road,

Stone,

Staffordshire,

ST15 0SA,

E-mail: cpsevice@coleparmer.com.

Phone: +44 (0)1785 812121

We are continually striving to improve our products and software. If you have any comments and suggestions on how we can do things better please send them to us at: cptechsupport@coleparmer.com

TECHNE DRI-BLOCK INSERTS

Insert blocks are made of aluminium alloy and must be ordered separately from the heater units.

Part code	Nominal tube size	Number of holes	Hole diameter (mm)	Hole depth (mm)	Base profile	Block dimensions (mm)
F3501	Plain block (single)	None	-	-	-	95 x 75 x 50
F3502	6mm	30	6.5	38	Conical	95 x 75 x 50
F3503	10mm	20	10.5	48	Conical	95 x 75 x 50
F3504	12mm	20	12.75	48	Conical	95 x 75 x 50
F3505	13mm	20	13.8	48	Conical	95 x 75 x 50
F3506	15mm	12	15.75	48	Conical	95 x 75 x 50
F3507	16mm and 15ml Falcon tubes	12	16.75	48	Conical	95 x 75 x 50
F3508	19mm	8	19.75	48	Conical	95 x 75 x 50
F3509	25mm	6	25.75	48	Conical	95 x 75 x 50
F3510	10mm Cuvettes	2 channels	13 x 95	38	Flat	95 x 75 x 50
F3512	Plain block (triple)	Thermometer only	-	-	-	95 x 225 x 50
F4460	Plain block (single)	Thermometer only	-	-	-	95 x 75 x 50
F4461	7mm and 9mm	20 + 10	7.0 and 9.5	38	Conical	95 x 75 x 50
F4462	24mm	6	24.75	48	Conical	95 x 75 x 50
F4463	26mm	6	26.75	48	Conical	95 x 75 x 50
F4464	1.5ml Microfuge tubes	20	10.9	35	Tapered	95 x 75 x 50
F4465	0.5ml Microfuge tubes	30	7.9	27	Tapered	95 x 75 x 50
F4466	Half block plastic spacers	-	-	-	-	98.8 x 40.2 x 18.5
F4470	2.0ml Microfuge tubes	20	10.8	35	Conical	95 x 75 x 50
F4471	0.2ml Microfuge tubes	72	4.4	13.8	Tapered	95 x 75 x 50
F4472	5ml Eppendorf tubes	12	17.0	48	Tapered	95 x 75 x 50
F4473	96-Well PCR plate	96	5.5	17.3	Tapered	95 x 150 x 61
F4476	Gelation timer sample cup	1	46.5	48	Flat	95 x 75 x 50
F4477	384-Well PCR plate	384	3.57	7	Tapered	95 x 150 x 61
F4480	50ml Falcon tubes	5	28.9	48	Conical	95 x 75 x 50
F4481	96-Well flat-bottom plate	Rectangular ridge	-	48	Flat	95 x 150 x 61

Part code	Nominal tube size	Number of holes	Hole diameter (mm)	Hole depth (mm)	Base profile	Block dimensions (mm)
F4485	30mm tubes	5	30.5	48	Conical	95 x 75 x 50
F4487	43mm vessels	2	43.8	45	Flat	95 x 75 x 50
F4490	20mm tubes	8	20.75	48	Conical	95 x 75 x 50
F4501	12mm Vials	20	12.75	25	Conical	95 x 75 x 50
F4515	20mm Vials (triple)	18	20.2	35	Flat	95 x 225 x 50
F4516	23mm Vials (triple)	18	23.2	35	Flat	95 x 225 x 50
F4567	12mm Vials	20	12	24	Flat	95 x 75 x 50
F4568	15mm Vials	12	15.75	30	Flat	95 x 75 x 50
F4569	12mm Vials	20	12.75	20	Flat	95 x 75 x 50
F4675	16mm Vials	12	16.75	35	Flat	95 x 75 x 50
F4676	13mm Vials	20	13.8	25	Flat	95 x 75 x 50
F4677	17mm vials	12	17.2	48	Flat	95 x 75 x 50
FLEXI2	Any (beads)	1	83 x 138	44	Flat	95 x 150 x 50
FLEXI3	Any (beads)	1	83 x 213	44	Flat	95 x 225 x 50

REPLACEMENT PARTS

The following replacement parts can be obtained from Cole-Parmer Ltd. or your Techne dealer:

Product code	Description
HH179(S)	UK mains lead with plug, 230V
HH180(S)	European mains lead with plug, 230V
FCABLEUS	US mains lead with plug, 115V
6101308	Spare block extraction tool

CE This product meets the applicable EC harmonized standards for radio frequency interference and may be expected not to interfere with, or be affected by, other equipment with similar qualifications. We cannot be sure that other equipment used in its vicinity will meet these standards

and so we cannot guarantee that interference will not occur in practice. Where there is a possibility that injury, damage or loss might occur if equipment malfunctions due to radio frequency interference, or for general advice before use, contact the manufacturer.



EU Declaration of Conformity

Product	Laboratory Equipment	File Number	P225
Manufacturer	Cole-Parmer Ltd Beacon Road Stone, Staffordshire ST15 0SA United Kingdom		

This declaration of conformity is issued under the sole responsibility of the manufacturer

Object of Declaration Dri-Block Heater - DB Digital
(reference the attached list of catalogue numbers)

The object of the declaration described above is in conformity with the relevant Union Harmonisation Legislation:

Low Voltage Directive	2014/35/EU
EMC Directive	2014/30/EU
RoHS Directive	2011/65/EC

References to the relevant harmonised standards used or references to the other technical specifications in relation to which conformity is declared:

IEC/EN 61010-1:2010	Safety requirements for electrical equipment for measurement, control and laboratory use. Part 1: General requirements.
IEC/EN 61010-2-010:2014	Particular requirements for laboratory equipment for the heating of materials.
IEC/EN 61326-1:2013	Electrical equipment for measurement, control and laboratory use. EMC requirements. Part 1: General requirements (Class A).

Signed for and on behalf of the above manufacturer

Additional Information Year of CE Marking: 1996

Place of Issue Stone, Staffordshire, UK

Date of Issue 03 January 2017

Authorised Representative Steve Marriott

Title Technical Director

Signature



Cole-Parmer Ltd - UK

Beacon Road,
Stone,
Staffordshire,
ST15 0SA,
United Kingdom
Tel: +44 (0)1785 812121
Email: cpinfo@coleparmer.com
Web: www.techne.com