

# WNB



## OPERATING INSTRUCTIONS

Waterbaths

**WNB 7 - 45**

1	General notes and safety notes.....	3
1.1	Transport.....	3
2	Technical data .....	4
2.1	Material quality .....	5
2.2	Electrical equipment .....	5
2.3	Note on EMC (electromagnetic compatibility).....	5
2.4	Brief technical description .....	5
2.5	Standard equipment.....	6
3	Installation.....	6
3.1	Initial start-up.....	7
3.2	Start-up - waterbath.....	7
4	Bath construction and operation .....	8
4.1	Controls and indications .....	8
4.2	Switching on .....	9
4.3	Setting the parameters .....	9
4.3.1	Temperature setpoint.....	10
4.3.2	Delayed switch-on .....	10
4.3.3	Hold time of the setpoint temperature.....	11
5	Programming example of a programme sequence .....	11
6	Monitoring the programme sequence .....	12
7	Temperature monitor and protection devices .....	13
7.1	Mechanical temperature monitor: temperature limiter.....	13
7.2	Low-level protection .....	13
7.3	Monitor relay.....	13
8	Use of the cover (special equipment) .....	14
9	Level control (special equipment).....	14
10	Cooling system (special equipment).....	15
11	Cleaning and maintenance.....	15
12	Check list for fault rectification .....	16
13	Action on supply failure .....	16
14	Glossary .....	16
15	CE Conformity of Declaration .....	17
16	Address and customer service.....	18
17	Index .....	19

## 1 General notes and safety notes

You have purchased a technically fully proven product which has been produced in Germany with the use of high-grade materials and the application of the latest manufacturing techniques; it has been factory tested for many hours.

For this waterbath we guarantee spare parts to be available up to 10 years.



Observation of the Operating Instructions is necessary for faultless operation and for any possible claims under warranty. If these Instructions are disregarded, all claims under warranty, guarantee and indemnification are excluded!



This mark on the product means:  
Note Operating Instructions  
Warning – bath hot when operating

The right to technical modifications is reserved.  
Dimensional details are not binding.

### 1.1 Transport

Always use gloves!

If the units WNB 22 to 45 have to be carried, 2 persons are required.



Place the bath accurately horizontal and not on an inflammable support!

## 2 Technical data

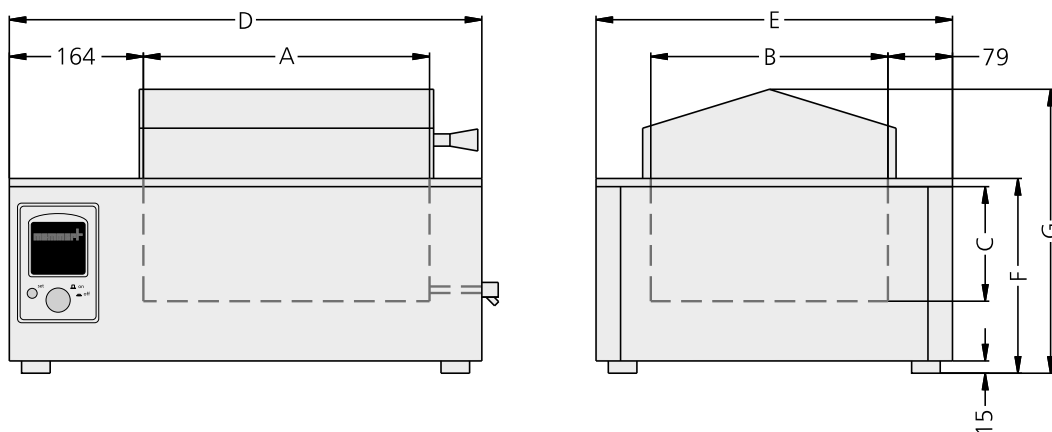

Model	7	10	14	22	29	45
Volume [liter]	7	10	14	22	29	45
Usable bath length A [mm]	240	350	350	350	590	590
Usable bath width B [mm]	210	210	290	290	350	350
Usable bath depth C [mm]	140	140	140	220	140	220
Housing length D [mm]	468	578	578	578	818	818
Housing width E [mm]	356	356	436	436	516	516
Housing height (with flat cover) F [mm]	238	238	238	296	238	296
Housing height (with gable cover) G [mm]	337	337	347	405	343	401
Weight [kg]	11	14	16	17	24	26
Current consume [A]	5,2	5,2	7,8	8,7	10,4	12,2
Power [W]	1200	1200	1800	2000	2400	2800
Ambient conditions	Ambient temperature 5°C - 40°C rh max. 80% (no condensation) Overvoltage Category: II Contamination degree: 2					
Setting temperature range	10°C to 95°C with activation of the boiling mode up to 100°C, see section 4.3.1					
Setting accuracy	0,1°C					
Indication accuracy	0,1°C					
Working temperature range	5°C above ambient temperature to nominal temperature = maximum temperature (see rating plate)					

## 2.1 Material quality

Memmert is using stainless steel (Mat.Ref. 1.4301) for the external casing as well as for the interior, an outstanding material because of its high stability, optimum hygienic features and corrosion resistance against many (not all!) chemical combinations (Attention e.g. at chlorine combinations!).

The load has to be tested for its chemical compatibility with the materials mentioned above. A material-compatibility table covering all these materials can be requested from MEMMERT.



**WARNING! Always pull out the supply plug before opening the bath cover!**

## 2.2 Electrical equipment

- Operating voltage see rating label, 50/60 Hz
- Protection Class 1, i.e. operating isolation with ground connection to EN 61 010
- Protection IP20 to DIN EN 60 529
- Interference suppression to EN55011 Class B
- Bath protected by a fuse 250V/15A fast blow
- Controller protected by a 80 mA fuse (200 mA on 115 V)
- When connecting a MEMMERT bath to the electrical supply you have to observe any local regulations which apply (e.g. in Germany DIN VDE 0100 with FI protection circuit)

## 2.3 Note on EMC (electromagnetic compatibility)

This product is intended to operate on a supply network with a system impedance  $Z_{max}$  at the transfer point (building connection) of 0.292 Ohm max. The user has to ensure that the product is only operated on an electrical supply network which meets these requirements. If necessary, details of the system impedance can be obtained from the local electricity supply authority.



**Note:**  
**Any work which involves opening up the bath must only be carried out by a properly qualified electrician!**

## 2.4 Brief technical description

MEMMERT-waterbaths are electrically heated and electronically controlled.

The temperature of the thermostating liquid is continuously controlled by a microprocessor-controller with pulse package control. Electronic microprocessor-PID-controller with continuous power matching and autodiagnostic system with fault indicator (see section 12), integral timer for digital programme time selection.

The temperature is measured using a Pt 100 temperature sensor (4-wire circuit). The accuracy is as follows:

	WNB
Setting accuracy	0,1°C
Temperature fluctuation	±0,1°C

The components of temperature control are controlled by integrated malfunction-recognition. The heaters are installed outside - therefore no problems through dirt or limeresidue.

## 2.5 Standard equipment

- Electronic fuzzy-supported PID process controller with delayed programme start and programmable hold time. The controller has permanent power matching and an autodiagnostic system for rapid fault finding
- Recessing push/turn control for simple operation of bath
- Visual alarm indication
- Mechanical temperature limiter (TB Class 1)
- Monitor relay to switch off heating in case of fault
- High-grade stainless-steel Pt100-temperature sensor (Mat.Ref. 1.4571) Class A in 4-wire circuit
- Boiling mode for temperatures above 95°C

Special equipment (to be ordered separately as accessory): flat cover with concentric ring sets, gable cover to drain condensate, cooling device, various racks for test tubes, bottles etc

## 3 Installation

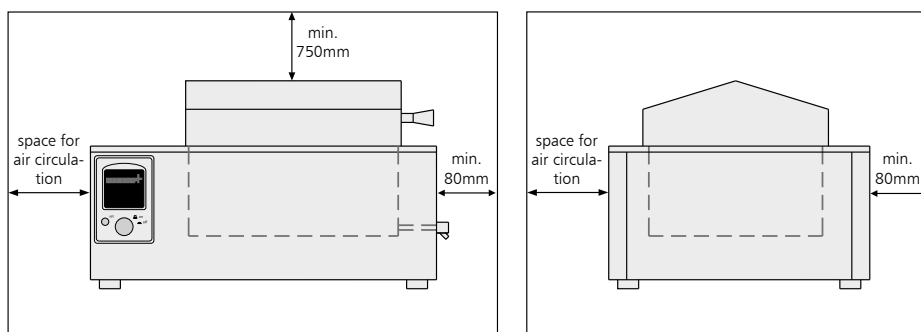

The unit must be placed on a **horizontal, non-flammable surface** which cannot tilt.

The vent openings in the left and back side **must** remain unobstructed. Minimum wall spacing on all sides is 80 mm. The minimum spacing from the top of the bath to the next ceiling (rack, etc.) is 750 mm.

### 3.1 Initial start-up

When the bath is started up for the first time, it should be supervised continuously until steady conditions have been reached.

### 3.2 Start-up - waterbath

**Mains connection** The mains connection cable must be placed away from any hot surface.

**Filling**

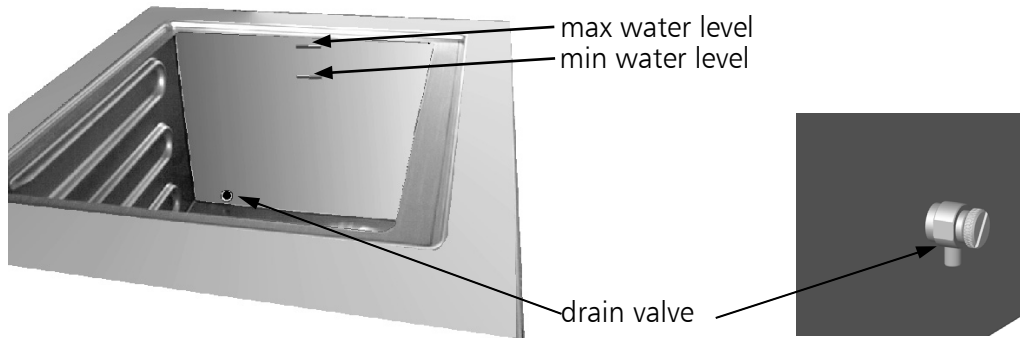

In order to guarantee the high quality of the stainless steel it is recommended by the steel producer to fill the waterbath with deionised water.



**IMPORTANT! The bath has to be filled up to a level between the two markings at the right side of the tub!**  
**Waterbaths can be fitted with a level control system (see section 9).**

**Draining**

The tank can be drained through the drain valve. The thermostating fluid must be cooled to room temperature before draining. Drain the fluid either directly into an appropriate container or connect an appropriate hose to the drain valve.



**NOTE: Polluted fluids may not be drained directly into the public wastewater system! If the thermostating fluid is polluted, please make sure that it will be properly filtered or dumped according to the applicable regulations!**



**Operation with non-flammable thermostating liquids only!**

## 4 Bath construction and operation

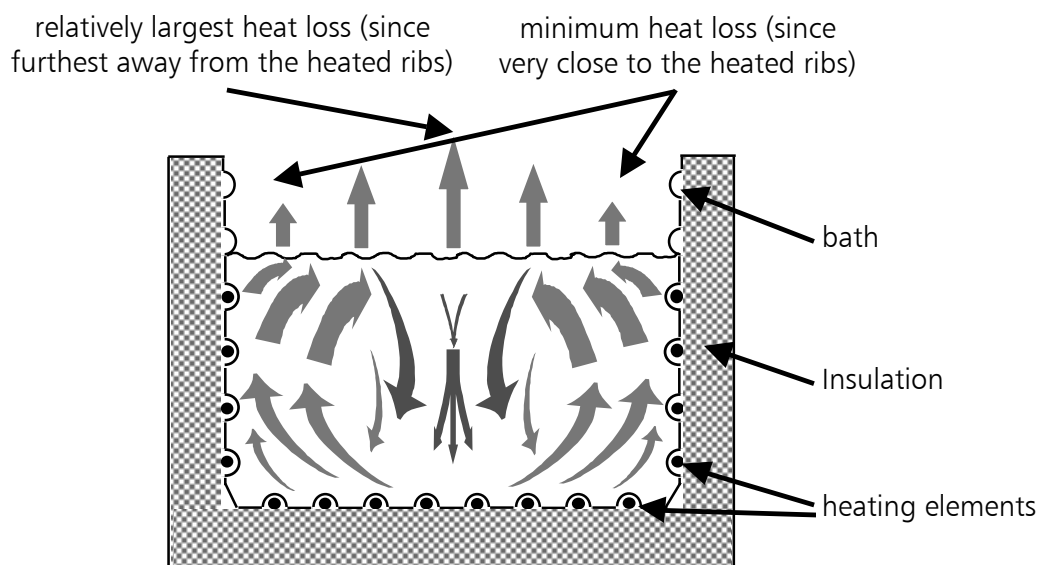

The heating positioned on three sides around the tank ensures a natural water circulation of the liquid inside, thus securing an optimal uniform temperature distribution.

### 4.1 Controls and indications

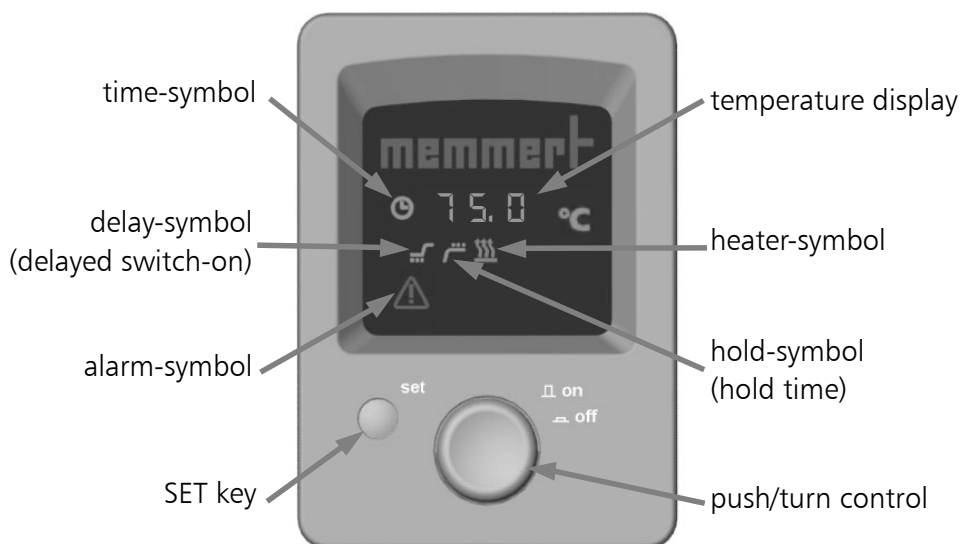



## 4.2 Switching on

The bath is switched on by pressing the push/turn control



and can be operated in connection with the SET-key.



Bath switched off: The push/turn control is pushed in and protected against damage.

## 4.3 Setting the parameters

A parameter can be selected by rotating the push/turn control; all other parameters are then dimmed. The selected parameter flashes brightly and can now be altered with the push/turn control while holding down the SET key (protection against unintentional alteration).

If the push/turn control is rotated quickly the setpoint is altered in large steps; with slow operation it is altered in single steps.

After the SET key has been released the newly set value is stored.

Further rotation of the push/turn control selects the next parameter.

Rotation of the push/turn control selects the following parameters (in the order indicated), to be altered as described above:

1. Temperature setpoint
2. Delayed switch-on
3. Hold time of the setpoint temperature

### 4.3.1 Temperature setpoint

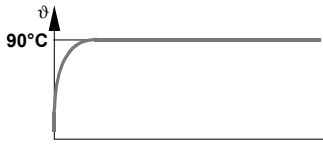



The bath starts to heat up immediately to the set temperature.

Adjustment range:

10°C to 95°C or ca. 100°C with activation of the boiling mode

Setting and indication accuracy:

0,1°C

<p>Rotate the push/turn control until the °C symbol flashes.</p> <p>The setpoint temperature can then be selected with the SET key depressed, as described in section 4.3. After releasing the SET key the display briefly flashes the setpoint. The display then changes to the actual temperature and the controller starts to control to the selected setpoint temperature.</p> <p>During heating the  symbol flashes in proportion to the actual heater power.</p> <p>In order to reach water temperatures above 95°C (boiling point), waterbaths are provided with the boiling mode. If this is selected, the heating is switched on permanently.</p> <p>Activating the boiling mode by rotating the push/turn control beyond the maximum value until the display shows "LLL"</p> <p>The setting "boiling mode" is not stored permanently. After the bath is switched off and on again, the controller shows again the previously selected setpoint.</p>	  
--	--

### 4.3.2 Delayed switch-on

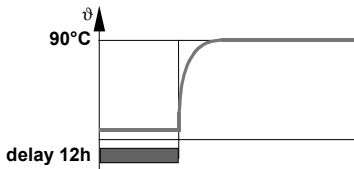

The bath starts to heat up to the previously selected temperature only after the time of the switch-on delay has elapsed.

Adjustment range:

1 min bis 99.99 hrs





Setting accuracy:

1 min

Indication accuracy:

< 10 hrs: 1 min

≥ 10 hrs: 1 hr

<p>Rotate the push/turn control until the  (delay) and the  symbol flashes.</p> <p>The duration of the delayed switch-on can then be set with the SET key depressed as described in section 4.3. After the SET key has been released the bath briefly flashes the setting of the switch-on delay.</p> <p>The delayed switch-on is then activated and the display alternates between the actual temperature and the running time of the switch-on delay. The time is shown with a negative sign and runs down. In this way it is possible to determine at any time how much longer the bath waits until it begins to heat up.</p> <p>If no delayed switch-on is required, it can be de-activated by the setting "OFF".</p>	    
---	---

### 4.3.3 Hold time of the setpoint temperature

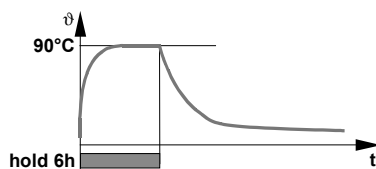

The bath switches off the heating after the end of the selected hold time. In this case the hold time includes the heating-up time.

Adjustment range:

1 min bis 99.99 hrs





Setting accuracy:

1 min





Indication accuracy:

< 10 hrs: 1 min





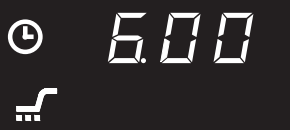

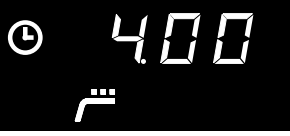



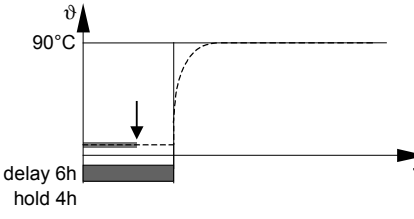

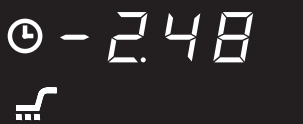

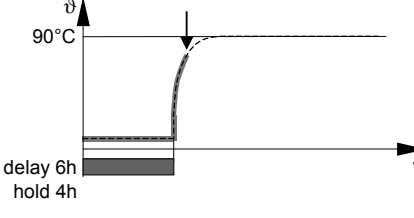

≥ 10 hrs: 1 hr

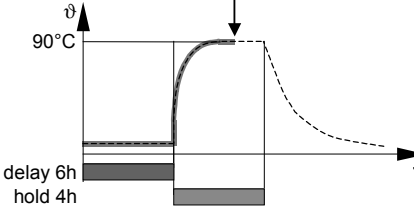
<p>Rotate the push/turn control until the  (hold) and the  symbol flashes.</p> <p>The duration of the hold time can then be selected with the SET key depressed, as described in section 4.3. After the SET key has been released the bath briefly flashes the hold time setting.</p> <p>If no hold time has been programmed, the hold time is activated immediately and the display alternates between the actual temperature and the running time of the hold time. As with switch-on delay, the residual time is shown with a negative sign and runs down.</p> <p>If no hold time is required, it can be de-activated by the setting "OFF"</p>	  
---	--

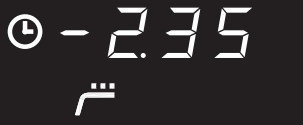
### 5 Programming example of a programme sequence

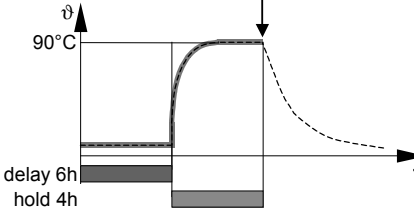
<p><u>1. Setpoint temperature setting</u></p> <p>Rotate the push/turn control until the °C symbol flashes. With the SET key depressed, use the push/turn control to set the temperature setpoint to f.ex. 99.9 °C.</p>	
<p><u>2. Delayed switch-on setting</u></p> <p>Rotate the push/turn control until the  (delay) and the  symbol flashes. With the SET key depressed, use the push/turn control to set the time f.ex. 6.00 hours.</p>	
<p><u>3. Hold time setting</u></p> <p>Rotate the push/turn control until the  (hold) and the  symbol flashes. With the SET key depressed, use the push/turn control to set the time f.ex. 4.00 hours.</p>	

## 6 Monitoring the programme sequence

 <p>90°C delay 6h hold 4h</p> <p>Bath does not heat up</p>	<p>During the delayed switch-on the  symbol flashes and the display alternates between residual time and actual temperature</p>	 <p>↑</p> 
 <p>90°C delay 6h hold 4h</p> <p>Bath heats up</p>	<p>After the end of the delayed switch-on the  symbol goes dark and the bath heats up to the selected setpoint temperature. Heating is indicated by the  symbol.</p>	
 <p>90°C delay 6h hold 4h</p> <p>Bath holds setpoint temperature</p>	<p>During the hold time the  symbol flashes and the display alternates between the residual time and the actual temperature.</p>	 <p>↑</p> 
 <p>90°C delay 6h hold 4h</p> <p>Heating is switched off</p>	<p>After the hold time has elapsed the  symbol goes dark, the heating is switched off, and the display alternates between the actual temperature and "END".</p>	 <p>↑</p> 

## 7 Temperature monitor and protection devices

### 7.1 Mechanical temperature monitor: temperature limiter

All waterbaths are fitted with a mechanical temperature limiter (TB) Protection Class 1 to DIN 12880.

If the electronic control unit should fail during operation and the fixed factory-set maximum temperature is exceeded by approx. 30°C the temperature limiter switches off the heating permanently as a final protective measure. The  symbol lights up continuously as warning.

### 7.2 Low-level protection

In addition to its function as overtemperature protection the TB also operates as low-level protection, i.e. the heating is switched off permanently if the liquid drops below a certain level. As a warning the  symbol lights up continuously.

Fault rectification after the TB cut-out has been activated:

1. Switch off the bath and allow it to cool down
2. Rectify the fault (e.g. top up the liquid, replace temperature probe) and where appropriate contact customer service
3. The bath is again ready for operation only after it has cooled down and after the fault has been rectified

### 7.3 Monitor relay

In addition the bath is equipped with an electronic monitor relay.

If a fault occurs during operation or if the selected setpoint temperature is exceeded by 10°C, then the monitor relay continues control of the heating at this temperature in emergency operation.

The  symbol flashes as warning.

Fault rectification after the monitor relay may been activated:

Check the controller for error messages (see section 12) and where appropriate contact customer service.

Example:

With a setpoint temperature of 80°C, if a fault occurs in the power unit (faulty triac) the bath continues to operate in emergency operation at approx. 90°C.

## 8 Use of the cover (special equipment)

Gable cover The gable cover (may be ordered as already mounted special equipment) should always be closed in order to prevent evaporation of thermostating liquid and to obtain optimal temperature distribution. The gable shape of the cover makes sure that condensed water will not drop down into the loads.

Flat cover For positioning of test flasks on top of the bath, a flat cover (special equipment) may be used. The size of the holes in this cover can be adapted to the flasks with ring inserts. The rings may therefore only be inserted or taken off, if the bath is cooled down.



**Note that during operation the flat cover and the gable cover heat up to the temperature of the thermofluid!**

## 9 Level control (special equipment)

2 different filling levels can be maintained constant if the unit is fitted with a level control system. When using water as thermostating liquid, connect the feed pipe with tubing to the mains water supply. The drain must be connected with tubing to an appropriate container or sink.

Make sure, that the tubing cannot be clogged or bended, and that it continually runs downhill.

**Please note, that the outflowing water may be hot!**

Supply and drain are identified by arrows. Use temperature resistant material for the tubing.

If the second overflow is not required, it must be closed with a sealing cap.

The evaporation loss can be compensated through a slightly open water supply (dripping) and can be monitored through the "observation window".

The level control system cannot be retrofitted!

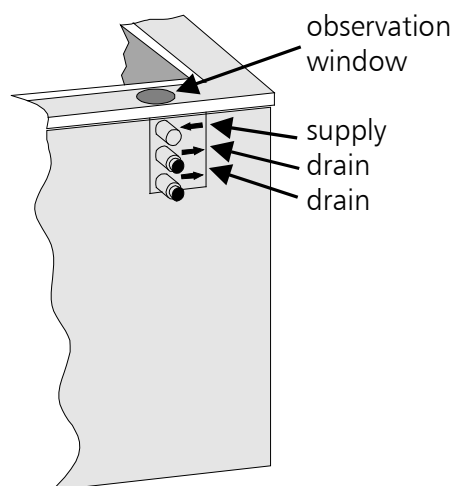

**Warning – bath hot when operating**

## 10 Cooling system (special equipment)

If the waterbath is fitted with a cooling device for quicker cooling of the bath liquid, the "water supply" has to be connected by a hose f.ex. to a cold water supply line. The "discharge" has to be lead into a drain.

(Use temperature resistant material for the tubing)

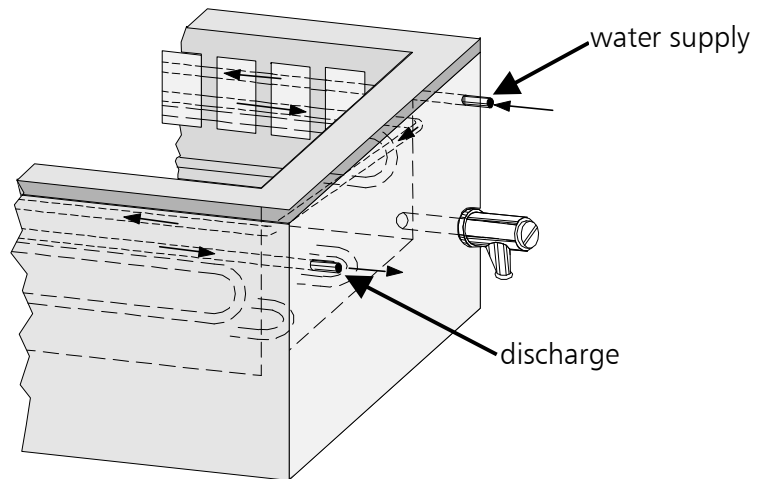

### Please note, that the outflowing water may be hot!

The discharge must be connected with tubing to an appropriate container or sink. Make sure, that the tubing cannot be clogged or bended, and that it continually runs downhill.

## 11 Cleaning and maintenance



By regular cleaning of the easy to clean the tank, residues are avoided which at continuous influence can impair the outfit and function of the waterbath.  
Please use only detergents and antiliming agents appropriate for stainless steel for the cleaning of the tank and the housing (stainless steel detergents usual in the trade)!



After cleaning and after draining the water the stainless steel tank must be rinsed thoroughly with clear water and dried carefully!

It is important to ensure that no rusting objects come into contact with the stainless steel bath tank or the stainless steel housing. Rust sediments lead to contamination.

If rust stains caused by contamination occur on the tank surface, the affected areas must be cleaned and polished immediately.

On units with gable cover we recommend that the hinge bolts are oiled from time to time if the bath is used frequently.

## 12 Check list for fault rectification

Main switch ON, no indication on the display	Main fuse 15A or instrument fuse T80mA 250V~ on circuit board 55167.x has blown Controller faulty Electrical supply interrupted
☹ symbol not alight	Ambient temperature too high Temperature in bath above the selected setpoint temperature
⚠ symbol alight	Temperature protection (TB) has operated Liquid level too low
⚠ symbol flashes	Monitoring relay has operated
CONF	Error on self test
E - 1	Power module triac faulty
E - 2	Power module faulty
E - 3	Pt100-temperature probe faulty
E - 4	Communication to power unit interrupted

In case of a malfunction contact an authorized service station for Memmert equipment or please inform the Memmert service department (see section 16).

In case of queries always specify model and serial number (on the rating label).

## 13 Action on supply failure

After a failure of the supply, operation continues with the previously set parameters.

## 14 Glossary

- nominal temperature = the maximum adjustable setpoint temperature of the bath.
- ambient temperature = the continuous temperature of the room in which the bath is set up.





## EC Declaration of Conformity

Manufacturer's name and address: MEMMERT GmbH + Co. KG  
Äußere Rittersbacher Straße 38  
D-91126 Schwabach

Product: Waterbath  
Type: WNB...  
Sizes: 7 / 10 / 14 / 22 / 29 / 45  
Nominal voltage: AC 230 V 50/60 Hz  
alternative AC 115 V 50/60 Hz

---

The designated product is in conformity with the European EMC-Directive

**2004/108/EEC**  
*including amendments*

**Council Directive of 03 May 1989 on the approximation of the laws of the Member States relating to electromagnetic compatibility.**

*Full compliance with the standards listed below proves the conformity of the designated product with the essential protection requirements of the above-mentioned EC Directive:*

DIN EN 61326:2004-05

EN 61326:1997  
EN 61326/A1:1998  
EN 61326/A2:2001  
EN 61326/A2:2003

---

The designated product is in conformity with the European Low Voltage Directive

**2006/95/EEC**  
*including amendments*

**Council Directive on the approximation of the laws of the Member States relating to Electrical equipment for use within certain voltage limits.**

*Full compliance with the standards listed below proves the conformity of the designated product with the essential protection requirements of the above-mentioned EC Directive:*

DIN EN 61 010-1 (VDE 0411 part 1):2002-08  
DIN EN 61 010-2-010 (VDE 0411 part 2-010):2004-06

EN 61 010-1:2001  
EN 61 010-2-010:2003

---

Schwabach, 03.07.08

(Legally binding signature of the issuer)

**This declaration certifies compliance with the above mentioned directives but does not include a property assurance. The safety note given in the product documentation which are part of the supply, must be observed.**

Standard units are safety-approved and bear the test marks:

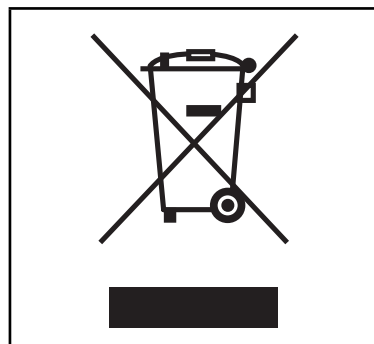

This product is subject to the Directive 2002/96/EC by the European Parliament and the EU Council of Ministers which concerns Waste Electrical and Electronic Equipment (WEEE). This product has been put on the market after 13 August 2005 in countries which have already incorporated this Directive into National Law. It should not be disposed off as part of domestic refuse. For disposal please contact your dealer or the manufacturer. Products which are infected, infectious or contaminated with health-endangering substances are excluded from return. Please note also all further regulations in this context.

### 16 Address and customer service

MEMMERT GmbH+Co.KG  
PO Box 17 20  
91107 Schwabach  
Germany  
Phone: 00 49 9122 / 925-0  
Fax: 00 49 9122 /14585  
E-mail: [sales@memmert.com](mailto:sales@memmert.com)  
Internet: [www.memmert.com](http://www.memmert.com)



Customer service:  
Phone: 00 49 9122 / 925-143  
or 00 49 9122 / 925-126  
E-mail: [service@memmert.com](mailto:service@memmert.com)

In case of queries always specify model and serial number (on the rating label).

© by MEMMERT GmbH+Co.KG

## 17 Index

### A

address 18  
alarm symbol 13  
ambient conditions 4  
ambient temperature 16  
autodiagnostic system 5, 16

### B

bath construction 8  
boiling mode 4  
boiling mode, activate 10  
brief technical description 5

### C

CCC 10  
CE conformity of declaration 17  
check list for fault rectification 16  
chemical compatibility 5  
cleaning 15  
contaminations 7, 15  
controls 8  
cooling system 15  
cover, flat 14  
cover, gable 14  
customer service 18

### D

deionised water 7  
delayed switch-on 10  
DIN 12880 13  
disposal 18  
draining 7  
drain hose 14, 15  
drain valve 7

### E

electrical equipment 5  
electromagnetic compatibility 5  
evaporation loss 14

### F

fault rectification 16  
filling 7

### G

glossary 16

### H

heating 8  
hinge bolts 15  
hold time of the setpoint temperature 11

### I

indications 8  
initial start-up 7  
installation 6

### L

level control system 7, 14  
liquid level 7  
low-level protection 13

### M

maintenance 15  
Mat.Ref. 1.4301 5  
material quality 5  
monitoring the programme sequence 12  
monitor relay 13  
monitor unit 13

### N

nominal temperature 4, 16

### P

parameter settings 9  
polluted fluids 7  
programming example 11  
Protection Class 1 13  
Pt 100 temperature sensor 5

### R

rust deposits 15

### S

safety notes 3  
setpoint temperature 16  
setpoint temperature, selection 10  
standard equipment 6  
start-up 7  
supply failure 16  
switching on the bath 9

### T

TB 13  
technical data 4  
temperature fluctuation 5  
temperature limiter (TB) 13  
temperature measurement 5  
temperature monitor 13  
thermofluid 7  
transport 3

### U

uniform temperature distribution 8

### W

water circulation 8  
working temperature range 4

