



Thermo Scientific SL Plus Series Centrifuges

Instructions for Use

50158558-f • 07 / 2021

Table of Contents

Preface

About this Manual	vii
Where Do I Find Information about my Centrifuge?	vii
Intended Use	vii
Signal Words and Symbols	viii
Symbols used on Unit and Accessories	viii
Symbols used in the Instructions for Use	ix
Safety Instructions	x

1. Transport and Set Up

1. 1. Unpacking	1-1
1. 2. Location	1-1
1. 3. Transporting	1-2
1. 4. Product Overview	1-7
1. 5. Connections	1-10
1. 6. Initial Startup	1-10

2. Operation

2. 1. Position of parts	2-1
2. 2. Power on/off the Centrifuge	2-4
2. 3. Open/Close the Centrifuge Lid	2-4
2. 4. How to Install and Remove a Rotor	2-5
2. 5. Load the Rotor	2-7

2. 6. Identify Rotor and Buckets	2-10
2. 7. Set Basic Centrifugation Parameters	2-11
2. 8. Pre-Temper the Centrifugation Chamber	2-11
2. 9. Centrifugation	2-12
2. 10. Aerosol-Tight Applications	2-13

3. LCD Control Panel

3. 1. Overview	3-1
3. 2. Set Basic Centrifugation Parameters	3-2
3. 3. Programs	3-6
3. 4. Centrifugation	3-6
3. 5. Stop an Ongoing Centrifugation Run	3-7
3. 6. System Menu	3-8

4. Maintenance and Care

4. 1. Cleaning Intervals	4-1
4. 2. Basics	4-1
4. 3. Cleaning	4-2
4. 4. Disinfection	4-4
4. 5. Decontamination	4-4
4. 6. Autoclaving	4-5
4. 7. Maintenance	4-5
4. 8. Shipping	4-6
4. 9. Storage	4-6
4. 10. Disposal	4-6

5. Troubleshooting

5. 1. Mechanical Emergency Door Release	5-1
5. 2. Ice Formation	5-2
5. 3. Troubleshooting by Guide	5-2
5. 4. Information for the Customer Service	5-3

A. Technical Specifications

B. Rotor Specifications

C. Chemical Compatibility

List of Figures

Figure 1–1: Safety Zone	1-2
Figure 1–2: Lifting the Tabletop Centrifuge at Both Sides	1-2
Figure 1–3: Space Required for Unloading	1-3
Figure 1–4: Removing the Outer Strapping and Packaging	1-3
Figure 1–5: Removing the Inner Strapping and Cardboard Protectors	1-4
Figure 1–6: Removing the Stops from the Pallet	1-4
Figure 1–7: Mounting the Rails for Unloading	1-5
Figure 1–8: Rolling the Centrifuge off the Pallet	1-5
Figure 1–9: Locking the Centrifuge Castors	1-6
Figure 1–10: Product overview – refrigerated 1 L benchtop centrifuge with LCD control panel	1-7
Figure 1–11: Product overview – ventilated 1 L benchtop centrifuge with LCD control panel	1-7
Figure 1–12: Product overview – refrigerated 4 L benchtop centrifuge with LCD control panel	1-8
Figure 1–13: Product overview – ventilated 4 L benchtop centrifuge with LCD control panel	1-8
Figure 1–14: Product overview – refrigerated 4 L floorstanding centrifuge with LCD control panel	1-9
Figure 1–15: Product overview – ventilated 4 L floorstanding centrifuge with LCD control panel	1-9
Figure 2–1: Position of centrifuge parts shown on a ventilated centrifuge with LCD control panel	2-1
Figure 2–2: Position of rotor parts shown on a fixed angle rotor	2-1
Figure 2–3: Position of the slot in the bucket and the corresponding adapter key	2-2
Figure 2–4: Position of rotor parts shown on a swinging bucket rotor	2-2
Figure 2–5: Position of rotor parts shown on a windshielded swinging bucket rotor	2-3
Figure 2–6: Rear view of benchtop centrifuge, position of the mains switch	2-4
Figure 2–7: Rear view of floorstand centrifuge, position of the mains switch	2-4
Figure 2–8: Put on/off the rotor lid	2-5
Figure 2–9: Turn the rotor knob	2-6
Figure 2–10: Pressing the Auto-Lock key	2-6
Figure 2–11: Auto-Lock on the drive shaft	2-7
Figure 2–12: Slot and Key on Paired Buckets and Rotors	2-7
Figure 2–13: Correct loading examples for fixed angle rotors	2-8
Figure 2–14: Correct loading examples for swinging bucket rotors	2-8
Figure 2–15: Incorrect loading examples for fixed angle rotors	2-8
Figure 2–16: Incorrect loading examples for swinging bucket rotors	2-8
Figure 2–17: Rotor Detection: Choosing a Bucket Type for a TX-750 Rotor	2-10
Figure 2–18: Setting the Correct Bucket Code	2-11
Figure 2–19: Lid of an aerosol-tight rotor with mandrel	2-13
Figure 2–20: Bucket with open lid (left) and closed lid (right)	2-14
Figure 3–1: Functions on the LCD Control Panel	3-1
Figure 3–2: Choosing between RCF / rpm and setting the Centrifuge Speed	3-2
Figure 3–3: Setting the Centrifuge Run Time	3-3
Figure 3–4: Setting the Acceleration Profile	3-3
Figure 3–5: Setting the Deceleration Profile	3-4
Figure 3–6: Setting the Pre-cooling or Pre-warming Temperature (left)	3-4
Figure 3–7: Setting the Temperature for the Centrifugation Run (right)	3-5
Figure 3–8: Setting the Correct Bucket Code for the Rotor	3-5
Figure 4–1: Removing the ventilation grid	4-3
Figure 5–1: Emergency door release on the back side	5-1

List of Tables

Table i: List of Thermo Scientific Centrifuges	viii
Table ii: Signal Words and Symbols	viii
Table iii: Symbols used on Unit and Accessories	ix
Table iv: Symbols used in the Instructions for Use	ix
Table 1-1: Items Supplied	1-1
Table 5-1: Error Messages	5-3
Table A-1: Technical Data SL Plus Series Centrifuges	A-1
Table A-2: Technical Data SL Plus Series Centrifuges	A-2
Table A-3: Technical Data SL Plus Series Centrifuges	A-3
Table A-4: Directives and Standards for SL Plus Series Centrifuges	A-4
Table A-5: Directives and Standards for SL Plus-MD Series Centrifuges	A-5
Table A-6: Refrigerants Used for SL Plus Series	A-6
Table A-7: Electrical Connection Data for SL Plus Series	A-7
Table A-8: Rotor Program - General and IVD Use	A-8

Preface

Before starting to use the centrifuge, read through these instructions for use carefully and follow the instructions. The information contained in these instructions for use is the property of Thermo Fisher Scientific; it is prohibited to copy or pass on this information without explicit approval in writing by its owner.

Failure to follow the instructions and safety information in these instructions for use will result in the expiration of the seller's warranty.

About this Manual

This manual is subdivided into the following chapters:

- **Preface** (this chapter): Contains general introductory information, explains how to identify your centrifuge, spells out the intended use, explains the safety labels, and contains precautions.
- **Transport and Setup**: Contains the list of items supplied, explains how to transport the centrifuge to its intended location, how to connect power and Ethernet cables and how to accomplish the basic set-up.
- **Operation**: Contains instructions for centrifugation, including basic operations like loading and installing the rotor, entering centrifugation parameters, and running the centrifuge.
- **Graphical User Interface**: Explains the touchscreen and its menus.
- **LCD Control Panel**: Explains the LCD display, its front-panel controls and its functions.
- **Maintenance and Care**: Explains how to perform basic care activities like cleaning, disinfection, decontamination of the centrifuge and its rotors, and explains which parts are suitable for autoclaving. Also lists regular maintenance tasks like visual inspection, ventilation grid cleaning, and more specific maintenance tasks for selected rotor types, plus parts to be replaced by Thermo Fisher Scientific authorized service during preventive maintenance. And it contains general advice for storage and shipping.
- **Troubleshooting**: Explains how to use the emergency door release in order to open the centrifuge lid when the device is out of power, how to remove icing from the centrifugation chamber, how to troubleshoot error messages that appear on the display, and how to gather device information before you call Thermo Fisher Scientific service.
- **Technical Specifications**: Lists the technical data for all centrifuge models described in this manual.
- **Rotors**: Contains rotor tables for all centrifuge models described in this manual as well as specifications and accessory information for all compatible rotors.
- **Chemical Compatibility Chart**: Contains a reference chart that indicates how centrifuge and rotor materials respond to attack through frequently-used chemical agents.
- **Index**: Lists keywords in alphabetical order, with pointers to pages where they occur.

Where Do I Find Information about my Centrifuge?

This manual covers multiple Thermo Scientific SL Plus Series centrifuge models.

You can identify your centrifuge model by gathering two items of information:

- the product series from the front panel—for example, Thermo Scientific SL Plus Series
- the product number and product name from the nameplate—for example, “75009912” and “Thermo Scientific SL4 Plus” as shown in “List of Thermo Scientific Centrifuges” on page viii.

Intended Use

Intended Use for Laboratory Use Centrifuges

This centrifuge is designed to separate sample mixtures of different densities like chemicals, environmental samples and other non-human body samples.

Intended Use for IVD Centrifuges

This centrifuge can be used as IVD (In vitro diagnostic) laboratory equipment if used together with IVD tubes and IVD diagnostic analysis systems.

The centrifuge separates human blood. Blood is used in numerous diagnostic tests such as hematological screening (e.g. measurement of free hemoglobin), immunological screening (e.g. measurement of thrombocytes levels), cardio-vascular system assessment (e.g. analysis of potassium level).

Intended User

This centrifuge must be operated by trained personnel only.

Trained personnel can be a clinical laboratory technologist, a medical laboratory technician, or a person with an equivalent education.

Laboratory Use Centrifuges		In Vitro Diagnostic Centrifuges	
Article No.	Benchtop Centrifuge	Article No.	Benchtop Centrifuge
75009600	SL1 Plus 100–240 V \pm 10%, 50 / 60 Hz	75009000	SL1 Plus-MD 100–240 V \pm 10%, 50 / 60 Hz
75009630	SL1R Plus 220–230 V \pm 10%, 50 / 60 Hz	75009030	SL1R Plus-MD 220–230 V \pm 10%, 50 / 60 Hz
		75009031	SL1R Plus-MD 120 V \pm 10%, 60 Hz
75009912	SL4 Plus 208–240 V \pm 10%, 50 / 60 Hz	75009512	SL4 Plus-MD 208–240 V \pm 10%, 50 / 60 Hz
		75009513	SL4 Plus-MD 120 V \pm 10%, 60 Hz
75009927	SL4R Plus 220–240 V \pm 10%, 50 Hz / 230 V \pm 10%, 60 Hz	75009527	SL4R Plus-MD 220–240 V \pm 10%, 50 Hz / 230 V \pm 10%, 60 Hz
75009827	SL4R Plus 220 V \pm 10%, 60 Hz	75009627	SL4R Plus-MD 220 V \pm 10%, 60 Hz
		75009528	SL4R Plus-MD 120 V \pm 10%, 60 Hz
75009951	SL4F Plus 208–240 V \pm 10%, 50 / 60 Hz	75009971	SL4F Plus-MD 208–240 V \pm 10%, 50 / 60 Hz
75009953	SL4RF Plus 220–240 V \pm 10%, 50 Hz / 230 V \pm 10%, 60 Hz	75009973	SL4RF Plus-MD 220–240 V \pm 10%, 50 Hz / 230 V \pm 10%, 60 Hz

Table i: List of Thermo Scientific Centrifuges

Signal Words and Symbols

Signal Word and Colors	Degree of Hazard
WARNING	Indicates a hazardous situation that, if not avoided, could result in death or serious injury.
CAUTION	Indicates a hazardous situation that, if not avoided, could result in minor or moderate injury.
NOTICE	Indicates information considered important, but not hazard-related.

Table ii: Signal Words and Symbols

Symbols used on Unit and Accessories

Observe the information contained in the instructions for use to keep yourself and your environment safe.









	General hazard		Refer to instruction manual
	Biological hazard		Disconnect mains plug
	Danger of cuts		Direction of rotation
	Reminds you to ensure that the rotor is installed properly by lifting it slightly at the handle.		Floorstanding centrifuges: Cautions you to lock the castors before starting the centrifuge.

Table iii: Symbols used on Unit and Accessories

Symbols used in the Instructions for Use

Observe the information contained in the instructions for use to keep yourself and your environment safe.









	General hazard		Electrical hazard
	Biological hazard		Danger of cuts
	Hazard caused by flammable materials		Indicates information considered important, but not hazard-related.
	Risk of crushing		Wear protective gloves
	Wear protective goggles		

Table iv: Symbols used in the Instructions for Use

Safety Instructions



WARNING

Not following these safety instructions can lead to hazardous situations that, if not avoided, could result in death or serious injury.

Observe the safety instructions.

The centrifuge is to be used for its intended use only. Improper use can cause damages, contamination, and injuries with fatal consequences.

The centrifuge must be operated by trained personnel only.

It is the obligation of the operator to make sure that the proper protective clothing is used. Mind the "Laboratory Biosafety Manual" of the World Health Organization (WHO) and the regulations in your country.

Keep a safety zone of minimum 30 cm around the centrifuge. Refer to "Figure 1-1: Safety Zone". Persons and hazardous substances must be kept out of this safety zone while centrifuging.

Do not modify the centrifuge and its accessories in any unauthorized way.

Do not operate a centrifuge if its housing is open or incomplete.



WARNING

Risk of damage due to incorrect power supply.

Make sure that the centrifuge is plugged only into a power outlet that has been properly grounded.



WARNING

Risk from handling hazardous substances.

When working with corrosive samples (salt solutions, acids, bases), the accessories and the centrifuge have to be cleaned thoroughly.

Extreme care should be taken with highly corrosive substances that can cause damage and impair the mechanical stability of the rotor. These should only be centrifuged in fully sealed tubes.

The centrifuge is neither inert nor protected against explosion. Never use the centrifuge in an explosion-prone environment.

Do not centrifuge toxic or radioactive materials or any pathogenic micro-organisms without suitable safety precautions.

When centrifuging any hazardous materials mind the "Laboratory Biosafety Manual" of the World Health Organization (WHO) and any local regulations. When centrifuging microbiological samples from the Risk Group II (according to the "Laboratory Biosafety Manual" of the World Health Organization (WHO)), aerosol-tight biological seals have to be used. Visit the internet page of the World Health Organization (www.who.int) for the "Laboratory Biosafety Manual". For materials in a higher risk group, extra safety measures must be taken.

If toxins or pathogenic substances have contaminated the centrifuge or its parts, appropriate disinfection measures have to be taken ("Disinfection" on page 4-4).

If a hazardous situation occurs, turn off the power supply to the centrifuge and leave the area immediately.

Make sure to use the proper accessories for your applications to avoid hazardous contamination.

In any case of severe mechanical failure, such as rotor or bottle crash, personnel should be aware that the centrifuge is not aerosol-tight. Leave the room immediately. Contact the customer service. Aerosols need time to settle before opening the centrifuge after a crash. Ventilated centrifuges bear a higher risk of being contaminated after a crash than refrigerated centrifuges.



WARNING

Risk of contamination.

Potential contaminations will not remain in the centrifuge while the device is operated.

Take appropriate protection measures to prevent spread of contaminations.

A centrifuge is no closed containment.



Damage to health from centrifuging explosive or flammable materials or substances.

Do not centrifuge explosive or flammable materials or substances.

WARNING



Serious injuries can occur if you touch a spinning rotor with your hands or tools.

A rotor can still be spinning after a power failure occurs.

WARNING

Do not open the centrifuge before the rotor has stopped spinning. Do not touch a spinning rotor. Open the centrifuge only if the rotor has stopped spinning.

Never use your hands or tools to stop a spinning rotor.

The emergency door release may be used in emergencies only to recover the samples from the centrifuge, for example, during a power failure (“Mechanical Emergency Door Release” on page 5-1).



The magnets built into the rotors can have a negative effect on active implants, such as cardiac pacemakers.

WARNING

The magnets are mounted on the bottom of the rotor.

Always keep a distance of 20 cm between the rotor and the active implant, as the product generates permanent magnetic fields. The magnetic field strength at a distance of 20 cm is less than 0.1 mT, so there should be no interference.



Risk of injuries from defective gas spring

Make sure that the centrifuge lid can be opened completely and that it will stay in its position.

CAUTION

Regularly check gas springs for their proper function.

Let an authorized service technician replace defective gas springs.



Cutting injuries from broken display glass.

Do not touch a damaged display.

CAUTION



Safety can be impaired by wrong loading and worn accessories.

Always make sure that the load is as equally distributed as possible.

CAUTION

Do not use rotors and accessories which show any signs of corrosion or cracks. Contact customer service for further information.

Do not operate the centrifuge with an unbalanced rotor. Use only rotors which have been loaded properly.

Never overload the rotor.

Make sure that rotors and accessories are installed properly before operating the centrifuge. Follow the instructions in section “How to Install and Remove a Rotor” on page 2-5.



Physical harm caused by ignoring operative basics.

Operate the centrifuge with a properly installed rotor.

CAUTION

Do not move the centrifuge while it is running.

Do not lean on the centrifuge.

Do not put anything on the centrifuge while it is running.

The centrifuge housing is not to be opened by the operator.



Risk of accident while moving floorstanding centrifuge

Assign at least two persons as handlers for moving a floorstanding centrifuge model. Instruct the handlers to push the centrifuge from both sides and stay out of the path of the moving centrifuge at all times.

CAUTION

**CAUTION****Due to air friction sample integrity may be affected.**

The temperature of the rotor may rise significantly while the centrifuge is spinning.

Ventilated units lead to a heat up of the rotor above the ambient temperature.

Refrigerated units can have a deviation from displayed and set temperature to the sample temperature.

Make sure the centrifuge temperature control capabilities meet your application specification. If necessary make a test run.

**NOTICE****Protection capability may be impaired due to using unapproved accessories.**

Use only accessories for this centrifuge which have been approved by Thermo Fisher Scientific. For a list of approved accessories refer to "Rotor Specifications" on page B-1.

Exceptions to this rule are commercially available glass or plastic centrifuge labware, provided they have been designed to fit in the rotor or the adapter cavities and are approved for the speed or the RCF value of the rotor.

**NOTICE****Damage to device or malfunction due to a damaged touch screen.**

Do not operate the device.

Power off the centrifuge. Disconnect the mains plug. Let an authorized service technician replace the touchscreen.

**NOTICE****To shut down the centrifuge:**

Press the "Stop" key. Turn off the centrifuge at the main switch. Pull out the power supply plug. In an emergency disconnect the power supply.

Make sure that the main switch and power supply plug can be accessed easily when setting up the centrifuge. The grounded electrical socket should be well accessible and located outside of the safety zone.

**NOTICE**

Working with the user interface of a floor-standing centrifuge is not ergonomic over the long term.

We recommend to use a seat if you are working on the user interface for long periods.

1. Transport and Set Up

NOTICE

It is your responsibility to ensure that all requirements are met for safety reasons.

1.1. Unpacking

The shipping carton should be inspected upon delivery. When received, carefully examine for any shipping damage before unpacking. If damage is discovered, the delivering carrier should specify and sign for the damage on your copy of the delivery receipt.

Open the carton carefully making certain that all parts (Table 1–1) are accounted for before packaging materials are discarded. Remove the packaging completely. After unpacking, if damage is found, report it to the carrier and request a damage inspection. Dispose of the packaging in accordance with local waste disposal regulations.

Failure to request an inspection of damage within a few days after receipt of shipment absolves the carrier from any liability for damage. You must call for a damage inspection.

Items Supplied

Please note that the centrifuge is supplied without a rotor. Rotors and items supplied with rotors are listed in the chapter “Rotor Specifications” on page B-1.

Item	Art. No.	Quantity
Thermo Scientific Centrifuge		1
Power Supply Cable		1
Printed Instructions for Use	50158558	1
Instructions for Use on USB	50158587	1
Anti-corrosion oil	70009824	1

Table 1–1: Items Supplied

If any parts are missing, please contact the nearest Thermo Fisher Scientific representative.

1.2. Location

Operate the centrifuge only indoors.

The set up location must meet these requirements:

- Keep a safety zone of minimum 30 cm around the centrifuge. Refer to “Safety Zone” on page 1-2.

Persons and hazardous substances must be kept out of this safety zone while centrifuging.

Centrifuges cause vibrations. Do not store sensitive devices or dangerous objects or substances in the safety zone.

⚠ WARNING Risk of impact. The centrifuge can crush objects and persons in a radius of 30 cm while spinning. Keep a safety zone of 30 cm around the centrifuge for safe operation. Make sure that no one is in the safety zone while the centrifuge is spinning.

- The supporting structure must meet these requirements:

- » Be stable, solid, rigid and free of resonance.
- » Be applicable for horizontal set up of the centrifuge.

It is not allowed to put anything under the centrifuge to compensate for an uneven surface.

Do not operate the centrifuge on carts or stand-alone shelving that could move during operation or is inadequately sized for the centrifuge.

- » Be able to hold the weight of the centrifuge.

- The centrifuge is not equipped with any means for leveling. The supporting structure must be suitably level to allow proper set up.

⚠ CAUTION If you do not level the centrifuge, the centrifuge can crash because of imbalance. If you move the centrifuge, you must level it again. Do not move the centrifuge with a rotor attached to the drive shaft because damage can occur to the drive. Do not put anything below the centrifuge feet to level the centrifuge.

- Do not expose the centrifuge, accessories and samples to heat and strong sunlight.

⚠ CAUTION UV rays reduce the stability of plastics. Do not subject the centrifuge, rotors and plastic accessories to direct sunlight.

- The set up location must be well ventilated at all times.
- The main switch and power supply plug must be easily accessible at all times. The grounded electrical socket should be well accessible and located outside of the safety zone.

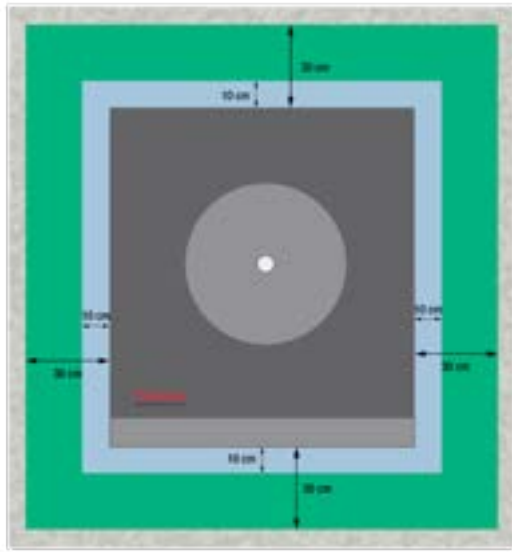

Figure 1-1: Safety Zone

1.3. Transporting

Before transporting a centrifuge make sure that

- the power supply cable is unplugged and removed from the centrifuge.
- the rotor is removed.
 - ⚠ **CAUTION** Damage to centrifuge or drive shaft due to movement of an installed rotor. Always remove the rotor before you transport the centrifuge.
- the centrifuge door is closed.
 - ⚠ **CAUTION** Hands can be squeezed by an open centrifuge door. Always close the centrifuge door before you transport the centrifuge.

Before transporting a rotor make sure that

- all components, like adapters and buckets are removed to prevent dropping damage.

1.3.1. Handling Benchtop Centrifuges

When handling a benchtop centrifuge make sure that

- the centrifuge is lifted at both sides and not at the front or back.

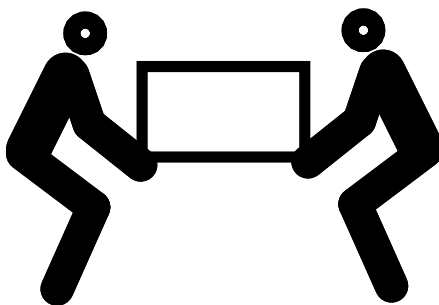

Figure 1-2: Lifting the Tabletop Centrifuge at Both Sides

⚠ **WARNING** Always lift the centrifuge on both sides. Never lift the centrifuge by its front or back. The centrifuge is heavy (see “Technical Specifications” on page A-1). Assign a minimum of 4 persons to lift and carry a refrigerated centrifuge. Assign a minimum of 2 persons to lift and carry a ventilated centrifuge.

1. 3. 2. Handling and Unpacking a Floorstanding Centrifuge

Floorstanding centrifuges come strapped to a custom-made shipping pallet. The pallet has angular stops on all four corners to prevent the centrifuge from rolling off. Supplied with each pallet is a pair of rails that serve as ramps for rolling off the centrifuge to level ground.

When moving a floorstanding centrifuge make sure that

- for long-haul transport, the centrifuge must be mounted on its original shipping pallet.
- for relocation on the premises, the castors and brakes of the centrifuge are fully functional.

⚠ CAUTION The centrifuge is heavy (see “Technical Specifications” on page A-1). Do not try to lift the centrifuge manually. To move the centrifuge using a forklift truck, strap it to its original shipping pallet. Never lift the centrifuge without the original shipping pallet.

⚠ WARNING Assign a minimum of 2 persons for moving the centrifuge. Instruct the handlers to push the centrifuge from both sides and stay out of the path of the moving centrifuge. A runaway centrifuge may crush a person in its path and inflict serious or lethal injury.

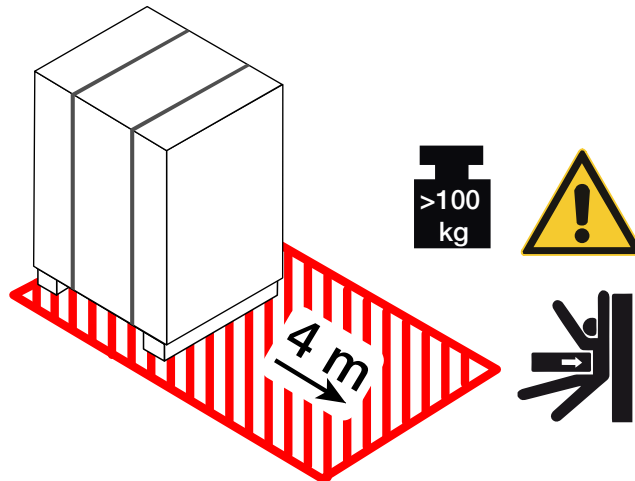

Figure 1-3: Space Required for Unloading

1. Place the pallet with the centrifuge so that you have at least 4 m of space in front of the pallet, as indicated by the cross-hatched area in Figure 1-3.

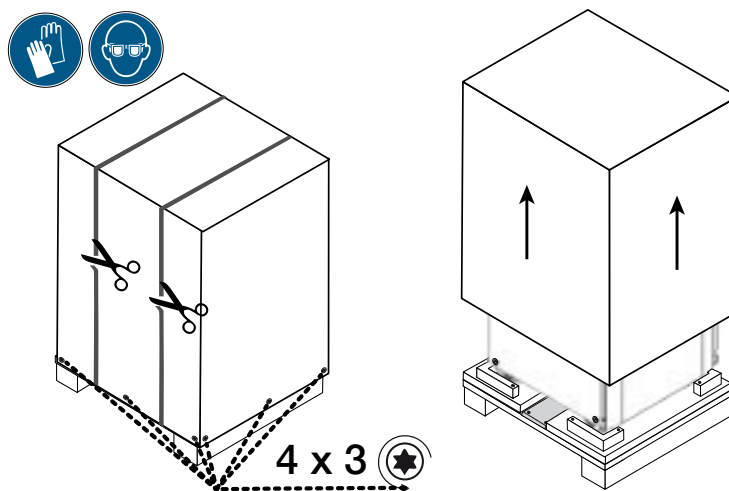

Figure 1-4: Removing the Outer Strapping and Packaging

2. Using a pair of scissors, cut and remove the outer strapping around the shipping package, as shown on the left side in Figure 1-4.
3. Using a screwdriver, remove the woodscrews (four times three pieces, as indicated in Figure 1-4 from the bottom of the cardboard box or wooden crate outer packaging).
4. Lift off the cardboard box or wooden crate, as shown on the right side in Figure 1-4.

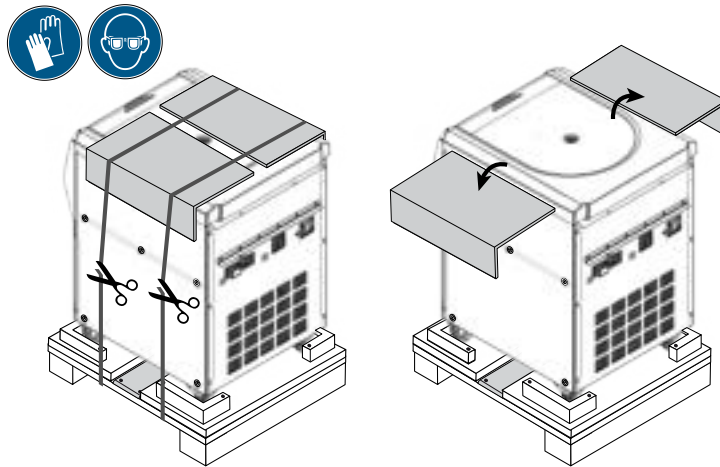

Figure 1-5: Removing the Inner Strapping and Cardboard Protectors

5. Using a pair of scissors, cut and remove the second set of straps securing the centrifuge to the pallet, as shown on the left side in Figure 1-5.
6. Remove the two cardboard protectors from the top of the centrifuge, as shown on the right side in Figure 1-5.
7. Remove the shrinkwrap foil wrapped around the centrifuge.

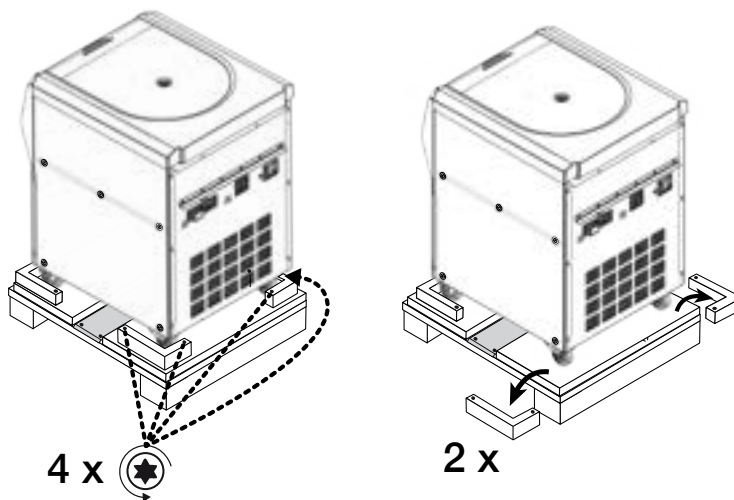

Figure 1-6: Removing the Stops from the Pallet

8. Using a screwdriver, unscrew the woodscrews (two times two pieces, as indicated on the left side of Figure 1-6) from the angular stops on the rear corners of the pallet.
9. Remove the two rear stops from the pallet, as shown on the right side in Figure 1-6.

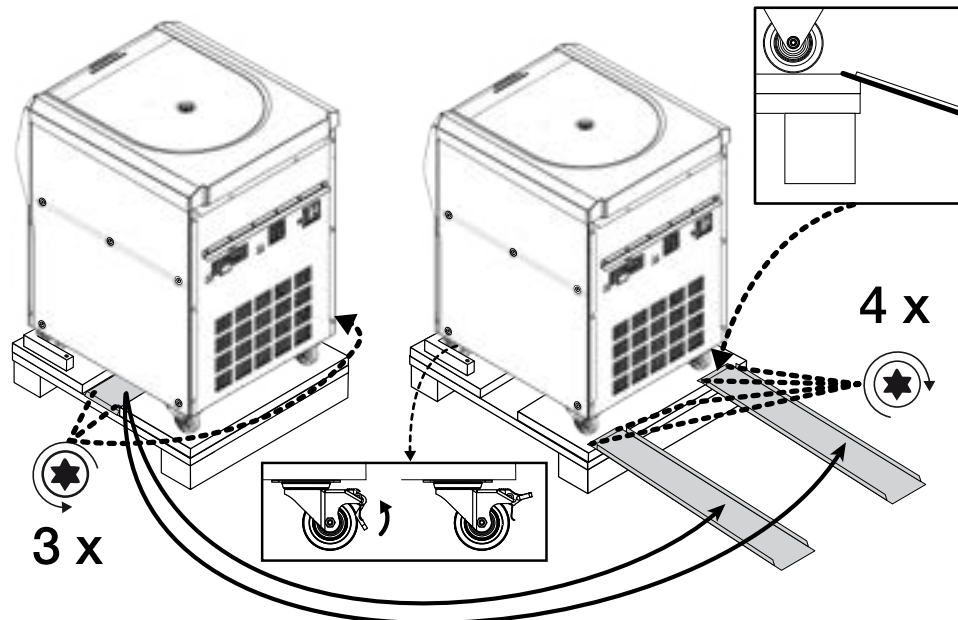

Figure 1-7: Mounting the Rails for Unloading

10. Locate the rails in the middle of the pallet underneath the centrifuge, as shown on the left side in Figure 1-7.
11. Using a screwdriver, remove the three woodscrews that secure the rails to the pallet. There are two screws on one side and a third screw on the opposite side of the rail that need to be removed.
12. Remove the rails from underneath the centrifuge and place one just before each of the two front castors, as shown on the right side in Figure 1-7.
13. Make sure the rails are correctly positioned:
 - a. The rails must be placed centered on the castors, so the castor wheels run exactly in the middle of each rail.
 - a. The pallet has a beveled edge. The end of the tab must rest on the beveled edge and be completely flush with the top surface of the pallet, as shown in the square box in the upper right corner of Figure 1-7.
14. Using two of the leftover woodscrews, fasten each rail to the pallet, as shown on the right side in Figure 1-7.

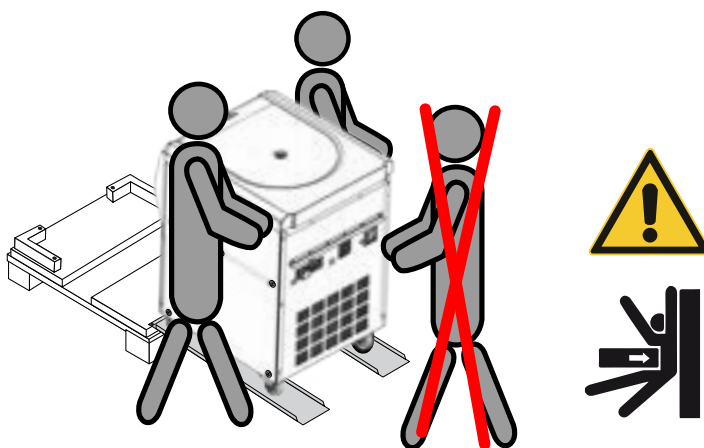

Figure 1-8: Rolling the Centrifuge off the Pallet

15. Place one person on each side of the centrifuge, as shown in Figure 1-8.

⚠ **CAUTION** Do not allow any persons in the path of the moving centrifuge. A runaway centrifuge may crush a person in its path and inflict serious injury.
16. Unlock the swiveling castors on the front side of the centrifuge by flipping up their locking levers, as shown in the rectangular box at the bottom center of Figure 1-7.
17. Have both persons grasp the rear corners of the centrifuge, so they can control the speed of the unit as it rolls down the ramp.

18. Push the centrifuge off the pallet and run it slowly down the rails, carefully controlling the speed until it reaches level ground.
19. Once the centrifuge has reached its intended location, lock the swiveling castors on the front side of the centrifuge to immobilize the centrifuge.

NOTICE

The swiveling castors can be identified by their brake levers. If you do not see the brake levers, turn the castors by 180 degrees so they stick out from under the front side of the centrifuge.

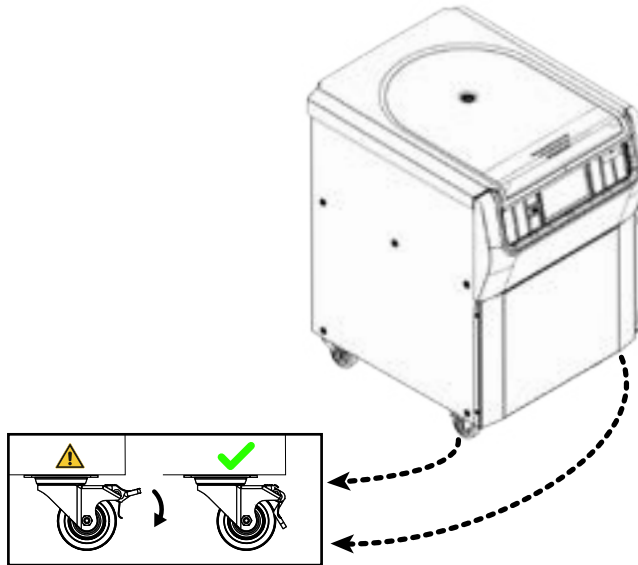

Figure 1-9: Locking the Centrifuge Castors

20. To lock the castors, step on the lever that sticks out from underneath the front side of the centrifuge, as shown in Figure 1-9.

1. 4. Product Overview

This chapter describes the locations of signal and power connectors, and the main power switch.

1. 4. 1. 1 L Refrigerated Benchtop Centrifuges

With LCD Control Panel

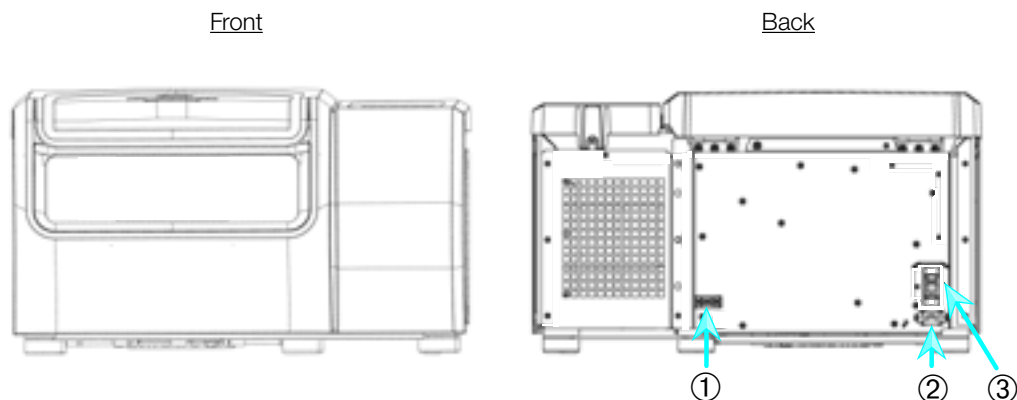

① RS232; ② Mains Connection; ③ Power Supply Switch

Figure 1-10: Product overview — refrigerated 1 L benchtop centrifuge with LCD control panel

1. 4. 2. 1 L Ventilated Benchtop Centrifuges

With LCD Control Panel

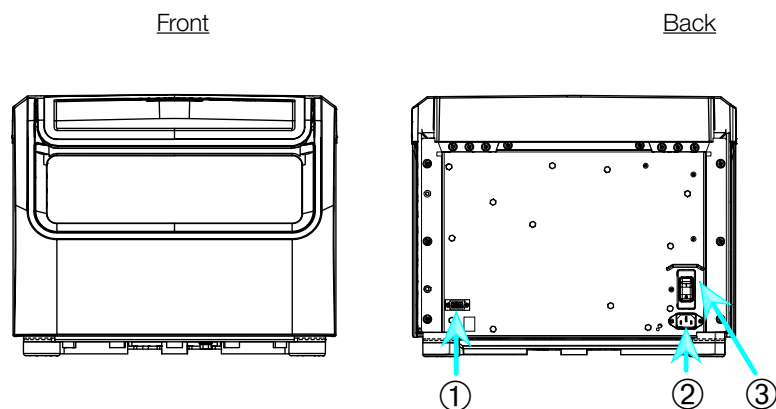

① RS232; ② Mains Connection; ③ Power Supply Switch

Figure 1-11: Product overview — ventilated 1 L benchtop centrifuge with LCD control panel

1. 4. 3. 4 L Refrigerated Benchtop Centrifuges

With LCD Control Panel

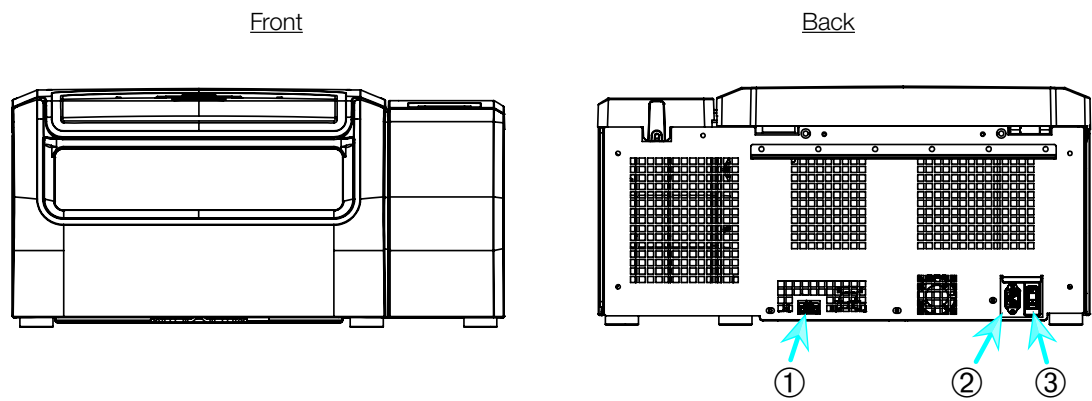

① RS232; ② Mains Connection; ③ Power Supply Switch

Figure 1-12: Product overview — refrigerated 4 L benchtop centrifuge with LCD control panel

1. 4. 4. 4 L Ventilated Benchtop Centrifuges

With LCD Control Panel

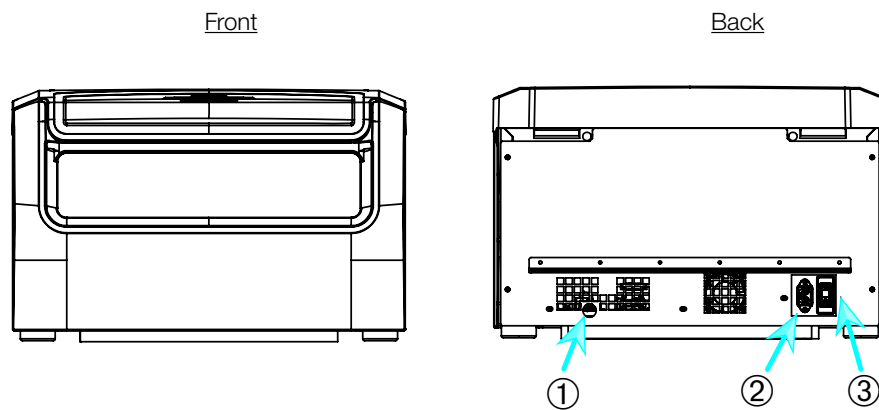

① RS232; ② Mains Connection; ③ Power Supply Switch

Figure 1-13: Product overview — ventilated 4 L benchtop centrifuge with LCD control panel

1. 4. 5. 4 L Refrigerated Floorstanding Centrifuges

With LCD Control Panel

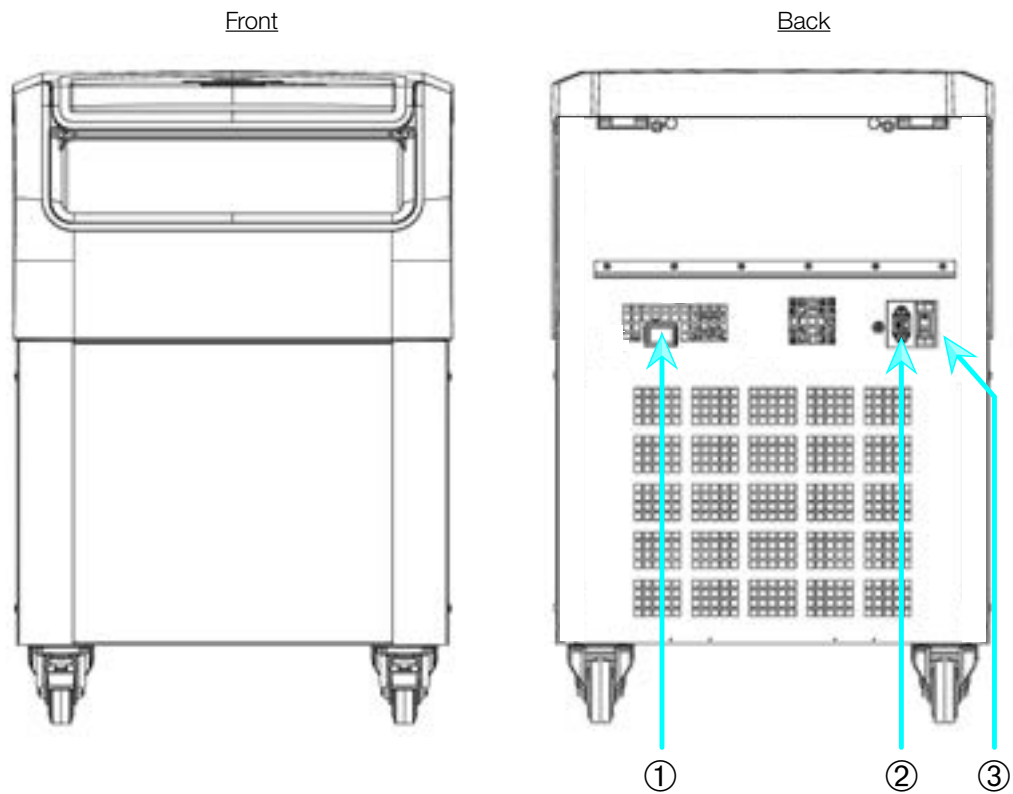

① RS232; ② Mains Connection; ③ Power Supply Switch

Figure 1-14: Product overview — refrigerated 4 L floorstanding centrifuge with LCD control panel

1. 4. 6. 4 L Ventilated Floorstanding Centrifuges

With LCD Control Panel

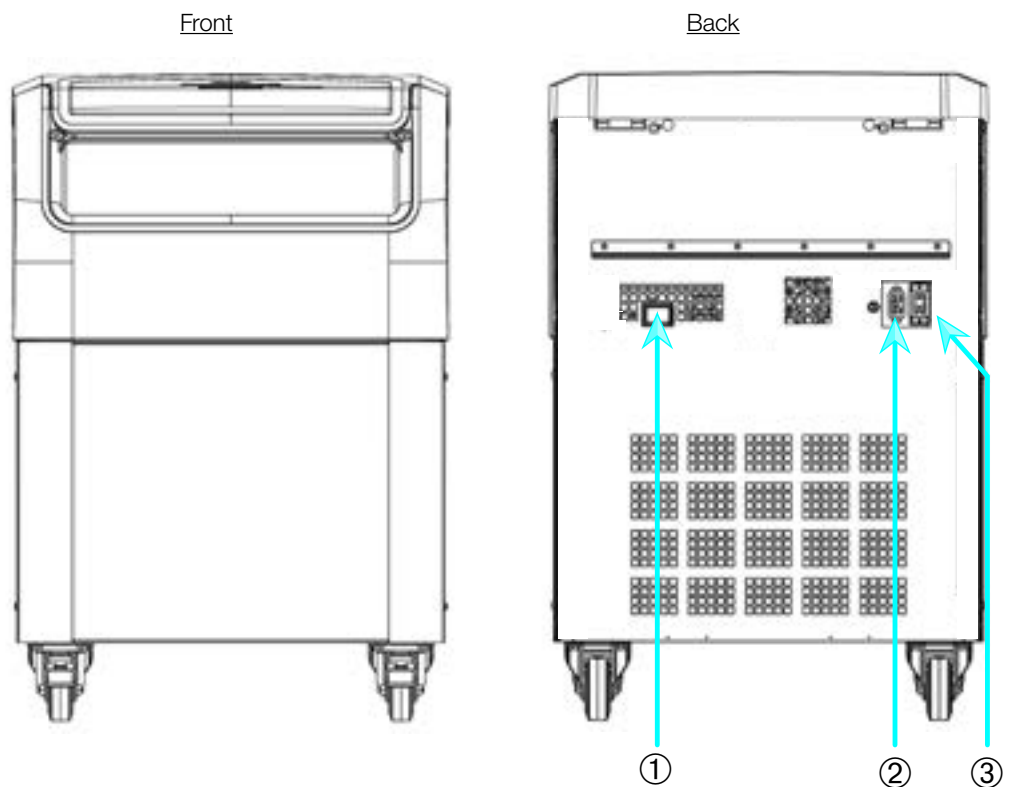

① RS232; ② Mains Connection; ③ Power Supply Switch

Figure 1-15: Product overview — ventilated 4 L floorstanding centrifuge with LCD control panel

1.5. Connections

1.5.1. Mains Connection

NOTICE

Connect the centrifuge into grounded electrical sockets only.

1. Turn off the Power Supply Switch.
2. Make sure that the power supply cable specification agrees with the safety standards of your country.
3. Make sure that the voltage and frequency are the same as the figures on the nameplate.
4. Make sure that the power supply cable is plugged in properly.

1.5.2. RS232

The centrifuge has a RS232 interface, which can be used to connect to a terminal device.

1.5.3. Ethernet

Some centrifuge models have a RJ45 ethernet interface, which can be used to connect to a Local Area Network (LAN). Use only equipment conforming to the IEC 60950-1 standard with the RJ45 ethernet interface.

1.5.4. USB

Some centrifuge models have an USB-A 2.0 port, which can be used with an USB drive. Use only equipment conforming to the USB 2.0 standard with the USB connection.

1.6. Initial Startup

Centrifuges with a graphical user interface (GUI)

In the initial startup sequence you must make some first settings:

- Language
- Unit Name
- City and Country
- Date Format
- Current Date

Complete these steps before using the unit. These settings can be changed again later.

Centrifuges with a LCD control panel

LCD control panel centrifuges are factory setup using English as preset language. Settings can be changed later. Refer to "System Menu" on page 3-8.

2. Operation

2. 1. Position of parts

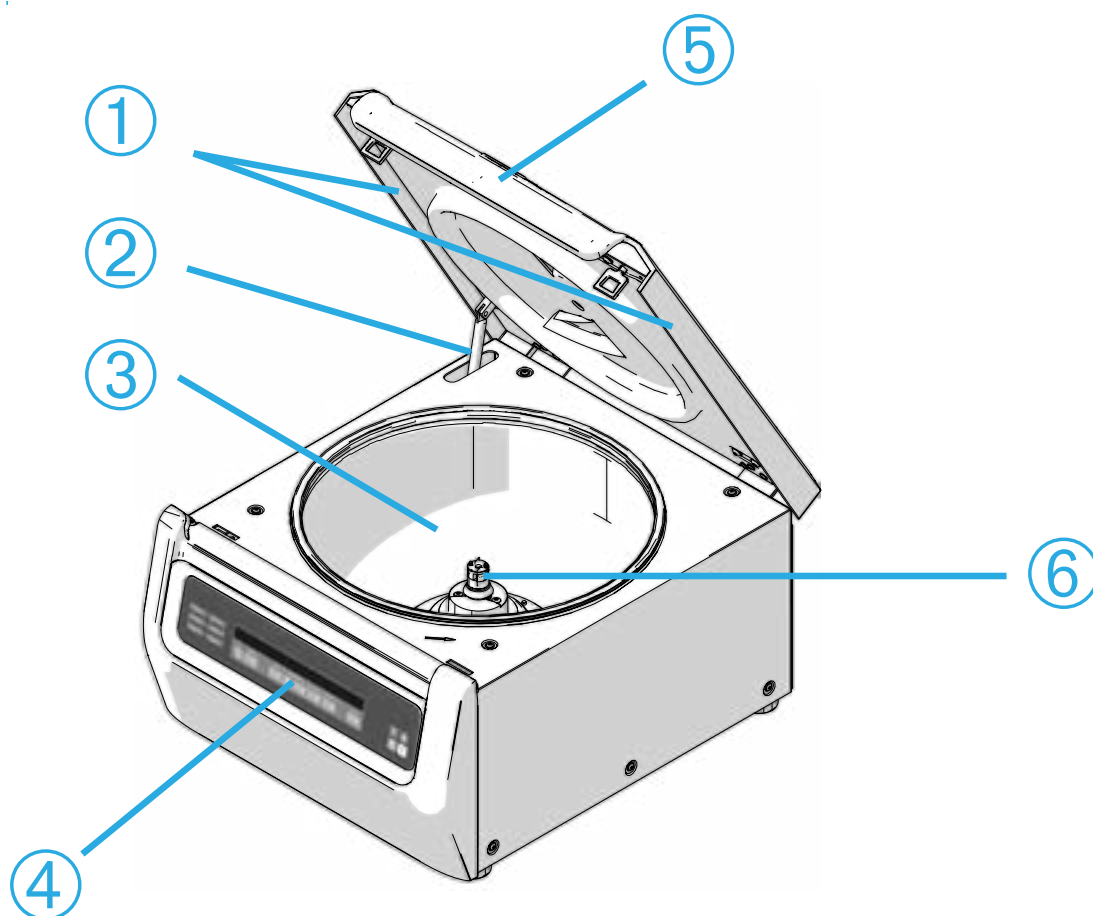

① Particle Deflection Seal; ② Gas spring; ③ Centrifugation chamber; ④ User Interface; ⑤ Centrifuge lid; ⑥ Drive shaft

Figure 2-1: Position of centrifuge parts shown on a ventilated centrifuge with LCD control panel



① Rotor body; ② Cavity; ③ Rotor lid mounting

Figure 2-2: Position of rotor parts shown on a fixed angle rotor



① Slot; ② Key

Figure 2-3: Position of the slot in the bucket and the corresponding adapter key



① Bucket; ② Cap latch; ③ Bucket cap; ④ Rotor knob; ⑤ Auto-Lock button; ⑥ Rotor cross

Figure 2-4: Position of rotor parts shown on a swinging bucket rotor

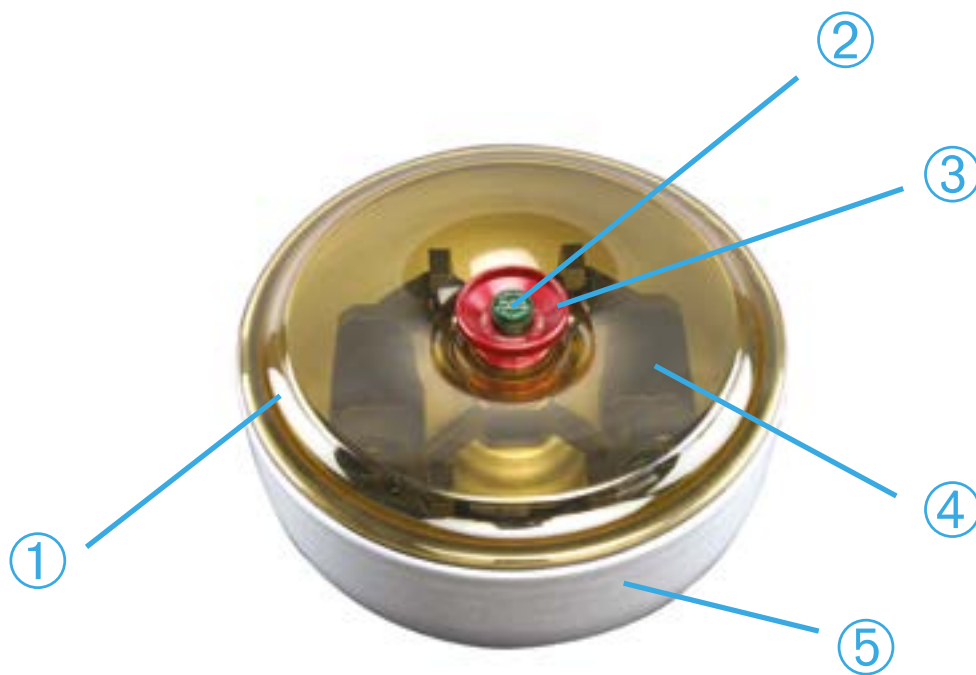

① Rotor lid; ② Auto-Lock button; ③ Rotor lid knob; ④ Rotor cross with buckets within the windshield bowl; ⑤ Windshield bowl

Figure 2-5: Position of rotor parts shown on a windshielded swinging bucket rotor

2. 2. Power on/off the Centrifuge

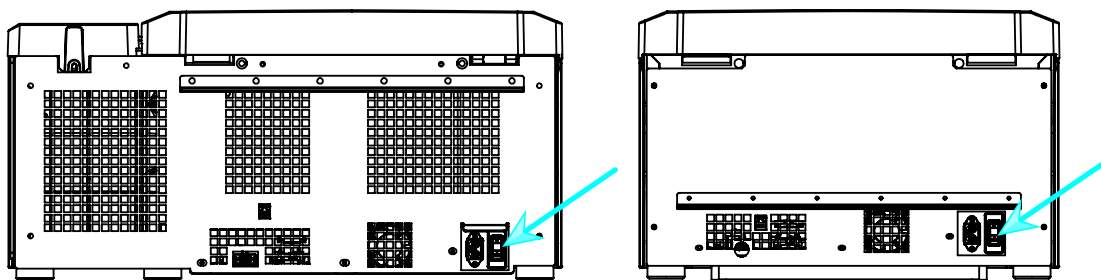

Figure 2-6: Rear view of benchtop centrifuge, position of the mains switch

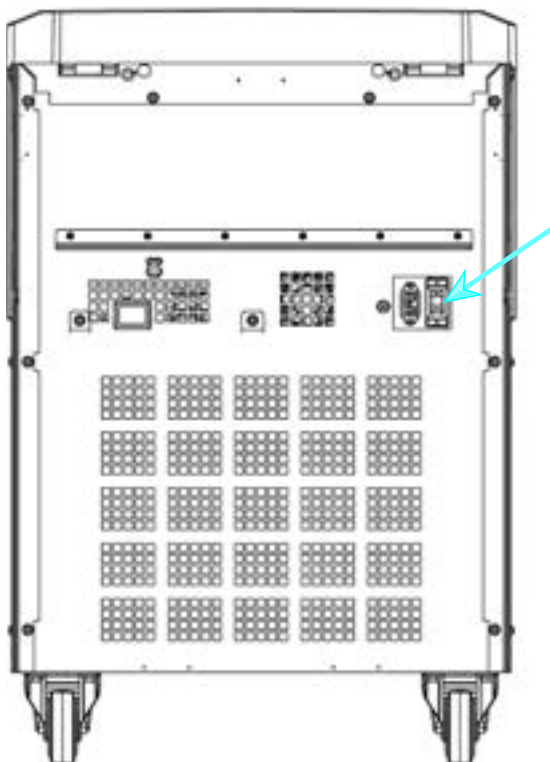

Figure 2-7: Rear view of floorstand centrifuge, position of the mains switch

To power on the centrifuge:

Push on the mains switch of the centrifuge to “1” to power it on.

When the centrifuge has completed booting it is ready for operation.

Once you have started running the centrifuge with your own parameters, it will show the settings from the last session after powering up.

To power off the centrifuge:

Set the mains switch of the centrifuge to “0” to power it off.

2. 3. Open/Close the Centrifuge Lid

To open the centrifuge lid:

Press the Lid Open button  on the home screen of the GUI or  on the LCD control panel.

To close the centrifuge lid:

Close the centrifuge lid by pressing down on it lightly in the middle or on both sides. The locking mechanism engages to close the lid safely. The lid should audibly click into place.

Double-check whether the locking mechanism has engaged properly.

⚠ WARNING Do not reach into the gap between the lid and the casing. The lid is drawn shut automatically and may pinch your fingers.

⚠ **WARNING** Do not use the mechanical emergency door release as regular procedure to open the centrifuge. Use the mechanical emergency door release only if a malfunction or power failure occurs and only when you have made sure that the rotor has stopped spinning (see "Mechanical Emergency Door Release" on page 5-1).

2. 4. How to Install and Remove a Rotor

To install a rotor:



1. Press the Open button  on the home screen of the GUI or  on the LCD control panel to open the lid of the centrifuge.
2. Place the rotor over the drive shaft and let it slide down slowly.
The rotor clicks into place automatically.
3. Make sure that the rotor is properly installed by lifting it slightly on the handle. If the rotor can be pulled up, then it must be reclamped to the drive shaft.
4. Make sure the rotor spins freely by turning it manually.
5. Swinging bucket rotors only: make sure that a full complement of buckets is installed before operating the rotor.
6. Rotor lid installation:
 - a. Put the rotor lid on the rotor.
Make sure the rotor lid is put centered on the rotor.



Figure 2-8: Put on/off the rotor lid

- b. Turn the rotor knob clockwise to close the rotor. Turn it counter-clockwise to open rotor.
There is no need to press the Auto-Lock key to close or open the rotor.

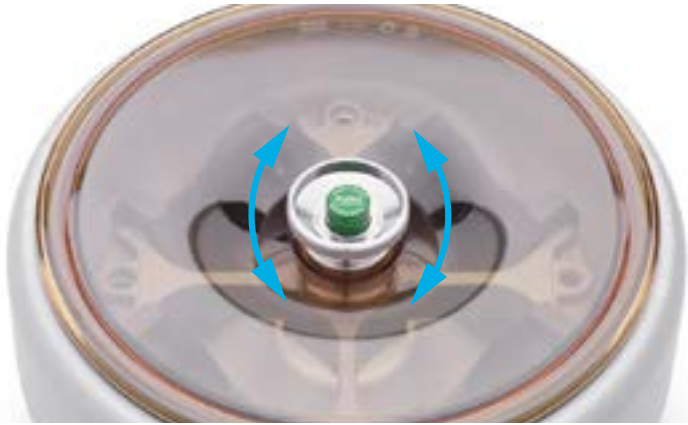

Figure 2-9: Turn the rotor knob

Before installing a rotor:

- Remove any dust, foreign objects or residue from the chamber, if necessary.
- Wipe the drive shaft and the rotor hub from the bottom side of the rotor with a clean cloth.
- Inspect the Auto-Lock and O-ring (Figure 2-11); both must be clean and undamaged.

To remove a rotor:



1. Press the Open button  on the home screen or  on the control panel to open the lid of the centrifuge.
2. Remove samples, adapters or buckets.
3. Grasp the rotor handle with both hands.
4. Press the Auto-Lock key and, at the same time, pull the rotor directly upwards and away from the drive shaft with both hands. Make sure you do not tilt the rotor while lifting it.



Figure 2-10: Pressing the Auto-Lock key

⚠ CAUTION Do not force the rotor onto the drive shaft. If the rotor is very light, it may be necessary to carefully press it onto the drive shaft with little force.

⚠ WARNING If the rotor cannot be properly locked in place after several attempts, then the Auto-Lock is defective and you are not permitted to operate the rotor. Check for any damage to the rotor: Damaged rotors must not be used. Keep the drive shaft area of the rotor clear of objects.

⚠ CAUTION Make sure that the rotor is properly locked on the drive shaft before each use by pulling at its handle.

Supplementary Information



CAUTION

Unapproved or incorrectly combined rotors and accessories can cause serious damage to the centrifuge.

NOTICE

Some rotors may be too heavy to be handled by a single person. Assign a second person to assist when handling a heavy rotor. Refer to "Rotor Specifications" on page B-1 for the weight of a rotor.

The approved rotors are listed in the “Rotor Program” on page A-8. Operate the centrifuge only with rotors and accessories from this list. Make sure that all components of a rotor are safely fixed when carried.

The centrifuge is equipped with a Thermo Scientific™ Auto-Lock™ locking feature that automatically locks the rotor to the drive shaft.

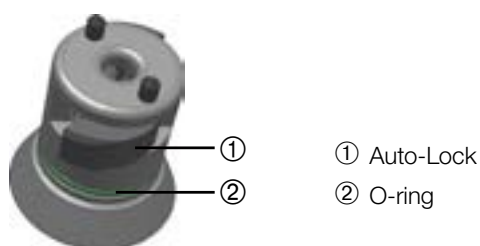

Figure 2-11: Auto-Lock on the drive shaft

2. 5. Load the Rotor

2. 5. 1. Assembling TX-400 Round Buckets and Adapters

When running a 75003655 round bucket with a 75003683 or 75003682 adapter make sure that you assemble the bucket and adapter correctly.

The adapters have a rounded key feature that fits into a matching slot in the bucket. If the key is not in the slot, the bucket cap will not close properly and the centrifuge will not start and may cause damage to bucket, adapter and the sample.

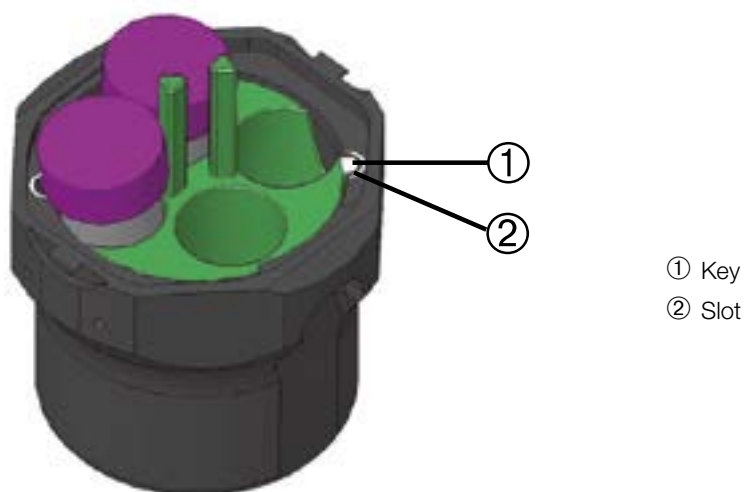

Figure 2-12: Slot and Key on Paired Buckets and Rotors

2. 5. 2. Balance Loading

Load the compartments evenly. Balance opposite loads.

When using swinging bucket rotors mind the following in addition:

- Weigh the bucket content (adapter and tube). Make sure you do not exceed the maximum compartment load nor the weight difference limit for adjacent buckets if there is one for the rotor.
- Make sure to install all buckets if using swinging bucket rotors. Make sure you install an identical bucket type in opposite positions.
- If in doubt, contact Thermo Fisher Scientific customer service.

Correct Loading ✓

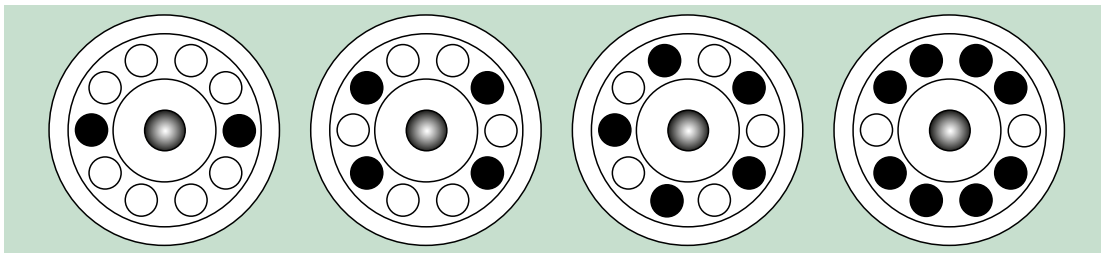

Figure 2-13: Correct loading examples for fixed angle rotors

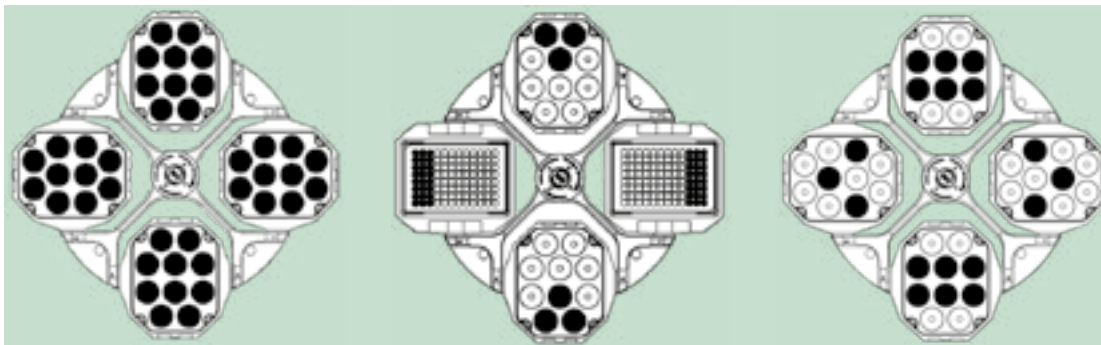

Figure 2-14: Correct loading examples for swinging bucket rotors

Incorrect Loading ✗

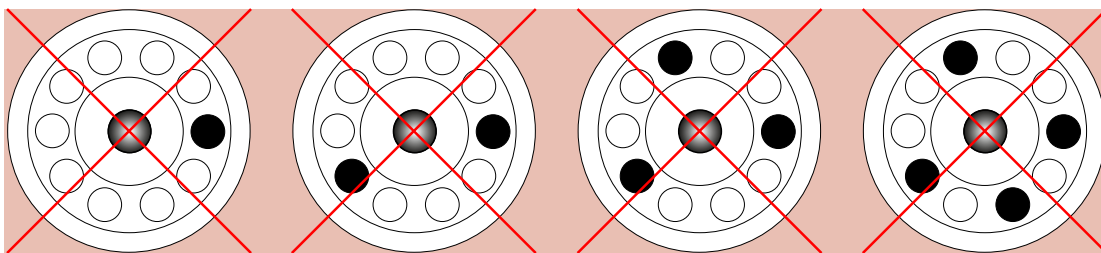

Figure 2-15: Incorrect loading examples for fixed angle rotors

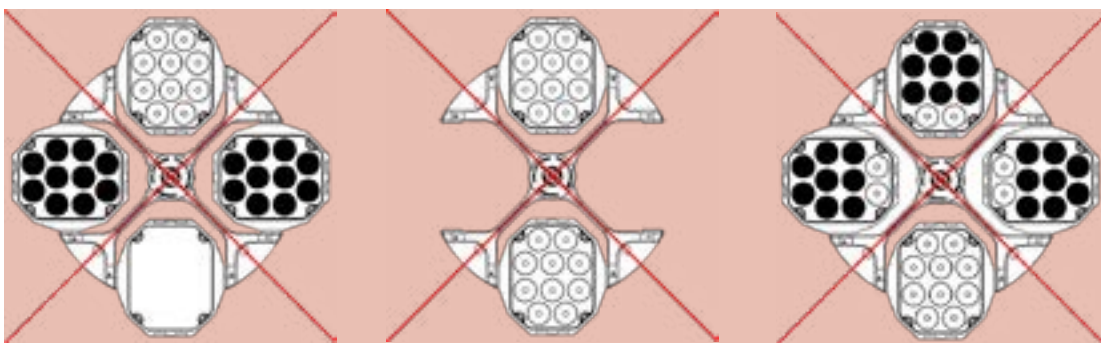





Figure 2-16: Incorrect loading examples for swinging bucket rotors

Before loading a Rotor

1. Inspect the rotor and all accessory parts for damage, such as cracks, scratches, or traces of corrosion.
2. Inspect the centrifugation chamber, drive shaft and Auto-Lock device for damage, such as cracks, scratches, or traces of corrosion.
3. Check the suitability of the rotor and other used accessories against the Chemical Compatibility Chart. Refer to “Chemical Compatibility” on page C-1.
4. Make sure that:
 - » tubes or bottles fit in the rotor.
 - » the tubes or bottles do not touch the rotor lid or bucket caps.
 - » buckets or microplate carrier can swing freely by moving them carefully with your hand.

 **CAUTION** Incorrect loading can lead to damage. Always load the rotor symmetrically to avoid imbalance, noisy spinning and possible damage. A full complement of buckets needs to be installed before operating a swinging bucket rotor.

 **CAUTION** When using an aerosol-tight rotor lid or bucket caps, verify that the sample tubes don't interfere with the rotor lid or bucket cap and don't compromise its sealing efficiency.

 **CAUTION** Always use 2 identical bucket types in opposite positions. Make sure that opposite buckets are of the same weight class, if a weight class is labeled on the buckets.

 **CAUTION** Tubes may open and break during centrifugation because they do not fit properly to the cavities. Contamination may occur. Make sure that the length and width of the tubes are fitting into the adapter and cavities. Do not use tubes that are too short or too thick for the adapter and the cavities.

2. 5. 3. Maximum Loading

Each rotor is designed to run with its maximum load at maximum speed. The safety system of the centrifuge requires that the rotor is not overloaded.

The rotors are designed to work with substance mixtures with a density of up to 1.2 g/ml. If the admissible maximum load is exceeded, the following steps need to be taken:

- Reduce the fill level.
- Reduce the speed.

Use the following formula or the table given for each rotor in the chapter "Rotor Specifications" on page B-1 to calculate the maximum admissible speed for a given load:

$$n_{\text{adm}} = n_{\text{max}} \sqrt{\frac{w_{\text{max}}}{w_{\text{app}}}}$$

n_{adm} = admissible maximum application speed

n_{max} = maximum rated speed

w_{max} = maximum rated load

w_{app} = applied load

RCF Value Explained

The relative centrifugal force (RCF) is given as a multiple of the force of gravity (g). It is a unitless numerical value which is used to compare the separation or sedimentation capacity of various centrifuges, since it is independent of the type of device. Only the centrifuging radius and the speed are used for calculation:

$$\text{RCF} = 11,18 \times \left(\frac{n}{1000}\right)^2 \times r$$

r = centrifuging radius in cm

n = rotational speed in rpm

The maximum RCF value is related to the maximum radius of the tube opening.

Remember that this value is reduced depending on the tubes, buckets and adapters used.

This can be accounted for in the calculation above if required.

2. 5. 4. Use of Tubes and Consumables

Make sure that the tubes and bottles used in the centrifuge are:

- rated to or above the selected RCF to be spun at,
- used at their minimum fill volume and not above their maximum fill volume,
- not used above their design life (age or number of runs),
- undamaged,
- fitting well into the cavities.

Please refer to manufacturers' data sheets for further information.

2. 6. Identify Rotor and Buckets

The centrifuge has a rotor detection that identifies an installed rotor. If a swing-out rotor is identified, the centrifuge prompts you to identify the bucket type installed in that rotor.

Rotor detection relies on a list of rotors stored in the memory of the centrifuge. If an unknown rotor is detected, please contact customer service. An update for that rotor list might be available to accommodate new rotor models.

To identify a newly installed rotor and its buckets using a centrifuge with a GUI:

After installing the rotor, close the centrifuge lid and start the centrifuge using the Start button ►. Wait for the "Rotor Detection" prompt to appear.



Figure 2-17: Rotor Detection: Choosing a Bucket Type for a TX-750 Rotor

- » Swinging bucket rotors with a choice of bucket types: Tap the "**buckets**" pop-up menu and choose the bucket type installed in your rotor.

If there is no need to confirm bucket type in the future—for example, because you use just one bucket type throughout, select the "Do not show this message again" checkbox.

This setting can be undone at any time using the "Bucket" setting.

Tap the **Save** button to confirm your changes.

The rotor has been successfully detected, and the centrifuge is ready for use now.

The rotor detected by the centrifuge and the bucket type identified by the user appear.

If the rotor is unknown to the centrifuge, the "Unknown Rotor Detected" pop-up window will be shown. Tap the Cancel button to close this pop-up window, remove the unknown rotor, and replace it with a known type.

To identify buckets using a centrifuge with a LCD control panel:

Bucket selection is only possible for swing-out rotors. The bucket code corresponds to the last four digits of the bucket article number.

Proceed as follows to select the bucket type installed in the rotor:

1. Press the + or - button below the "Bucket" field of the LCD display window (see Figure 2-18) to select the correct bucket code for the buckets installed in your rotor.



Figure 2-18: Setting the Correct Bucket Code

2. Press the **Bucket** key repeatedly until the bucket code of the bucket being used is displayed.
 3. Release the **+** or **-** button when the desired bucket code appears above the button.
- Doing so selects the bucket code for future centrifugation runs (until the next time you choose to change this setting).

2. 7. Set Basic Centrifugation Parameters

NOTICE

For more details on settings refer to “LCD Control Panel” on page 3-1.

Set Speed / RCF-Value

The centrifuge lets you set speed in rpm or as an RCF value (see “RCF Value Explained” on page 2-9). You may set speed either from within an ongoing centrifugation run (centrifuge running) or for the next centrifugation run (centrifuge at standstill).

Set Run Time

The centrifuge lets you set a run time after which the centrifugation run stops automatically.

Acceleration and Deceleration Profiles

The centrifuge offers a total of 9 acceleration profiles (numbered 1 through 9) and total of 10 deceleration profiles or braking curves (numbered 0 through 9) for centrifuging samples with a selected speed profile. An acceleration profile gradually increases the speed of the centrifuge after starting the centrifugation run. A deceleration profile gradually reduces the speed of the centrifuge towards the end of the centrifugation run.

NOTICE Avoid if possible speed ranges close to natural resonances of the system. Runs at resonance speeds may have show vibration and an adverse effect on the quality of separation.

Set Temperature

A refrigerated centrifuge allows for preselecting a temperature for the sample between -10 °C and +40 °C for the centrifugation run. This feature is not available on ventilated models.

2. 8. Pre-Temper the Centrifugation Chamber

Refrigerated centrifuges allow for pre-tempering, that is pre-warming or pre-cooling, the centrifugation chamber and the empty rotor before the centrifugation run starts. If necessary pre-temper your samples using proper equipment. The centrifuge is not intended to be used to pre-temper your samples.

NOTICE Ventilated models cannot pre-temper the centrifugation chamber.

2. 9. Centrifugation



WARNING

Damage to health from centrifuging explosive or flammable materials or substances. Do not centrifuge explosive or flammable materials or substances.







CAUTION

Due to air friction sample integrity may be affected.
The temperature of the rotor may rise significantly while the centrifuge is spinning.
Ventilated units lead to a heat up of the rotor above the ambient temperature.
Refrigerated units can have a deviation from displayed and set temperature to the sample temperature.
Make sure the centrifuge temperature control capabilities meet your application specification. If necessary make a test run.





Mind the safety zone of minimum 30 cm around the centrifuge. Refer to “Safety Zone” on page 1-2. Persons and hazardous substances must be kept out of this safety zone while centrifuging.

Once the main switch has been turned on, the rotor has been properly installed, the setpoints have been set as explained in the previous section, and the centrifuge lid has been closed, you are ready to start.

You have various options to start a centrifugation run with a GUI:

- **Continuous Mode:** This is a fully manual mode. If you have chosen Continuous Mode instead of a preset runtime, use the Start button  and Stop button  to start and stop centrifugation manually.
- **Timed Mode:** This is a semi-automatic mode that relies on a timer. If you have preset a runtime, tap the Start button , then and wait for the timer to expire and the centrifuge to stop automatically.
- **Pulse Mode:** This is a short-run centrifugation mode with selectable behaviors. You choose a behavior, then tap the Pulse button  and wait for the centrifuge to run and stop automatically.
- **Program Mode:** This is a fully automatic mode. You prepare and save an automated program, then run it from the touchscreen.

You have various options to start a centrifugation run with a LCD control panel:

- **Continuous Mode:** This is a fully manual mode. In Continuous Mode you use the **Start** key  and **Stop** key  to start and stop centrifugation manually, as explained in the section “Continuous Operation” further below.
- **Timed Mode:** This is a semi-automatic mode that relies on a timer. If you have preset a runtime (see “3. 2. 2. Set Run Time” on page 3-3), you press the **Start** key , then wait for the timer to expire and the centrifuge to stop down automatically.
- **Program Mode:** This is a fully automatic mode. You prepare and save an automated program, as explained in the section “Setting Up and Saving a Program” on page 3-6, then run it by pressing the appropriate program selection key .

NOTICE

For more details on settings refer to “LCD Control Panel” on page 3-1.

2. 10. Aerosol-Tight Applications

2. 10. 1. Basic Principles

Make sure that the sample containers are well suited for the desired centrifugation process.



CAUTION

Aerosol-tight rotors and tubes may only be opened in an approved safety work-bench when centrifuging dangerous samples. Mind the maximum permissible load.



CAUTION

Be sure to check all sealings before starting any aerosol-tight applications.

2. 10. 2. Fill Level

Do not fill the tubes beyond a safe level to prevent the sample from reaching the top of the tube during centrifugation. To be on the safe side, fill the tubes only to 2/3 of the rated level.

2. 10. 3. Aerosol-Tight Rotor Lids



Figure 2–19: Lid of an aerosol-tight rotor with mandrel

Placing O-ring

The O-ring fulfills its purpose best, when it is neither excessively stretched nor bulged. The O-ring shall be equally placed in the groove of the lid.

Place the O-ring as follows:

1. Place the O-ring above the groove.
2. Push the O-ring on two opposite places into the groove. Make sure the rest of the O-ring is equally distributed.
3. Push the centers of the loose parts into the groove.
4. Push the remaining O-ring into place.

NOTICE If the O-ring seems to be too long or too short, take it off the lid and repeat the process.



CAUTION

When using an aerosol-tight rotor lid, verify that the sample tubes do not interfere with the rotor lid and compromise its sealing efficiency.



CAUTION

Rotors supplied with a lid for aerosol-tight applications come with a mandrel as an accessory to the Auto-Lock device. Be sure not to place the lid on this mandrel. The lid may be damaged.

2. 10. 4. Aerosol-Tight Rotor Buckets

Aerosol-tight Closure with ClickSeal

1. If necessary, grease the lid joint before closing the lid. Use grease (76003500) for this.
2. Raise the latch.
The cap can now be easily placed on the bucket.
3. Lower the latch to close the bucket aerosol-tight; be sure the latch clicks into place.
Make sure that both sides of the latch are closing the bucket cap.



Figure 2-20: Bucket with open lid (left) and closed lid (right)



CAUTION

If the latch is not flipped down, the caps could be damaged during centrifugation. If the latch has not clicked into place, the bucket is not aerosol-tight. Never lift the bucket at its latch.



CAUTION

Make sure that the length of tubes used allow proper closing of the bucket cap. Otherwise the bucket will not be aerosol-tight.

2. 10. 5. Checking the Aerosol-Tightness

The aerosol-tightness testing of the rotors and buckets depends on the microbiological test process in accordance with the EN 61010-2-020 Appendix AA.

Whether or not a rotor is aerosol-tight depends primarily on proper handling.

Make sure that your rotor is aerosol-tight.

The careful inspection of the seals and seal surfaces for signs of wear and damage such as cracks, scratches and embrittlement is extremely important.

Aerosol-tight applications are not possible if the rotor is run without the lid.

Aerosol-tightness requires the correct operation when filling the sample vessels and closing the rotor lid.

Quick Test

As a quick test, it is possible to test the aerosol-tightness using the following process:

1. Lubricate all seals lightly.
Always use the special grease (76003500) when lubricating the seals.
2. Fill the bucket with approx. 10 ml of carbonated mineral water.
3. Close the bucket as explained in the handling instructions.
4. Shake the bucket vigorously using your hands.

This releases the carbonic acid gas which is bound in the water, resulting in excess pressure. Do not apply pressure to the lid when doing so.

Leaks can be detected by escaping water or the sound of escaping gas.

Replace the seals if you detect any leaks. Then repeat the test.

Dry the rotor, rotor lid and the cover seal.

⚠ CAUTION Prior to each use, the seals in the rotor are to be inspected in order to assure that they are correctly seated and are not worn or damaged. Damaged seals are to be replaced immediately. Replacement seals can be re-ordered as a spare part ("Rotor Specifications" on page B-1). When loading the rotor, ensure that the rotor lid closes securely. Damaged rotor covers are to be replaced immediately.



CAUTION

This quick test is not suited for validating the aerosol tightness of a rotor. Check the seals and sealing surfaces of the lid thoroughly.

3. LCD Control Panel

This chapter contains details for the centrifuges with the LCD display described in this manual. Pictures shown are examples and may be different in details to your experience—for example, the LCD display for a ventilated unit does not have a key for entering temperature, nor a temperature readout.

NOTICE This chapter shows examples for refrigerated models only.

3.1. Overview

The LCD display combines a single-line LCD (Liquid Crystal Display) screen with membrane-protected keys for choosing commands or increasing and decreasing parameter values. Figure 3–1 presents the arrangement of the LCD screen areas and keys described in the following.

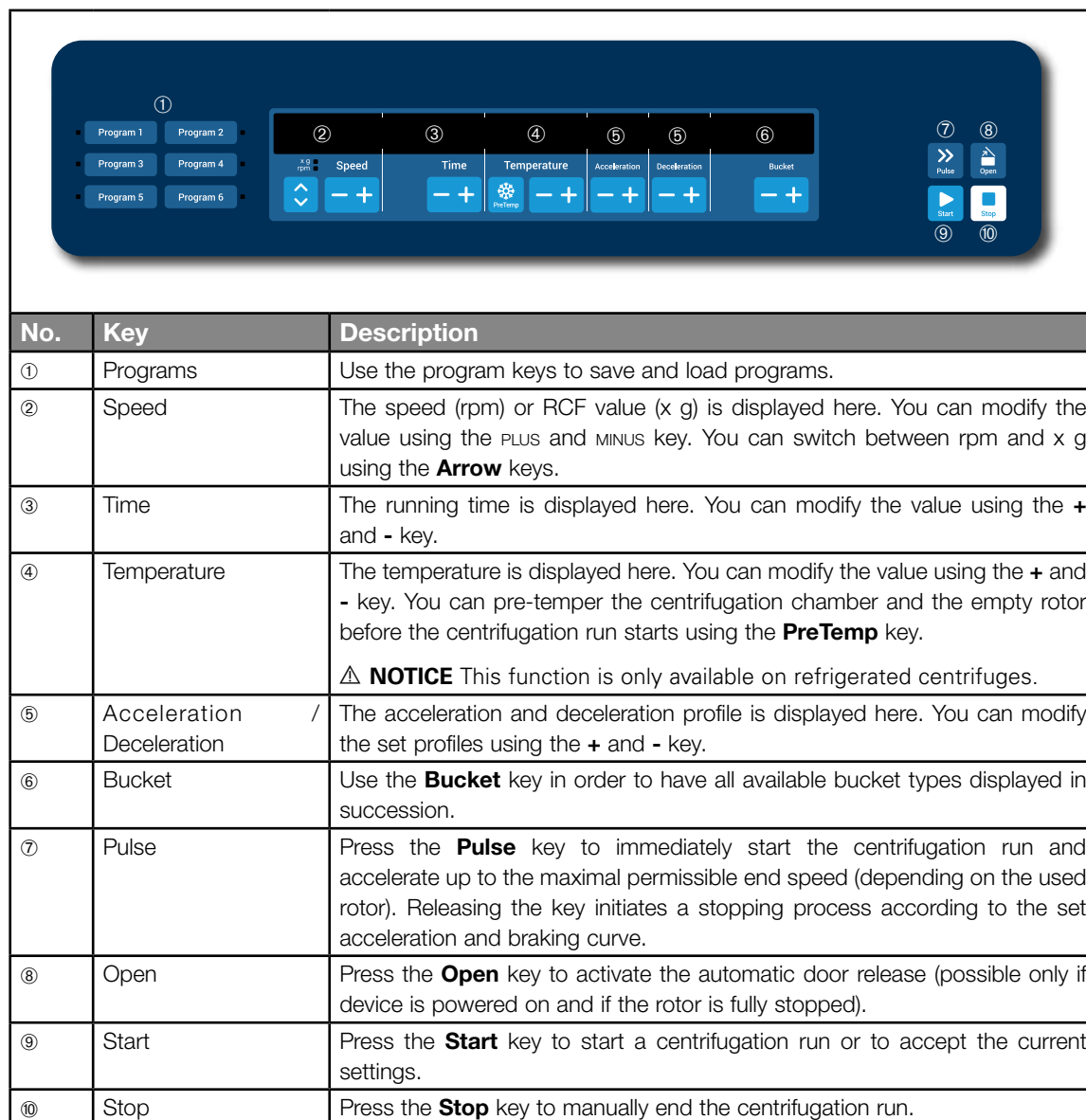

Figure 3–1: Functions on the LCD Control Panel

3. 2. Set Basic Centrifugation Parameters

This section explains how to set up the centrifuge with speed / RCF values, acceleration and deceleration profiles, temperature (refrigerated models only), and other operating parameters.

3. 2. 1. Set Speed / RCF-Value

The centrifuge lets you set speed in rpm or as an RCF value (see “RCF Value Explained” below). You may set speed either from within an ongoing centrifugation run (centrifuge running) or for the next centrifugation run (centrifuge at standstill).

RCF Value Explained

The relative centrifugal force (RCF) is given as a multiple of the force of gravity (g). It is a unitless numerical value which is used to compare the separation or sedimentation capacity of various centrifuges, since it is independent of the type of device. Only the centrifuging radius and the speed are used for calculation:

$$RCF = 11,18 \times \left(\frac{n}{1000} \right)^2 \times r$$

r = centrifuging radius in cm

n = rotational speed in rpm

The maximum RCF value is related to the maximum radius of the tube opening.

Remember that this value is reduced depending on the tubes, buckets and adapters used.

This can be accounted for in the calculation above if required.

Proceed as follows to set a speed or RCF value:

1. Press the **Arrow** keys below the xg / rpm LED indicators (left in Figure 3–2) to toggle between RCF (in xg, which means multiples of the force of gravity) and speed (in rpm, which is short for revolutions per minute).

The LED indicator **xg** or **rpm** is lit to indicate the selected mode, and the value in the LCD display switches to an **RCF** or **rpm** reading. The example in Figure 3–2 shows the rpm reading (bottom) and the equivalent RCF reading (top).

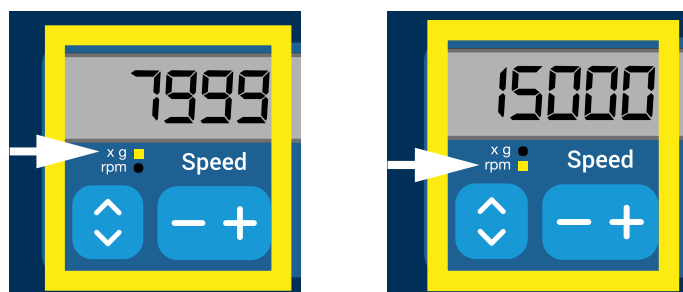

Figure 3–2: Choosing between RCF / rpm and setting the Centrifuge Speed

2. Press the **+** or **-** key below the **Speed** field of the LCD display to set the desired value.

NOTICE If you select an extremely low RCF value, it will be automatically corrected if the resulting speed is less than 300 rpm. 300 rpm is the lowest selectable speed.

3. Release the **+** or **-** key when the desired value appears.

Doing so selects the speed setting for future centrifugation runs (until the next time you choose to change this setting).

3. 2. 2. Set Run Time

The centrifuge lets you preset a run time after which the centrifugation run stops automatically.

Proceed as follows to set run time:

1. Press the **+** or **-** key below the **Time** field of the LCD display to set the desired duration for the centrifugation run.

The value displayed in the **Time** field (see Figure 3–3 below) changes accordingly.

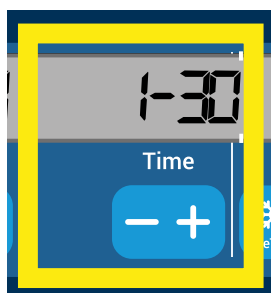

Figure 3–3: Setting the Centrifuge Run Time

2. Release the key when the desired runtime in hours and minutes appears.

Doing so selects the runtime setting for future centrifugation runs (until the next time you choose to change this setting) .

3. 2. 3. Set Acceleration and Deceleration Profiles

The centrifuge offers a total of 9 acceleration curves (numbered 1 through 9). An acceleration curve gradually increases the speed of the centrifuge after starting the centrifugation run. An acceleration profile gradually increases the speed of the centrifuge after starting the centrifugation run. A deceleration profile gradually reduces the speed of the centrifuge towards the end of the centrifugation run.

NOTICE After the centrifuge is turned on, the last running profile selected is shown.

NOTICE Avoid if possible speed ranges close to natural resonances of the system. Runs at resonance speeds may have show vibration and an adverse effect on the quality of separation.

Acceleration Profile

Proceed as follows to select an acceleration curve:

1. Press the **+** or **-** key below the **Acceleration** field of the LCD display to cycle through the selection of available acceleration profiles.

Curve number 1 provides the slowest and curve number 9 the fastest acceleration rate.

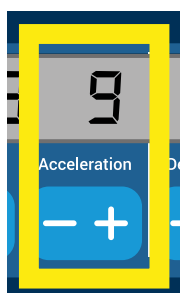

Figure 3–4: Setting the Acceleration Profile

2. Release the **+** or **-** key when the number of the desired acceleration profile appears in the display window.

Doing so selects the acceleration profile for future centrifugation runs (until the next time you choose to change this setting) .

Deceleration Profiles

The centrifuge offers a total of 10 deceleration or braking curves (numbered 0 through 9). A deceleration curve gradually reduces the speed of the centrifuge towards the end of the centrifugation run.

NOTICE After the centrifuge is turned on, the last running profile selected is shown.

Proceed as follows to select a braking curve:

1. Press the **+** or **-** key below the **Deceleration** field of the LCD display window to cycle through the selection of available deceleration profiles.

Curve number 0 disables active deceleration altogether. Curve number 1 provides the slowest active and curve number 9 the fastest active deceleration rate.

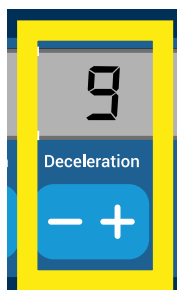

Figure 3-5: Setting the Deceleration Profile

2. Release the **+** or **-** key when the number of the desired deceleration profile appears in the display window. Doing so selects the deceleration profile for future centrifugation runs (until the next time you choose to change this setting).

3. 2. 4. Pre-Temper the Centrifugation Chamber

Refrigerated centrifuges allow for pre-tempering, that is pre-warming or pre-cooling, the centrifugation chamber and the empty rotor before the centrifugation run starts. If necessary pre-temper your samples using proper equipment. The centrifuge is not intended to be used to pre-temper your samples. Temperatures displayed by the centrifuge are the estimated sample temperatures.

NOTICE This feature is not available on ventilated models.

To set the pre-tempering temperature for the centrifuge, proceed as follows:

1. Insert the rotor with all buckets installed.
2. Press the **PreTemp** key to enable pre-tempering adjustment.

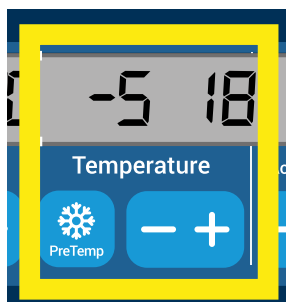

Figure 3-6: Setting the Pre-cooling or Pre-warming Temperature (left)

3. Press the **+** or **-** key and hold it until the desired temperature appears.
4. Release the **+** or **-** key when the desired temperature appears above the **PreTemp** key. The centrifuge starts heating or cooling the rotor chamber to the preset temperature. The current rotor chamber temperature displayed to the right of the selected pre-tempering value starts to change towards the desired value.
5. Wait until the sample chamber temperature indicator is at the same value as the pre-tempering temperature.

3. 2. 5. Set Temperature

A refrigerated centrifuge allows for preselecting a rotor chamber temperature between -10 °C and +40 °C for the centrifugation run. Temperatures displayed by the centrifuge are the estimated sample temperatures.

⚠ CAUTION Due to air friction sample integrity may be affected.

The temperature of the rotor may rise significantly while the centrifuge is spinning.

Refrigerated units can have a deviation from displayed and set temperature to the sample temperature.

Make sure the centrifuge temperature control capabilities meet your application specification. If necessary make a test run.

NOTICE This feature is not available on ventilated models.

Proceed as follows to preselect a temperature for the centrifugation run:

1. Press the **+** or **-** key below the **Temperature** field of the LCD display window (right side of Figure 3–7, showing 18 degrees Celsius) to adjust the desired rotor chamber temperature.

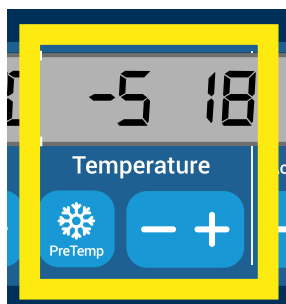

Figure 3–7: Setting the Temperature for the Centrifugation Run (right)

2. Release the **+** or **-** key when the desired temperature appears above the key.

Doing so selects the temperature for future centrifugation runs (until the next time you choose to change this setting) .

3. 2. 6. Select the Bucket Type

Bucket selection is only possible for swing-out rotors. The bucket code corresponds to the last four digits of the article number of the bucket.

Proceed as follows to select the bucket type installed in the rotor:

1. Press the **+** or **-** key below the **Bucket** field of the LCD display window (see Figure 3–8) to select the correct bucket code for the buckets installed in your rotor.



Figure 3–8: Setting the Correct Bucket Code for the Rotor

2. Press the **Bucket** key repeatedly until the bucketcode of the bucket being used is displayed.
3. Release the **+** or **-** key when the desired bucket code appears above the key.

Doing so selects the bucket code for future centrifugation runs (until the next time you choose to change this setting).

3.3. Programs

To reduce the setup effort before a centrifugation run, the centrifuge lets you enter a selection of desired program parameters and store them together as a program that may be retrieved for later use. You can include all or part of the run parameters explained in previous sections of this chapter, including:

- acceleration and braking profile
- speed or RCF value
- running time
- temperature
- bucket type by code

Setting Up and Saving a Program

All centrifuge models described in this section let you store up to six programs using dedicated front panel keys. You can retrieve and start the programs later on by pressing the program key assigned during storage.

Proceed as follows to store a program:

1. Set your choice of run parameters in one go, as explained for your centrifuge model in the previous sections of this chapter.
2. Press any of the program selection keys  for 4 seconds.

Your program is stored now.





For instructions on how to start a previously stored program, please refer to the section “Program Mode Operation” on page 3-7.

3.4. Centrifugation

Mind the safety zone of minimum 30 cm around the centrifuge. Refer to “Safety Zone” on page 1-1. Persons and hazardous substances must be kept out of this safety zone while centrifuging.

Once the rotor has been properly installed, the main power switch has been turned on and the centrifuge lid has been closed, you are ready to start centrifuging.

You have various options to start a centrifugation run:

- Continuous Mode: This is a fully manual mode. In Continuous Mode you use the **Start** key  and **Stop** key  to start and stop centrifugation manually, as explained in the section “Continuous Operation” further below.
- Timed Mode: This is a semi-automatic mode that relies on a timer. If you have preset a runtime (see “3. 2. 2. Set Run Time” on page 3-3), you press the **Start** key , then wait for the timer to expire and the centrifuge to stop automatically.
- Program Mode: This is a fully automatic mode. You prepare and save an automated program, as explained in the section “Setting Up and Saving a Program” on page 3-6, then run it by pressing the appropriate program selection key .



WARNING

Damage to health from centrifuging explosive or flammable materials or substances. Do not centrifuge explosive or flammable materials or substances.

Continuous Mode Operation

Proceed as follows to run the centrifuge in continuous, manual stop mode of operation.

1. Set the desired parameters, as explained in the section “3. 2. Set Basic Centrifugation Parameters” on page 3-2.

NOTICE Speed (see “3. 2. 1. Set Speed / RCF-Value” on page 3-2) must be set as a minimum requirement.

2. Press the **Start** key  on the control panel.

The centrifuge starts running up to the pre-set speed. The LCD display changes to reflect the acceleration process until the centrifuge reaches the pre-set speed.

When the centrifuge has accelerated to the pre-set speed, the timer starts counting the elapsed time.

3. Press the **Stop** key  when you have finished centrifuging.

NOTICE You cannot open the lid as long as the centrifuge is spinning.

Timed Mode Operation

Proceed as follows to run the centrifuge in timed mode of operation.

1. Set the desired parameters, as explained in the section “3. 2. Set Basic Centrifugation Parameters” on page 3-2.

NOTICE Speed (see “3. 2. 1. Set Speed / RCF-Value” on page 3-2) and runtime (see “3. 2. 2. Set Run Time” on page 3-3) must be set as a minimum requirement.

2. Press the **Start** key  on the control panel.

The centrifuge starts running and the LCD display changes to indicate the correct speed.

When the centrifuge has accelerated to the pre-set speed, the timer starts counting the remaining time.

3. When the remaining time has elapsed, the centrifuge will stop automatically.

NOTICE You cannot open the lid as long as the centrifuge is spinning.

Program Mode Operation

Proceed as follows to start a previously stored program.

1. Press any of the program selection keys  to select a program.

NOTICE There is no need to set any parameters. All settings are included in the program.

2. Press the **Start** key  to start the centrifugation run with the selected program's settings.

The centrifuge starts running up to the pre-set speed.

The LCD display changes to reflect the acceleration process until the centrifuge reaches the pre-set speed.

When the centrifuge has accelerated to the pre-set speed, the timer starts counting the remaining time.

3. When the remaining time has elapsed, the centrifuge will stop automatically.

NOTICE You cannot open the lid as long as the centrifuge is spinning.

Handling Error Messages

Error messages may occur when you try to start the centrifuge. Frequent root causes include the following:

- Set speed exceeds admissible speed for rotor
- Imbalanced load
- Unapproved rotor found by rotor detection

A detailed list of error messages and troubleshooting instructions appear in the section “Troubleshooting by Guide” on page 5-2.

3. 5. Stop an Ongoing Centrifugation Run

You can stop the centrifuge at any time by pressing the **Stop** key  on the control panel.

Proceed as follows to stop an ongoing centrifugation run:

1. Press the **Stop** key  on the control panel.
2. Wait for the speed drop to zero.

The message END appears in the LCD display.

You can now open the lid and remove the centrifuged material, as explained in “How to Install and Remove a Rotor” on page 2-5.

3. 6. System Menu

To enter the system menu hold down any of the keys when powering on the centrifuge.

Use the + and - keys below Speed in order to navigate through the system menu.

Use the + and - keys below Bucket in order to navigate within the system menu points.

Within the system menu you can change the settings of the centrifuge. Following settings are available:

1. Language – following languages are supported: English, German, French, Spanish, Italian, Dutch, Russian.
2. End of run beep – select **YES** if the centrifuge shall make beep after the run. Otherwise select **NO**.
3. Keypad beep – select **YES** if the centrifuge shall make beep when pressing any key. Otherwise select **NO**.
4. LCD powersave – select **YES** if the centrifuge shall enter a powersave mode after the run. Otherwise select **NO**.
5. Auto lid open – select **YES** if the centrifuge shall open after the run. Otherwise select **NO**.
6. Software ID – the current software version is shown here.
7. Cycle count – the current numbers of cycles are shown here.

4. Maintenance and Care

4.1. Cleaning Intervals

For the sake of personal, environmental, and material protection, you must clean and if necessary disinfect the centrifuge and its accessories on a regular basis.

4.2. Basics

- Use warm water with a neutral detergent that is suitable for use with the materials. If in doubt contact the manufacturer of the cleaning agent.
- Use a soft cloth for cleaning.
- Never use caustic cleaning agents such as soap suds, phosphoric acid, bleaching solutions or scrubbing powder.
- Remove rotor and clean centrifugation chamber with a small amount of cleaning agent on a clean cloth.
- Use a soft brush without metal bristles to remove stubborn residue.
- Afterwards rinse with a small amount of distilled water and remove any remains with absorbent towels.
- Use only cleaning and disinfecting agents with a pH of 6-8.



CAUTION

Not rated procedures or agents could deteriorate the materials of the centrifuge and lead to malfunction. Refrain from using any other cleaning or decontamination procedure, if you are not entirely sure that the intended procedure is safe for the equipment. Use only cleaning agents that will not damage the equipment. In doubt contact the manufacturer of the cleaning agent. If still in doubt, contact Thermo Fisher Scientific.

4.2.1. Rotor and Accessories Inspection

After thoroughly cleaning the rotors, they must be inspected for damage, wear and corrosion.

The cycle limits of the rotors and buckets are stated on some rotors and buckets and in the technical data section of each rotor ("Rotor Specifications" on page B-1).

NOTICE Usage beyond these limits might lead to rotor failure, sample loss and damage to the centrifuge.



CAUTION

Do not run any rotor or accessories with sign of damage. Ensure that the rotor, buckets and accessories are within their expected maximum number of cycles. It is recommended that you have rotors and accessories inspected yearly as part of your routine service to ensure safety.

Metal Parts

Make sure that the protective coating is complete. It can be removed through wear and chemical attack and can lead to unseen corrosions. In case of corrosion, such as rust or white / metallic pitting, the rotor or accessories must be removed from service immediately. Particular attention should be paid to the bottom of buckets on swinging bucket rotors and tube cavities on fixed angle rotors.

Slide Coated Rotors

Rotor crosses are provided with an anti-friction and corrosion resistant finish.

The following procedure is for rotor crosses and rotor trunnion bolts:

- Regular cleaning of contact area between the rotor and buckets (rotor cross trunnions and bucket grooves) is recommended with a mild detergent (every 300-500 cycles).
- The rotor cross is coated with a special advanced lubricating and protective coating, therefore no grease is necessary.
- Contaminating particles (dirt, dust or debris) in the rotor cross and bucket grooves may lead to imbalance and cleaning will be required.
- The lubricating coating may, over extended periods or under heavy loads, become worn. If this occurs a small amount of greasing of the rotor cross trunnions will be required with bolt grease (75003786).

Plastic Parts

Check for signs of plastic crazing, fading, bruising or cracking. In case of damage the inspected item must be removed from service immediately.

O-Rings

Make sure that O-rings are still smooth, not brittle nor otherwise damaged. Some O-rings are not autoclavable. Replace brittle or damaged O-rings immediately. Refer to “Rotor Specifications” on page B-1 for details on O-rings as spare part.

4. 2. 2. Cycles of Rotors and Buckets

You have to count the cycles of the rotors and buckets using your own method. The centrifuge can not detect the change or replacement of rotors of the same type or of buckets of the same type.

The lifetime of a rotor and buckets depends on the amount of physical load. Do not use rotors and buckets that exceed the maximum number of cycles.

The maximum number of cycles for rotors and buckets is given in the chapter “Rotor Specifications” on page B-1. The maximum number of cycles for buckets is marked on the buckets themselves.

Fiberlite rotors are not limited in cycles, but have a limited lifetime of 15 years.

Centrifuges with a GUI

The centrifuge counts cycles for a rotor type or a bucket type. You have to count the cycles of the rotors and buckets using your own method. The centrifuge can not detect the change or replacement of rotors of the same type or of buckets of the same type.

You can check the number of cycles for a rotor type on the user interface of the centrifuge. The rotor log saves the information of the used rotor types and bucket types.

Centrifuges with a LCD Control Panel

The centrifuge does not count cycles for a rotor type or a bucket type. You have to count the cycles of the rotors and buckets using your own method.

4. 3. Cleaning

Clean as follows:

1. Clean rotor, buckets and accessories outside of the centrifugation chamber.
2. Separate rotor, buckets, lids, adapters, tubes and O-rings to allow thorough cleaning.
3. Rinse rotor and all accessories with warm water and a neutral detergent that is suitable for use with the materials. If in doubt contact the manufacturer of the cleaning agent. Clean away the grease from the rotor trunnions (pivot point for swinging buckets).
4. Use a soft brush without metal bristles to remove stubborn residue.
5. Rinse rotor and all accessories with distilled water.
6. Place the rotors on a plastic grate with their cavities pointing down, to enable the cavities to fully drain and dry.
7. Dry all of the rotors and accessories after cleaning with a cloth or in a warm air cabinet at a maximum temperature of 50 °C. If drying boxes are used, the temperature must never exceed 50 °C. Higher temperatures could damage the material and shorten the lifetime of the parts.
8. Inspect the rotor and accessories for signs of damages (“Rotor and Accessories Inspection” on page 4-1).
9. After cleaning, treat the entire surface of aluminum parts including the cavities with corrosion protection oil (70009824).

Treat the bolts of swinging bucket rotors with bolt grease (75003786) if necessary.



CAUTION

Before using any cleaning methods, users should check with the manufacturer of the cleaning agents that the proposed method will not damage the equipment.

**CAUTION**

Drive and door lock can be damaged by entering liquids. Do not allow liquids, especially organic solvents, to get on the drive shaft, the drive bearings or the centrifuge door locks. Organic solvents break down the grease in the motor bearing. The drive shaft could lock up.

Touchscreen

1. Pull out the power supply plug.
2. Clean the touchscreen using a dry microfiber cloth.
3. If necessary moisten the microfiber cloth and wipe the touchscreen again.

Ventilation Grid

To clean the ventilation grid proceed as follows:

1. Pull out the power supply plug.
1. Remove the 2 screws of the ventilation grid ① on the right side of the centrifuge.
2. Remove the ventilation grid ② by pushing it downwards.
3. Use a vacuum cleaner to clean the ventilation grid and if necessary the condenser. Use a soft brush for detailed cleaning if needed.
4. Reinstall the ventilation grid.

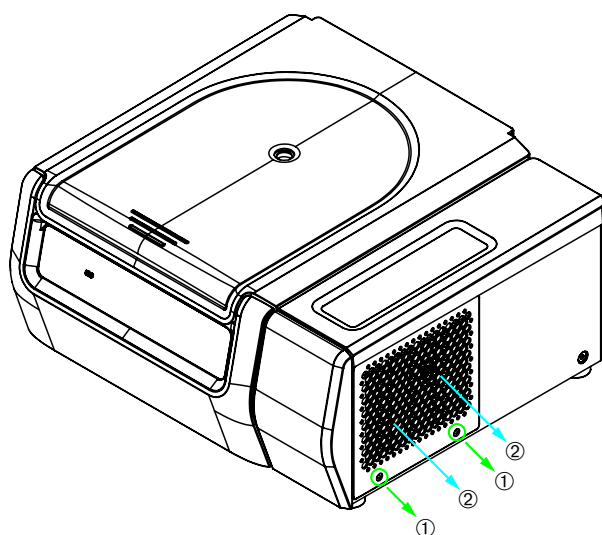

① Screws

② Ventilation Grid

Figure 4-1: Removing the ventilation grid

**CAUTION**

Cutting injuries can occur due to sharp metal. Do not touch the condenser with your hands when the ventilation grid is removed.

4. 4. Disinfection

You are responsible that the level of disinfection is achieved according to your requirements.

After disinfection:

1. Rinse the centrifuge and all affected accessories with water.
2. Allow to fully drain and dry.
3. After disinfecting, treat the entire surface of aluminum parts including the cavities with corrosion protection oil (70009824).

Treat the bolts of swinging bucket rotors with bolt grease (75003786) if necessary.



WARNING

Do not touch infected parts. Hazardous infection is possible when touching the contaminated rotor and centrifuge parts. Infectious material can get into the centrifuge when a tube breaks or as a result of spills. In case of contamination, make sure that no one is put at risk. Disinfect the affected parts immediately.



CAUTION

Equipment can be damaged by inappropriate disinfection methods or agents. Make sure that the disinfection agent or the method will not damage the equipment. In doubt contact the manufacturer of the disinfection agent. Observe the safety precautions and handling instructions for the disinfection agents used.

4. 5. Decontamination

You are responsible that the level of decontamination is achieved according to your requirements.

After decontamination:

1. Rinse the centrifuge and all affected accessories with water.
2. Allow to fully drain and dry.
3. After decontaminating, treat the entire surface of aluminum parts including the cavities with corrosion protection oil (70009824).

Treat the bolts of swinging bucket rotors with bolt grease (75003786) if necessary.



WARNING

Do not touch contaminated parts. Exposure to radiation is possible when touching the contaminated rotor and centrifuge parts. Contaminated material can get into the centrifuge when a tube breaks or as a result of spills. In case of contamination, make sure that no one is put at risk. Decontaminate the affected parts immediately.



CAUTION

Equipment can be damaged by inappropriate decontamination methods or agents. Make sure that the decontamination agent or the method will not damage the equipment. In doubt contact the manufacturer of the decontamination agent. Observe the safety precautions and handling instructions for the decontamination agents used.

4. 6. Autoclaving

Always disassemble all parts before autoclaving, e.g. lids need to be removed before autoclaving a bucket or rotor.

If not stated otherwise on the parts themselves, all parts can be autoclaved at 121 °C for 20 min. Refer to “Rotor Specifications” on page B-1 for details on rotors.

Make sure that the necessary sterility is achieved according to your requirements.

After autoclaving, treat the entire surface of aluminum parts including the cavities with corrosion protection oil (70009824).

Treat the bolts of swinging bucket rotors with bolt grease (75003786) if necessary.



CAUTION

Never exceed the permitted temperature and duration when autoclaving.

NOTICE

No chemical additives are permitted in the steam.

4. 7. Maintenance

Lifetime

The centrifuge is specified for a lifetime of 10 years. Decommissioning the centrifuge is suggested when this limit is reached.

The lifetime of rotors, buckets and lids is based on cycles and specified individually for each rotor in the chapter “Rotor Specifications” on page B-1. The lifetime of Fiberlite rotors is limited to 15 years. Other accessories are not limited by a specific lifetime and need only be replaced when damaged or worn.

Preventive Maintenance

In order to keep this product able to perform the intended applications reliably and safely, ongoing preventive maintenance is necessary in accordance with the following recommended schedule:

- The anti-vibration mounts of the motor suspension and motor cover (included in “Preventive Maintenance Kit (PM)” article no 50160419 for refrigerated or 50161150 for ventilated models) are suggested to be replaced at three-year intervals.
- The particle deflection seals for ventilated versions of the centrifuge (Art. No. 50159823) are suggested to be inspected annually and need to be replaced when damaged or exhibiting too much slack, but after 5 years at the latest.
- The gas spring of the centrifuge lid (GP4 Pro: article no 50154683 for refrigerated or 50159920 for ventilated models; GP1 Pro: article no 50154682) is suggested to be inspected annually and to be replaced when spring action deteriorates.
- The anti-vibration mounts (20038955) and the motor cover (20058551) need to be replaced every 3 years.
- For rotors and buckets mind the information in “Rotor and Accessories Inspection” on page 4-1.



CAUTION

Usage beyond these limits might affect the safety of the overall system.

NOTICE

In the worst case the centrifuge, the used accessories and the samples can be damaged.

NOTICE

Maintenance activities must be performed by Thermo Fisher Scientific authorized service technicians only.

Service

Thermo Fisher Scientific recommends having the centrifuge and accessories serviced once a year by an authorized service technician. The service technician checks the following:

- electrical equipment and connections
- suitability of set-up site
- centrifuge door lock and safety system
- rotor
- fixation of rotor and drive shaft of the centrifuge
- rubber gasket
- protective casing
- anti-vibration mounts

Before service, centrifuge and rotors should be thoroughly cleaned and decontaminated to ensure full and safe inspection can be completed.

Thermo Fisher Scientific offers inspection and service contracts for this work. Any necessary repairs are performed for free during the warranty period and afterwards for a charge. That is only valid if the centrifuge has only been maintained by an authorized Thermo Fisher Scientific service technician.

A validation of the centrifuge is recommended and can be ordered from customer service.

4. 8. Shipping

Before shipping the centrifuge:

- The centrifuge must be clean and decontaminated.
- You must confirm the decontamination with a decontamination certificate.



WARNING

Before shipping the centrifuge and accessories you must clean and, if necessary, disinfect or decontaminate the full system. If you are not sure, consult with Thermo Fisher Scientific customer service.

4. 9. Storage

- Before storing the centrifuge and the accessories it must be clean and if necessary disinfected and decontaminated.

Centrifuge, rotors, buckets and accessories have to be fully dry before storage.

- Keep the centrifuge in a clean, dry and dust-free location.
- Do not store the centrifuge in direct sunlight.



WARNING

When you remove the centrifuge and accessories from use, clean and if necessary disinfect or decontaminate the full system. If you are not sure speak to the Thermo Fisher Scientific customer service.

4. 10. Disposal

For the disposal of the centrifuge mind the regulations in your country. Contact the Thermo Fisher Scientific Customer Service for the disposal of the centrifuge. For contact information check the backpage of this manual or visit www.thermofisher.com/centrifuge

For the countries of the European Union the disposal is regulated by the European Union's Waste Electrical & Electronic Equipment (WEEE) Directive 2012/19/EC.

Mind the information on transport and shipping ("Shipping" on page 4-6 and "Transporting" on page 1-2).



WARNING

When removing the centrifuge and accessories from use for disposal you have to clean and if necessary disinfect or decontaminate the entire system. In doubt contact the Thermo Fisher Scientific customer service.

5. Troubleshooting

5.1. Mechanical Emergency Door Release

During a power failure, you will not be able to open the centrifuge lid with the regular electric lid release. A mechanical override is provided to allow sample recovery in the case of an emergency. However, this should be used only in emergencies and **after the rotor has come to a complete stop**.

Always wait until the rotor has come to a stop without braking. The brake does not work when there is no power. The braking process lasts much longer than usual.

Proceed as follows:

1. **Wait until the rotor has stopped.** This can take longer than 40 minutes.
2. Pull out the power supply plug.
3. On the back side of the housing there are two plastic plugs. You can pry these plugs out of the back plate with a screwdriver. Pull the release cord attached to trigger the mechanical lid release. The lid will open and the samples can be removed.

Refrigerated Benchtop Centrifuge

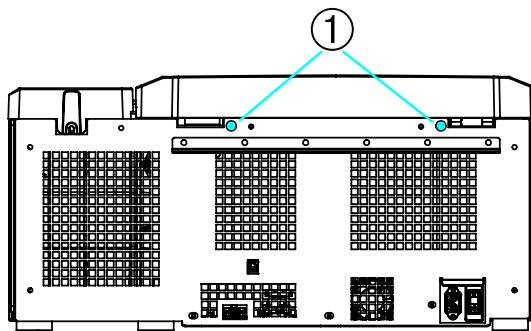

Ventilated Benchtop Centrifuge

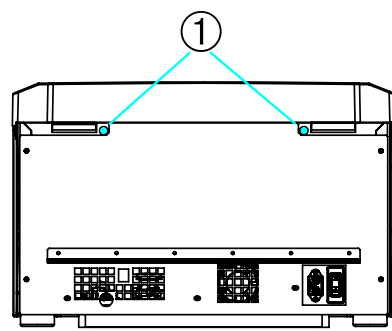

① Plastic plugs attached to the release cords

Floorstanding Centrifuge

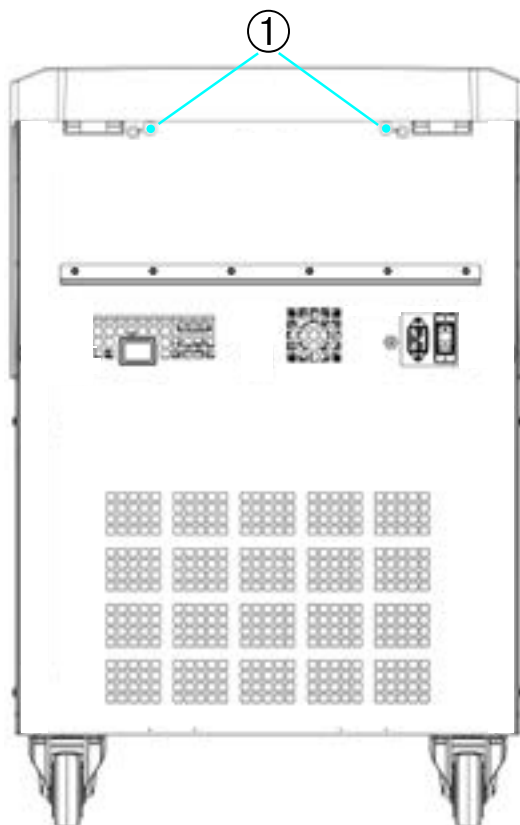

① Plastic plugs attached to the release cords

Figure 5-1: Emergency door release on the back side

NOTICE You need to pull both cords in order to unlock both locks.

4. Push the cord(s) back into the centrifuge and mount the plug(s).
5. Reconnect the centrifuge once the power has been restored.
6. Switch on the centrifuge.
7. Press the **OPEN** key to have the door locks operative again.

⚠ WARNING If you pull only one cord or you did not press the **OPEN** key to have the door locks operative again, the door might open while the rotor is still spinning.

WARNING

Serious injuries can occur if you touch a spinning rotor with your hands or tools. A rotor can still be spinning after a power failure occurs. Do not open the centrifuge before the rotor has stopped spinning. Do not touch a spinning rotor. Never use your hands or tools to stop a spinning rotor.

5.2. Ice Formation

Warm humid air in combination with a cold centrifugation chamber can lead to formation of ice. To remove the ice from the centrifugation chamber, proceed as follows:

1. Open the centrifuge door.
2. Remove the rotor. See “How to Install and Remove a Rotor” on page 2-5.
3. Let the ice melt.

NOTICE Do not use any sharp tools, aggressive liquids or fire to fasten the melting process. If necessary use warm water to speed up the melting process.

4. Remove the water from the centrifugation chamber.
5. Clean the centrifuge chamber. See “Maintenance and Care” on page 4-1.

5.3. Troubleshooting by Guide

NOTICE

If problems occur other than those listed in this table, the authorized customer service representative must be contacted.

Error Message	Description	Troubleshooting
Numbers not stated here	The centrifuge can not be operated. The run does not start or the centrifuge runs down without being braked.	Restart the centrifuge. If the error message still shows, contact a service technician.
14	Overtemperature detected.	Overheating in chamber. Check the function of the refrigeration unit. Clean the air inlet for the condenser. Restart the centrifuge. If the error message still shows, contact a service technician.
17–23	Rotor detection failed.	Make sure the rotor can be used in the centrifuge. Refer to “Rotor Program” on page A-8. Makes sure the rotor is properly installed. Refer to “How to Install and Remove a Rotor” on page 2-5. Restart the centrifuge. If the error message still shows, contact a service technician.
33	Overpressure in the refrigeration unit.	Clean the air inlet for the condenser. Restart the centrifuge. If the error message still shows, contact a service technician.

Error Message	Description	Troubleshooting
40	The centrifuge accelerates too slowly.	<p>Is the rotor properly installed?</p> <p>Check whether you have selected the right bucket.</p> <p>Is it easy to turn the rotor when the lid is open?</p> <p>Does the rotor rub against the device?</p> <p>Restart the centrifuge.</p> <p>If the error message still shows, contact a service technician.</p>
97	Mechanical emergency door release.	<p>Close the centrifuge lid.</p> <p>Do not touch a spinning rotor. Never use your hands or tools to stop a spinning rotor.</p> <p>Restart the centrifuge.</p> <p>If the error message still shows, contact a service technician.</p>
98	Imbalance detected.	<p>Check the loading of the rotor.</p> <p>Check the lubrication of the trunnion bolts of the rotor body if a swinging bucket rotor is used.</p> <p>Restart the centrifuge.</p> <p>If the error message still shows, contact a service technician.</p>

Table 5-1: Error Messages

5. 4. Information for the Customer Service

If you need to contact customer service, please provide the order no. and the serial no. of your device. This information can be found on the type plate.

To identify the software version on a centrifuge with a LCD control panel, proceed as follows:

1. Hold down any of the keys and then switch on the centrifuge.
You enter the system menu.
2. Press the **START** key.
3. Press and hold the **ENTER** key, until the following message is displayed:
Software ID: xxxxxxx

To identify the software version on a centrifuge with a GUI, proceed as follows:

Press the **Files and Info** button on the navigation bar. Product version information is displayed.

A. Technical Specifications

A. 1. SL Plus Series

Model	SL1 Plus SL1 Plus-MD	SL1R Plus SL1R Plus-MD
Environmental Conditions	Use in interior spaces only. Altitudes of up to 3000 m above sea level. Max. relative humidity 80 % up to 31 °C; decreasing linearly to 50 % relative humidity at 40 °C	Use in interior spaces only. Altitudes of up to 3000 m above sea level. Max. relative humidity 80 % up to 31 °C; decreasing linearly to 50 % relative humidity at 40 °C
Environmental Conditions during Storage and Shipping	Temperature: -10 °C to 55 °C Humidity: 15 % to 85 %	Temperature: -10 °C to 55 °C Humidity: 15 % to 85 %
Permissible Ambient Temperature during Operation	+2 °C to +35 °C	+2 °C to +35 °C
Average Heat Dissipation 100–240 V 120 V 220-230 V	0.65 kW/h - -	- 1.0 kW/h 1.0 kW/h
Overvoltage Category	II	II
Pollution Degree	2	2
IP	20	20
Running Time	99 h, 59 min (increments of 1 minutes)	99 h, 59 min (increments of 1 minutes)
Maximum Speed n_{max}	15200 rpm (depending on the rotor)	15200 rpm (depending on the rotor)
Minimum Speed n_{min}	300 rpm	300 rpm
Maximum RCF Value at n_{max}	25830 x g (depending on the rotor)	25830 x g (depending on the rotor)
Noise Level at Maximum Speed ^{1, 2}	< 73 dB (A)	< 68 dB (A)
Maximum Kinetic Energy 100-240 V 120 V 220-230 V	41 kJ - -	41 kJ 41 kJ 41 kJ
Temperature Setting Range	-	-10 °C to +40 °C
Dimensions Height (lid open / lid closed) Table top height Width Depth (with mains connection)	855 mm / 364 mm 320 mm 445 mm 660 mm	855 mm / 364 mm 320 mm 625 mm 660 mm
Weight ³ 100 V-240 V 120 V 220-230 V	61 kg - -	- 92 kg 94 kg

¹ 1 m in front of the instrument at 1.6 m height.

² Measured with Fiberlite F15-8 x 50cy at 14500 rpm, cooling set to -10 °C (only refrigerated).

³ Without rotor.

Table A-1: Technical Data SL Plus Series Centrifuges

Model	SL4 Plus SL4 Plus-MD	SL4R Plus SL4R Plus-MD
Environmental Conditions	Use in interior spaces only. Altitudes of up to 3000 m above sea level. Max. relative humidity 80 % up to 31 °C; decreasing linearly to 50 % relative humidity at 40 °C	Use in interior spaces only. Altitudes of up to 3000 m above sea level. Max. relative humidity 80 % up to 31 °C; decreasing linearly to 50 % relative humidity at 40 °C
Environmental Conditions during Storage and Shipping	Temperature: -10 °C to 55 °C Humidity: 15 % to 85 %	Temperature: -10 °C to 55 °C Humidity: 15 % to 85 %
Permissible Ambient Temperature during Operation	+2 °C to +35 °C	+2 °C to +35 °C
Average Heat Dissipation 120 V 220 V 208–240 V 220–240 V / 230 V	1.0 kW/h - 1.2 kW/h -	1.1 kW/h 1.6 kW/h - 1.6 kW/h
Overvoltage Category	II	II
Pollution Degree	2	2
IP	20	20
Running Time	99 h, 59 min (increments of 1 minutes)	99 h, 59 min (increments of 1 minutes)
Maximum Speed n_{max}	15200 rpm (depending on the rotor)	15200 rpm (depending on the rotor)
Minimum Speed n_{min}	300 rpm	300 rpm
Maximum RCF Value at n_{max}	25830 x g (depending on the rotor)	25830 x g (depending on the rotor)
Noise Level at Maximum Speed ^{1, 2}	< 68 dB (A)	< 63 dB (A)
Maximum Kinetic Energy 120 V 220 V 208–240 V 220–240 V / 230 V	51.7 kJ - 62.5 kJ -	51.7 kJ 62.5 kJ - 62.5 kJ
Temperature Setting Range	-	-10 °C to +40 °C
Dimensions Height (lid open / lid closed) Table top height Width Depth (with mains connection)	861 mm / 362 mm 325 mm 566 mm 690 mm	860 mm / 361 mm 325 mm 746 mm 690 mm
Weight ³ 120 V 220 V 208–240 V 220–240 V / 230 V	89 kg - 89 kg -	117 kg 125 kg - 125 kg

¹ 1 m in front of the instrument at 1.6 m height.

² Measured with Fiberlite F15-8 x 50cy at 14500 rpm, cooling set to -10 °C (only refrigerated).

³ Without rotor.

Table A-2: Technical Data SL Plus Series Centrifuges

Model	SL4F Plus SL4F Plus-MD	SL4RF Plus SL4RF Plus-MD
Environmental Conditions	Use in interior spaces only. Altitudes of up to 3000 m above sea level. Max. relative humidity 80 % up to 31 °C; decreasing linearly to 50 % relative humidity at 40 °C	Use in interior spaces only. Altitudes of up to 3000 m above sea level. Max. relative humidity 80 % up to 31 °C; decreasing linearly to 50 % relative humidity at 40 °C
Environmental Conditions during Storage and Shipping	Temperature: -10 °C to 55 °C Humidity: 15 % to 85 %	Temperature: -10 °C to 55 °C Humidity: 15 % to 85 %
Permissible Ambient Temperature during Operation	+2 °C to +35 °C	+2 °C to +35 °C
Average Heat Dissipation		
120 V	-	-
220 V	-	-
208–240 V	1.2 kW/h	-
220–240 V / 230 V	-	1.6 kW/h
Overvoltage Category	II	II
Pollution Degree	2	2
IP	20	20
Running Time	99 h, 59 min (increments of 1 minutes)	99 h, 59 min (increments of 1 minutes)
Maximum Speed n_{max}	15200 rpm (depending on the rotor)	15200 rpm (depending on the rotor)
Minimum Speed n_{min}	300 rpm	300 rpm
Maximum RCF Value at n_{max}	25830 x g (depending on the rotor)	25830 x g (depending on the rotor)
Noise Level at Maximum Speed ^{1,2}	< 70 dB (A)	< 69 dB (A)
Maximum Kinetic Energy		
120 V	-	-
220 V	-	-
208–240 V	62.5 kJ	-
220–240 V / 230 V	-	62.5 kJ
Temperature Setting Range	-	-10 °C to +40 °C
Dimensions		
Height (lid open / lid closed)	1350 mm / 835 mm	1350 mm / 835 mm
Table top height	800 mm	800 mm
Width	566 mm	566 mm
Depth (with mains connection)	690 mm	690 mm
Weight ³		
120 V	-	-
220 V	-	-
208–240 V	152 kg	-
220–240 V / 230 V	-	145 kg

¹ 1 m in front of the instrument at 1.6 m height.

² Measured with Fiberlite F15-8 x 50cy at 14500 rpm, cooling set to -10 °C (only refrigerated).

³ Without rotor.

Table A-3: Technical Data SL Plus Series Centrifuges

A. 2. Directives, Standards and Guidelines

Centrifuge	Region	Directive	Standard
Thermo Scientific SL1 Plus SL1R Plus SL4 Plus SL4R Plus SL4F Plus SL4RF Plus	<p>Europe</p> <p><u>Refrigerated</u> 220-240 V, 50 Hz / 230 V, 60 Hz</p> <p><u>Refrigerated</u> 220-230 Hz, 50 / 60 Hz</p> <p><u>Ventilated</u> 208-240 V, 50 / 60 Hz</p> <p><u>Ventilated</u> 100-240 V, 50 / 60 Hz</p>	<p>2006/42/EC Machinery</p> <p>2014/35/EU Low Voltage (Protective Goals)</p> <p>2014/30/EC Electromagnetic Compatibility (EMC)</p> <p>2011/65/EC RoHS Directive on the Restriction of the use of certain Hazardous Substances in electrical and electronic equipment</p>	<p>EN 61010-1 3rd Edition</p> <p>EN 61010-2-020 3rd Edition</p> <p>EN 61326-1 Class B</p> <p>EN ISO 13485</p> <p>EN ISO 14971</p> <p>ISO 9001</p>
	<p>USA & Canada</p> <p><u>Refrigerated</u> 220-240 V, 50 Hz / 230 V, 60 Hz</p> <p><u>Refrigerated / Ventilated</u> 120 V, 60 Hz</p> <p><u>Ventilated</u> 208-240 V, 50 / 60 Hz</p> <p><u>Ventilated</u> 100-240 V, 50 / 60 Hz</p>		<p>ANSI/UL 61010-1 3rd Edition</p> <p>UL 61010-2-020 3rd Edition</p> <p>FCC Part 15</p> <p>EN ISO 14971</p> <p>EN ISO 13485</p> <p>ISO 9001</p>
	<p>Japan</p> <p><u>Ventilated</u> 100-240 V, 50 / 60 Hz</p> <p>South Korea</p> <p><u>Refrigerated</u> 220 V, 60 Hz</p> <p>China</p> <p><u>Refrigerated</u> 220-240 V, 50 Hz / 230 V, 60 Hz</p> <p><u>Ventilated</u> 208-240 V, 50 / 60 Hz</p> <p><u>Ventilated</u> 100-240 V, 50 / 60 Hz</p>		<p>IEC 61010-1 3rd Edition</p> <p>IEC 61010-2-020 3rd Edition</p> <p>IEC 61326-1 Class B</p> <p>EN ISO 14971</p> <p>EN ISO 13485</p> <p>ISO 9001</p>

Table A-4: Directives and Standards for SL Plus Series Centrifuges

NOTE This equipment has been tested and found to comply with the limits for a Class A digital device, pursuant to part 15 of the FCC Rules. These limits are designed to provide reasonable protection against harmful interference when the equipment is operated in a commercial environment. This equipment generates, uses, and can radiate radio frequency energy and, if not installed and used in accordance with the instruction manual, may cause harmful interference to radio communications. Operation of this equipment in a residential area is likely to cause harmful interference in which case the user will be required to correct the interference at his own expense.

Centrifuge	Region	Directive	Standard
Thermo Scientific SL1 Plus-MD SL1R Plus-MD SL4 Plus-MD SL4R Plus-MD SL4F Plus-MD SL4RF Plus-MD	Europe <u>Refrigerated</u> 220–240 V, 50 Hz / 230 V, 60 Hz <u>Refrigerated</u> 220-230 Hz, 50 / 60 Hz <u>Ventilated</u> 208–240 V, 50 / 60 Hz <u>Ventilated</u> 100-240 V, 50 / 60 Hz	98/79/EC In Vitro Diagnostics 2006/42/EC Machinery 2014/35/EU Low Voltage (Protective Goals) 2014/30/EC Electromagnetic Compatibility (EMC) 2011/65/EC RoHS Directive on the Restriction of the use of certain Hazardous Substances in electrical and electronic equipment	EN 61010-1 3rd Edition EN 61010-2-020 3rd Edition EN 61010-2-101 3rd Edition EN 61326-2-6 EN 61326-1 Class B EN ISO 13485 EN ISO 14971 ISO 9001
	USA & Canada <u>Refrigerated</u> 220–240 V, 50 Hz / 230 V, 60 Hz <u>Refrigerated / Ventilated</u> 120 V, 60 Hz <u>Ventilated</u> 208–240 V, 50 / 60 Hz <u>Ventilated</u> 100-240 V, 50 / 60 Hz	FDA listed Product code JQC centrifuges for clinical use Device class 1	ANSI/UL 61010-1 3rd Edition UL 61010-2-020 3rd Edition UL 61010-2-101 3rd Edition FCC Part 15 EN ISO 14971 EN ISO 13485 ISO 9001
	Japan <u>Ventilated</u> 100-240 V, 50 / 60 Hz South Korea <u>Refrigerated</u> 220 V, 60 Hz China <u>Refrigerated</u> 220–240 V, 50 Hz / 230 V, 60 Hz <u>Ventilated</u> 208–240 V, 50 / 60 Hz <u>Ventilated</u> 100-240 V, 50 / 60 Hz		IEC 61010-1 3rd Edition IEC 61010-2-020 3rd Edition IEC 61010-2-101 3rd Edition IEC 61326-2-6 IEC 61326-1 Class B EN ISO 14971 EN ISO 13485 ISO 9001

Table A-5: Directives and Standards for SL Plus-MD Series Centrifuges

NOTE This equipment has been tested and found to comply with the limits for a Class A digital device, pursuant to part 15 of the FCC Rules. These limits are designed to provide reasonable protection against harmful interference when the equipment is operated in a commercial environment. This equipment generates, uses, and can radiate radio frequency energy and, if not installed and used in accordance with the instruction manual, may cause harmful interference to radio communications. Operation of this equipment in a residential area is likely to cause harmful interference in which case the user will be required to correct the interference at his own expense.

A. 3. Refrigerants

Article No.	Centrifuge	Refrigerant	Quantity	Pressure	GWP	CO ₂ e
75009630	SL1R Plus (220-230 V)	R-134a	0.28 kg	21 bar	1430	0.4 t
75009030	SL1R Plus-MD (220-230 V)	R-134a	0.28 kg	21 bar	1430	0.4 t
75009031	SL1R Plus-MD (120 V)	R-134a	0.38 kg	21 bar	1430	0.54 t
75009927	SL4R Plus (220-240 V / 230 V)	R-134a	0.43 kg	31 bar	1430	0.61 t
75009827	SL4R Plus (220 V)	R-134a	0.43 kg	31 bar	1430	0.61 t
75009527	SL4R Plus-MD (220-240 V / 230 V)	R-134a	0.43 kg	31 bar	1430	0.61 t
75009528	SL4R Plus-MD (120 V)	R-134a	0.54 kg	21 bar	1430	0.77 t
75009627	SL4R Plus-MD (220 V)	R-134a	0.43 kg	31 bar	1430	0.61 t
75009953	SL4RF Plus (220-240 V / 230 V)	R-134a	0.45 kg	21 bar	1430	0.64 t
75009973	SL4RF Plus-MD (220-240 V / 230 V)	R-134a	0.45 kg	21 bar	1430	0.64 t

Contains fluorinated greenhouse gases in a hermetically sealed system.

Table A-6: Refrigerants Used for SL Plus Series

A. 4. Mains Supply

The following table contains an overview of the electrical connection data for the SL Plus Series Centrifuges. This data is to be taken into consideration when selecting the mains connection socket.

Art. No.	Centrifuge	Mains Voltage (V)	Frequency (Hz)	Rated Current (A)	Power Consumption (W)	Building Fuse (AT)	Equipment Fuse (AT)
75009600	SL1 Plus	100-240	50 / 60	8.5	850	15	15 USA 16 Europe
75009630	SL1R Plus	220-230	50 / 60	6.5	1350	15	16
75009000	SL1 Plus-MD	100-240	50 / 60	8.5	850	15	15 USA 16 Europe
75009030	SL1R Plus-MD	220-230	50 / 60	6.5	1350	15	16
75009031	SL1R Plus-MD	120	60	11	1350	15	15
75009912	SL4 Plus	208-240	50 / 60	7.5	1600	15	16
75009927	SL4R Plus	220-240	50	8.5	1850	16	15
		230	60	8.5	1850	15	16
75009827	SL4R Plus	220	60	8.5	1850	15	16
75009512	SL4 Plus-MD	208-240	50 / 60	7.5	1600	15	16
75009513	SL4 Plus-MD	120	50 / 60	10.5	1300	15	15
75009527	SL4R Plus-MD	220-240	50	8.5	1850	15	16
		230	60	8.5	1850		
75009627	SL4R Plus-MD	220	60	8.5	1850	15	16
75009528	SL4R Plus-MD	120	60	12	1400	15	15
75009951	SL4F Plus	208-240	50 / 60	7.5	1600	15	16
75009953	SL4RF Plus	220-240	50	8.5	1850	15	16
		230	60	8.5	1850		
75009971	SL4F Plus-MD	208-240	50 / 60	7.5	1600	15	16
75009973	SL4RF Plus-MD	220-240	50	8.5	1850	15	16
		230	60	8.5	1850		

Table A-7: Electrical Connection Data for SL Plus Series

A. 5. Rotor Program

For more details on rotors and accessories refer to “Rotor Specifications” on page B-1.

A. 5. 1. Rotors for Laboratory Use and In Vitro Diagnostic (IVD) Centrifuges

Thermo Scientific - Rotor Name	SL1 Plus / SL1R Plus / SL1 Plus-MD / SL1R Plus-MD	SL4 Plus / SL4R Plus / SL4 Plus-MD / SL4R Plus-MD SL4F Plus / SL4RF Plus / SL4F Plus-MD / SL4RF Plus-MD
TX-200 (75003658)	✓	✗
TX-400 (75003181)	✓	✗
TX-750 (75003180)	✗	✓
TX-1000 (75003017)	✗	✓
H-FLEX 1 (75003300)	✓	✗
H-FLEX HS4 (75003330)	✗	✓
HIGHPlate 6000 (75003606)	✗	✗
M-20 Microplate (75003624)	✓	✓
BIOShield 720 (75003183)	✓	✗
BIOShield 1000A (75003182)	✗	✓
CLINIConic (75003623)	✓	✗
8 x 50 ml Sealed (75003694)	✓	✗
HIGHConic II (75003620)	✓	✓
Microliter 30 x 2 (75003652)	✓	✓
Microliter 48 x 2 (75003602)	✓	✓
MicroClick 30 x 2 (75005719)	✓	✓
MicroClick 18 x 5 (75005765)	✓	✓
Fiberlite F13-14 x 50cy (75003661)	✗	✗
Fiberlite F14-6 x 250 LE (75003662)	✗	✗
Fiberlite F15-6 x 100y (75003698)	✓	✓
Fiberlite F15-8 x 50cy (75003663)	✗	✗
Fiberlite F21-48 x 2 (75003664)	✓	✓
Fiberlite H3-LV (75003665)	✗	✗
Fiberlite F10-6 x 100 LEX (75003340)	✓	✓

Table A-8: Rotor Program - General and IVD Use

B. Rotor Specifications

This section lists the rotors and their accessories.

For more details on adapters and accessories refer to the separate rotor subchapters in this chapter.



B. 1. TX-200

B. 1. 1. Items Supplied

Article No.	Item	Quantity
75003658	TX-200 Rotor	1
50157859	Rotor safety information	1
75003786	Bolt grease	1
50158588	GP rotors information card	1

B. 1. 2. Technical Data

General Technical Data	
Weight (empty)	2.5 kg
Maximum Permissible Load	4 x 275 g
Max. Cycle Number	82000
Radius max. / min.	165 / 64 mm
Angle	90°
Aerosol-tight	Yes
Max. Autoclaving Temperature	121 °C

Performance data of the compatible ventilated 1 L centrifuges

SL1 Plus / SL1 Plus-MD	
Centrifuge Voltage	100-240 V, 50/60 Hz
Maximum Speed n_{max}	5500 rpm
Maximum RCF-Value at n_{max}	5580 x g
K-Factor at n_{max}	7921
Acceleration / Braking Time	20 s / 30 s
Temperature increase in the sample after 1 h of continuous run, tolerance $\pm 2K$	13 °C

Performance data of the compatible refrigerated 1 L centrifuges

SL1R Plus / SL1R Plus-MD		
Centrifuge Voltage	220-230 V, 50/60 Hz	120 V, 60 Hz
Maximum Speed n_{max}	5500 rpm	5500 rpm
Maximum RCF-Value at n_{max}	5580 x g	5580 x g
K-Factor at n_{max}	7921	7921
Acceleration / Braking Time	20 s / 30 s	20 s / 30 s
Maximum Speed at 4 °C	5500 rpm	5500 rpm
Sample Temperature at max. Speed (ambient temp. at 23 °C, run time 2 h), tolerance $\pm 2 K$	1 °C	6 °C



B. 1. 3. Accessories

Article No.	Description
Accessories	
75003659	TX-200 round buckets (4x)
75003660	TX-200 round ClickSeal biocontainment lids (4x)
75003687	Replacement TX-200 O-rings for lids (4x)
75003800	180 ml bio-bottle - polypropylene (12x)
Adapters used for Laboratory Use	
75003801	100 ml round bottom open-top tube
75003802	50 ml DIN round bottom tube
75003815	50 ml round bottom tube
75003805	25 ml DIN round/flat bottom tube
75003806	20 ml round bottom tube
75003810	5/7 ml round bottom open-top tube
75003811	3/5 ml RIA or round bottom tube
Adapters used for IVD	
75003803	50 ml conical or skirted tube
75003771	15 ml conical tube
75003809	15 ml blood collection tube
75003807	14 ml conical urine tube
75003808	10 ml blood collection tube
75003804	30 ml Sterilin Universal tube
75003812	1.5/2 ml Microtube
75003785	5/7 ml or 4.5/6 ml blood collection tube

B. 1. 4. Biocontainment Certificate

Centre of Emergency Preparedness and Response
Health Protection Agency
Porton Down
Salisbury
Wiltshire SP14 3QD
United Kingdom



Certificate of Containment Testing

**Containment testing
of Thermo Scientific swing out bucket
rotor 75003658 and buckets 75003659**

Report No. 77-08 G

Report prepared for: Thermo Fisher
Issue Date: 1st June 2009

Test Summary

A Thermo Scientific centrifuge bucket 75003659 with aerosol tight lid (Max speed: 5,500 rpm) was supplied by Thermo Fisher and containment tested at 5,500 rpm using the method described in Annex AA of EN 61010-2-025. The rotor was shown to contain a spill when tested in duplicate.

Report Written By:  Report Authorised By: 



B. 2. TX-400

B. 2. 1. Items Supplied

Article No.	Item	Quantity
75003629	TX-400 rotor	1
50157859	Rotor safety information	1
75003786	Bolt grease	1
50158588	GP rotors information card	1

B. 2. 2. Technical Data

General Technical Data	
Weight (empty)	4.1 kg
Maximum Permissible Load	4 x 570 g
Max. Cycle Number	50 000
Radius max. / min.	168 / 68 mm
Angle	90°
Aerosol-tight	Yes
Max. Autoclaving Temperature	121 °C

Performance data of the compatible ventilated 1 L centrifuges

SL1 Plus / SL1 Plus-MD	
Centrifuge Voltage	100-240 V, 50/60 Hz
Maximum Speed n_{max}	5 000 rpm
Maximum RCF-Value at n_{max}	4 696 x g
K-Factor at n_{max}	9 153
Acceleration / Braking Time	25 s / 35 s
Temperature increase in the sample after 1 h of continuous run, tolerance $\pm 2K$	13 °C

Performance data of the compatible refrigerated 1 L centrifuges

SL1R Plus / SL1R Plus-MD		
Centrifuge Voltage	220-230 V, 50/60 Hz	120 V, 60 Hz
Maximum Speed n_{max}	5 000 rpm	5 000 rpm
Maximum RCF-Value at n_{max}	4 696 x g	4 696 x g
K-Factor at n_{max}	9 153	9 153
Acceleration / Braking Time	25 s / 35 s	30 s / 35 s
Maximum Speed at 4 °C	5 000 rpm	5 000 rpm
Sample Temperature at max. Speed (ambient temp. at 23 °C, run time 2 h), tolerance $\pm 2 K$	-3 °C	2 °C



B. 2. 3. Accessories

Article No.	Description
Accessories	
75003181	TX-400 rotor cross
75003655	TX-400 round buckets (4x)
75003656	TX-400 round ClickSeal biocontainment lids (4x)
75003657	Replacement TX-400 o-rings for lids (4x)
75007585	400 ml bio-bottle - polypropylene (12x)
Adapters used for Laboratory Use	
75003788	250 ml Thermo Scientific Nalgene™ bottle; 200 ml Thermo Scientific Nunc conical bottle (requires Nunc #377585); 225 ml/175 ml BD Falcon conical bottle (requires BD #352090)
75003708	100 ml round bottom open-top tube
75003707	50 ml DIN round bottom tube
75003799	50 ml Nalgene™ Oak Ridge tube
75003703	30/25 ml DIN round/flat bottom tube
75003704	15 ml round bottom tube (Sarstedt)
75003793	3 ml RIA or round bottom tube (without cap)
Adapters used for IVD	
75003683	50 ml conical tube
75003682	15 ml conical tube
75003794	15 ml blood collection tube (17 x 125 mm)
75003798	14 ml round or conical urine tube
75003681	10 ml blood collection (16 x 100 mm)
75003706	30 ml Sterilin Universal tube
75003680	5/7 ml blood collection tube (13 x 75-100 mm)
75003700	1.5/2 ml Microtube
75003825	4.5/6 ml blood collection tube (Greiner)

B. 2. 4. Biocontainment Certificate

Centre of Emergency Preparedness and Response
Health Protection Agency
Porton Down
Salisbury
Wiltshire SP4 6UE
United Kingdom



Certificate of Containment Testing

Containment testing of Thermo Scientific swing out bucket rotor 75003629 and buckets 75003655

Report No. 77-08-E

Report prepared for: Thermo Fisher
Issue Date: 1st June 2009

Test Summary

A Thermo Scientific centrifuge bucket 75003629 with aerosol tight lid (Max speed 5,000 rpm) was supplied by Thermo Fisher and containment tested at 5,000 rpm using the method described in Annex AA of EN 61010-2-020. The rotor was shown to contain a spill when tested in triplicate.

Report Written By

Report Authorised By



B. 3. TX-750

B. 3. 1. Items Supplied

Article No.	Item	Quantity
75003180	TX-750 rotor	1
50157859	Rotor safety information	1
75003786	Bolt grease	1
50158588	GP rotors information card	1

Performance data of the compatible ventilated 4 L centrifuges

SL4 Plus / SL4 Plus-MD SL4F Plus / SL4F Plus-MD		
Centrifuge Voltage	208-240 V, 50/60 Hz 220-240 V, 50 Hz 230 V, 60 Hz	120 V, 60 Hz
Maximum Speed n_{max}	4700 rpm	4700 rpm
Maximum RCF-Value at n_{max}	4816 x g	4816 x g
K-Factor at n_{max}	9783	9783
Acceleration / Braking Time	40 s / 45 s	55 s / 45 s
Temperature increase in the sample after 1 h of continuous run, tolerance $\pm 2K$	13 °C	13 °C

B. 3. 2. Technical Data (Round Buckets)

General Technical Data	
Weight (empty)	7.4 kg
Maximum Permissible Load	4 x 800 g
Max. Cycle Number	
Rotor Cross	120000
Bucket	70000
Radius max. / min.	195 mm / 83 mm
Angle	90°
Aerosol-tight	Optional
Max. Autoclaving Temperature	121 °C
Not Autoclavable Parts	O-ring 75003610

Performance data of the compatible refrigerated 4 L centrifuges

SL4R Plus / SL4R Plus-MD SL4RF Plus / SL4RF Plus-MD		
Centrifuge Voltage	220 V, 60 Hz 220-240 V, 50 Hz 230 V, 60 Hz	120 V, 60 Hz
Maximum Speed n_{max}	4700 rpm	4700 rpm
Maximum RCF-Value at n_{max}	4816 x g	4816 x g
K-Factor at n_{max}	9783	9783
Acceleration / Braking Time	40 s / 45 s	50 s / 50 s
Maximum Speed at 4 °C	4700 rpm	4400 rpm
Sample Temperature at max. Speed (ambient temp. at 23 °C, run time 2 h), tolerance $\pm 2 K$	1 °C	11 °C



B. 3. 3. Technical Data (Rectangular Buckets)

General Technical Data	
Weight (empty)	6.8 kg
Maximum Permissible Load	4 x 750 g
Max. Cycle Number	
Rotor Cross	120000
Bucket	100000
Radius max. / min.	195 mm / 89 mm
Angle	90°
Aerosol-tight	Optional
Max. Autoclaving Temperature	121 °C
Not Autoclavable Parts	O-ring 75003610

Performance data of the compatible ventilated 4 L centrifuges

SL4 Plus / SL4 Plus-MD SL4F Plus / SL4F Plus-MD		
Centrifuge Voltage	208-240 V, 50/60 Hz 220-240 V, 50 Hz 230 V, 60 Hz	120 V, 60 Hz
Maximum Speed n_{max}	4500 rpm	4300 rpm
Maximum RCF-Value at n_{max}	4415 x g	4031 x g
K-Factor at n_{max}	9800	10732
Acceleration / Braking Time	40 s / 40 s	20 s / 40 s
Temperature increase in the sample after 1 h of continuous run, tolerance $\pm 2K$	13 °C	10 °C

Performance data of the compatible refrigerated 4 L centrifuges

SL4R Plus / SL4R Plus-MD SL4RF Plus / SL4RF Plus-MD		
Centrifuge Voltage	220 V, 60 Hz 220-240 V, 50 Hz 230 V, 60 Hz	120 V, 60 Hz
Maximum Speed n_{max}	4700 rpm	4300 rpm
Maximum RCF-Value at n_{max}	4816 x g	4031 x g
K-Factor at n_{max}	8983	10732
Acceleration / Braking Time	40 s / 45 s	40 s / 40 s
Maximum Speed at 4 °C	4600 rpm	3800 rpm
Sample Temperature at max. Speed (ambient temp. at 23 °C, run time 2 h), tolerance $\pm 2 K$	7 °C	10 °C



B. 3. 4. Technical Data (Microplate Carriers)

General Technical Data	
Weight (empty)	7.3 kg
Maximum Permissible Load	4 x 500 g
Max. Cycle Number	
Rotor Cross	120 000
Bucket	120 000
Radius max. / min.	155 mm / 99 mm
Angle	90°
Aerosol-tight	No
Max. Autoclaving Temperature	121 °C

Performance data of the compatible ventilated 4 L centrifuges

SL4 Plus / SL4 Plus-MD SL4F Plus / SL4F Plus-MD		
Centrifuge Voltage	208-240 V, 50/60 Hz 220-240 V, 50 Hz 230 V, 60 Hz	120 V, 60 Hz
Maximum Speed n_{max}	4 700 rpm	4 700 rpm
Maximum RCF-Value at n_{max}	3 828 x g	3 828 x g
K-Factor at n_{max}	5 135	5 135
Acceleration / Braking Time	35 s / 40 s	45 s / 40 s
Temperature increase in the sample after 1 h of continuous run, tolerance $\pm 2K$	10 °C	10 °C

Performance data of the compatible refrigerated 4 L centrifuges

SL4R Plus / SL4R Plus-MD SL4RF Plus / SL4RF Plus-MD		
Centrifuge Voltage	220 V, 60 Hz 220-240 V, 50 Hz 230 V, 60 Hz	120 V, 60 Hz
Maximum Speed n_{max}	4 700 rpm	4 700 rpm
Maximum RCF-Value at n_{max}	3 828 x g	3 828 x g
K-Factor at n_{max}	5 135	5 135
Acceleration / Braking Time	30 s / 45 s	40 s / 45 s
Maximum Speed at 4 °C	4 700 rpm	4 400 rpm
Sample Temperature at max. Speed (ambient temp. at 23 °C, run time 2 h), tolerance $\pm 2 K$	<0 °C	11 °C

B. 3. 5. Accessories



TX-750 (round buckets)

Article No.	Description
Accessories	
75003180	TX-750 rotor cross
75003608	TX-750 round buckets (4x) *
75003609	TX-750 round ClickSeal biocontainment lids (4x)
75003610	Replacement TX-750 round O-rings for lids (4x)
75006443	750 ml Bio-Bottle - Polypropylene (1 each)
75003795	Microplate Carriers and T-75 Flask (includes tray and pads) (2x)
75003617	Microplate Carriers and T-75 Flask (includes tray and pads) (4x)
Adapters used for Laboratory Use	
75003792	250 ml Corning conical bottle (unsealed buckets only)
75003710	250 ml Nalgene bottle
75003710	225 ml/175 ml BD Falcon conical bottle (requires BD #352090) (open buckets only)
75003710	200 ml Nunc conical bottle (open buckets only) (requires Nunc #377585)
75003710	175 ml Nalgene conical bottle (requires Nalgene #DS3126-0175) (open buckets only)
75003713	100 ml round bottom open-top tube
75003715	50 ml Nalgene Oak Ridge tube
75003724	5 ml RIA or round bottom tube (with out cap)
75003732	5/7 ml round bottom tube (without cap) with decanting aid
75008383	T-75 Nunc Easy Flask
75008384	T-25 Nunc Easy Flask
Adapters used for IVD	
75003714	50 ml conical tube (includes sealing vessel) can be combined with ClickSeal lids
75003638	50 ml conical tube
75003824 (New number: 75006533 x 4)	50 ml conical or skirted tube
75003716	30 ml Sterilin Universal tube
75003639	15 ml conical tube
75003719	15 ml blood collection tube (17 x 125 mm) (inner circle only)
75003719	10 ml blood collection (16 x 100 mm) or 15 ml Corex/Kimble tube
75003718	14 ml round or conical urine tube
75003723	5/7 ml or 4.5/6 ml blood collection tube (13 x 75-100 mm)
75003733	1.5/2 ml Microtube

TX-750 (rectangular buckets)

Article No.	Description
Accessories	
75003180	TX-750 rotor cross
75003614	TX-750 rectangular Buckets (4x)
75003615	TX-750 rectangular ClickSeal biocontainment lids (4x)
75003616	Replacement TX-750 rectangular O-rings for lids (4x)
Adapters used for Laboratory Use	
75003737	250 ml flat bottom bottle
75003738	150 ml round bottom open-top tube
75003742	100 ml round bottom open-top tube
75003749	50 ml round bottom tube
75003750	45 ml flat/round tube
75003756	25 ml DIN round bottom tube
75003758	14 ml flanged round bottom tube
75003769	5/7 ml round bottom tube (13 x 75-100 mm)
Adapters used for IVD	
75003685	50 ml conical tube
75003684	15 ml conical tube
75003759	14 ml round or conical urine tube
75003767	10 ml blood collection
75003768	5/7 ml or 4.5/6 ml blood collection tube
75003755	30 ml Sterilin Universal tube
75003770	1.5/2 ml Microtube

TX-750 (microplate carriers)

Article No.	Description
Accessories	
75003180	TX-750 rotor cross
75003795	Microplate carriers and T-75 flasks (including plate trays and rubber pad) (2x)
75003617	Microplate carriers and T-75 flasks (including plate trays and rubber pad) (4x)

* Mind the information on assembling on page 2-7.

B. 3. 6. Biocontainment Certificate



Centre of Emergency Preparedness and Response
Health Protection Agency
Porton Down
Salisbury
Wiltshire SP4 0JG
United Kingdom



Certificate of Containment Testing

**Containment testing of Thermo Scientific
Swing out bucket rotor 75003607 and
bucket 75003608**

Report No. 59-08 C

Report prepared for: Thermo Fisher
Issue Date: 15th January 2009

Test Summary

A Thermo Scientific 75003608 centrifuge bucket with aerosol tight lid (Max speed 4,700 rpm) was supplied by Thermo Fisher and containment tested at 4,700 rpm using the method described in Annex AA of EN 61010-2-020. The rotor was shown to contain a spill when tested in triplicate.

Report Written By *[Signature]* **Report Authorised By** *[Signature] (23/1/09)*

Centre of Emergency Preparedness and Response
Health Protection Agency
Porton Down
Salisbury
Wiltshire SP4 0JG
United Kingdom



Certificate of Containment Testing

**Containment testing of Thermo Scientific
swing out bucket rotor 75003607 and
bucket 75003614**

Report No. 59-08 D

Report prepared for: Thermo Fisher
Issue Date: 15th January 2009

Test Summary

A Thermo Scientific 75003614 centrifuge bucket with aerosol tight lid (Max speed 4,700 rpm) was supplied by Thermo Fisher and containment tested at 4,700 rpm using the method described in Annex AA of EN 61010-2-020. The rotor was shown to contain a spill when tested in triplicate.

Report Written By *[Signature]* **Report Authorised By** *[Signature] (23/1/09)*



B. 4. TX-1000

B. 4. 1. Items Supplied

Article No.	Item	Quantity
75003017	TX-1000 rotor cross	1
75003001	TX-1000 buckets	4
50157859	Rotor safety information	1
75003786	Bolt grease	1
50158588	GP rotors information card	1

B. 4. 2. Technical Data

General Technical Data	
Weight (empty)	9.8 kg
Maximum Permissible Load	4 x 1500 g
Max. Cycle Number	55 000
Radius max. / min.	209 mm / 108 mm
Angle	90°
Aerosol-tight	Optional
Max. Autoclaving Temperature	121 °C

Performance data of the compatible ventilated 4 L centrifuges

SL4 Plus / SL4 Plus-MD SL4F Plus / SL4F Plus-MD		
Centrifuge Voltage	208-240 V, 50/60 Hz 220-240 V, 50 Hz 230 V, 60 Hz	120 V, 60 Hz
Maximum Speed n_{max}	3800 rpm	3800 rpm
Maximum RCF-Value at n_{max}	3374 x g	3374 x g
K-Factor at n_{max}	11 567	11 567
Acceleration / Braking Time	60 s / 60 s	75 s / 65 s
Temperature increase in the sample after 1 h of continuous run, tolerance $\pm 2K$	9 °C	9 °C

Performance data of the compatible refrigerated 4 L centrifuges

SL4R Plus / SL4R Plus-MD SL4RF Plus / SL4RF Plus-MD		
Centrifuge Voltage	220 V, 60 Hz 220-240 V, 50 Hz 230 V, 60 Hz	120 V, 60 Hz
Maximum Speed n_{max}	4200 rpm	4200 rpm
Maximum RCF-Value at n_{max}	4 122 x g	4 122 x g
K-Factor at n_{max}	9469	9469
Acceleration / Braking Time	65 s / 75 s	85 s / 75 s
Maximum Speed at 4 °C	4200 rpm	4000 rpm
Sample Temperature at max. Speed (ambient temp. at 23 °C, run time 2 h), tolerance $\pm 2 K$	2 °C	10 °C



B. 4. 3. Accessories

Article No.	Description
Accessories	
75003017	TX-1000 rotor cross
75003001	TX-1000 buckets (4x)
75007309	TX-1000 ClickSeal biocontainment lids (4x)
75007001	Replacement O-rings
75007300	1000 ml Bio-bottle - polypropylene (4x)
Adapters used for Laboratory Use	
75007301	1000 ml Bio-bottle (75007300)
75007304	750 ml polypropylene Bio-bottle
75004253	500 ml Nalgene bottle
75007302	500 ml Corning bottle (requires Corning 431124)
75005392	250 ml Corning Conical bottle or 200 ml Nunc™ bottle or 175 ml Nalgene conical bottle
75007305	250 ml Nalgene bottle / 225 ml BD Falcon™ (requires BD #352090) / 200 ml Nunc conical bottle (requires Nunc #377585) / 175 ml Nalgene conical bottle (requires Nalgene #DS3126-0175)
75004252	50 ml Nalgene Oak Ridge tube
75003829	Small bag/cell culture bags 4 x 2 bags (< 350 ml)
Adapters used for IVD	
75003674	50 ml conical tube
75004255	50 ml double biocontainment vessel for 50 ml conical tube (can be combined with ClickSeal lids)
75007306	15 ml conical tube
75003672	10 ml blood collection tube (16 x 100 mm) or Corex™/Kimble™ tubes
75003697	9/10 ml blood collection tube (Sarstedt™)
75003671	5/7 ml blood collection tube (13 x 75-100 mm)
75003709	4.5/6 ml blood collection tube (Greiner™)
75007303	Microplate carriers

B. 4. 4. Biocontainment Certificate

Health Protection Agency
Microbiology Services
Purton Down
Salisbury
Wiltshire
SP4 0JG



Certificate of Containment Testing

Containment Testing of Thermo Scientific TX-1000 Rotor in a Thermo Scientific Centrifuge

Report No. 170-12 G1

Report Prepared For: Thermo Fisher Scientific
Issue Date: 10th October 2012 re-issued 21st August 2013

Test Summary

Thermo Scientific TX-1000 Rotor is identical to the rotor tested according to report 170-12 G. We consider that this rotor will match the performance of that previously containment tested in a Thermo Scientific centrifuge at 5,500 rpm, using Annex AA of IEC 61010-2-020:2005 (2nd Ed.). The sealed rotor was shown to contain all contents.

Report Written By  Name: Ms Anna May Title: Biosafety Scientist	Report Authorised By  Name: Mr Simon Parks Title: Senior Biosafety Scientist
--	--

Thermo Scientific is a trademark of Thermo Fisher Scientific and is registered with the USPTO.



B. 5. H-FLEX 1

B. 5. 1. Items Supplied

Article No.	Item	Quantity
75003300	H-FLEX 1 rotor	1
50157859	Rotor safety information	1
75003786	Bolt grease	1
50158588	GP rotors information card	1

Performance data of the compatible ventilated 1 L centrifuges

SL1 Plus / SL1 Plus-MD	
Centrifuge Voltage	100-240 V, 50/60 Hz
Maximum Speed n_{max}	4 700 rpm
Maximum RCF-Value at n_{max}	4 297 x g
K-Factor at n_{max}	19 394
Acceleration / Braking Time	35 s / 35 s
Temperature increase in the sample after 1 h of continuous run, tolerance $\pm 2K$	9 °C

B. 5. 2. Technical Data

General Technical Data	
Weight (empty)	6.0 kg
Maximum Permissible Load	2 x 1115 g
Max. Cycle Number	55000
Radius max. / min.	174 mm / 32 mm
Angle	90°
Aerosol-tight	Yes
Max. Autoclaving Temperature	121 °C
Not Autoclavable Parts	O-ring 20058488

Performance data of the compatible refrigerated 1 L centrifuges

SL1R Plus / SL1R Plus-MD		
Centrifuge Voltage	220-230 V, 50/60 Hz	120 V, 60 Hz
Maximum Speed n_{max}	4 700 rpm	4 700 rpm
Maximum RCF-Value at n_{max}	4 297 x g	4 297 x g
K-Factor at n_{max}	19 394	19 394
Acceleration / Braking Time	40 s / 40 s	40 s / 40 s
Maximum Speed at 4 °C	4 700 rpm	4 700 rpm
Sample Temperature at max. Speed (ambient temp. at 23 °C, run time 2 h), tolerance $\pm 2 K$	-3 °C	2 °C



B. 5. 3. Accessories

Article No.	Description
Accessories	
75003301	H-Flex 1 Rotor bucket, set of 2
75003302	Bucket cap H-Flex 1, set of 2
Adapters used for Laboratory Use	
75003308	Adapter for TX-400 (see on page B-5)
Adapters used for IVD	
75003303	50 ml conical tube
75003304	15 ml conical tube
75003305	10/12 ml blood collection tube
75003306	5/7 ml blood collection tube
75003307	Microplate carriers

B. 5. 4. Biocontainment Certificate



Public Health England
National Infection Service
Porton Down
Salisbury
Wiltshire
SP4 0JG

Certificate of Containment Testing

**Containment Testing of Thermo Scientific
Swinging Buckets (75003301) and
Sealing Caps (75003302)
in a H-Flex 1 (75003300) rotor
in a Thermo Scientific Centrifuge**

Report No. 18-015

Report Prepared For: Thermo Fisher Scientific
Issue Date: 04 September 2018

Test Summary

Thermo Scientific Swinging Buckets (75003301) and Sealing Caps (75003302) in a H-Flex 1 rotor (75003300) were containment tested in a Thermo Scientific centrifuge at 4,700 rpm, using Annex AA of IEC 61010-2-020:2016 (3rd Ed.). The sealed buckets were shown to contain all contents.

Report Written By

Name: Ms Anna May
Title: Biosafety Scientist

Report Authorised By

Name: Nina Sara Spright
Title: Senior Biosafety Scientist

Please be aware that the use of the Royal Coat of Arms is highly restricted and cannot be copied. Please do not put the PH logo on your website or use our name to endorse your products. Any reference to PH needs to be approved by us before it can be used.



B. 6. H-FLEX HS4

B. 6. 1. Items Supplied

Article No.	Item	Quantity
75003330	H-FLEX HS4 rotor	1
76003500	Rubber seal grease	1
75003786	Bolt grease	1
50158588	GP rotors information card	1
50157859	Rotor safety information	1

Performance data of the compatible ventilated 4 L centrifuges

SL4 Plus / SL4 Plus-MD SL4F Plus / SL4F Plus-MD		
Centrifuge Voltage	208-240 V, 50/60 Hz 220-240 V, 50 Hz 230 V, 60 Hz	120 V, 60 Hz
Maximum Speed n_{max}	6100 rpm	6100 rpm
Maximum RCF-Value at n_{max}	7196 x g	7196 x g
K-Factor at n_{max}	11474	11474
Acceleration / Braking Time	65 s / 85 s	70 s / 85 s
Temperature increase in the sample after 1 h of continuous run, tolerance $\pm 2K$	21 °C	21 °C

B. 6. 2. Technical Data

General Technical Data	
Weight (empty)	5.4 kg
Maximum Permissible Load	2 x 1115 g
Max. Cycle Number	22000
Radius max. / min.	173 mm / 32 mm
Angle	90°
Aerosol-tight	Yes
Max. Autoclaving Temperature	121 °C
Not Autoclavable Parts	Gasket 20290682

Performance data of the compatible refrigerated 4 L centrifuges

SL4R Plus / SL4R Plus-MD SL4RF Plus / SL4RF Plus-MD		
Centrifuge Voltage	220 V, 60 Hz 220-240 V, 50 Hz 230 V, 60 Hz	120 V, 60 Hz
Maximum Speed n_{max}	6100 rpm	6100 rpm
Maximum RCF-Value at n_{max}	7196 x g	7196 x g
K-Factor at n_{max}	11474	11474
Acceleration / Braking Time	60 s / 70 s	60 s / 70 s
Maximum Speed at 4 °C	6100 rpm	5600 rpm
Sample Temperature at max. Speed (ambient temp. at 23 °C, run time 2 h), tolerance $\pm 2 K$	-1 °C	10 °C



B. 6. 3. Accessories

Article No.	Description
Accessories	
75003338	Bucket H-Flex HS4 (2x)
75003339	Windshield Lid H-Flex HS4
Adapters used for Laboratory Use	
75003308	Adapter TX-400
Adapters used for IVD	
75003303	50 ml conical tube
75003304	15 ml conical tube
75003305	10/12 ml blood collection tube
75003306	5/7 ml blood collection tube
75003307	Microplate carriers

B. 6. 4. Biocontainment Certificate

Public Health
England

Public Health England
National Infection Service
Potters Down
Salisbury
Wiltshire
SP4 6UG

Certificate of Containment Testing

**Containment Testing of
Thermo Scientific
H-Flex HS4 rotor (75003330) in
a Thermo Scientific Centrifuge**

Report No. 19-085

Report Prepared For: Thermo Fisher Scientific
Issue Date: 22 July 2020

Test Summary

Thermo Scientific H-Flex HS4 rotor (75003330) was containment tested in a Thermo Scientific centrifuge at 6,100 rpm, using Annex AA of IEC 61010-2-020:2016 (3rd Ed.). The sealed rotor was shown to contain all contents.

Report Written By

Name: Ms Helen Hookway
Title: Biocafety Scientist

Report Authorised By

Name: Mrs Sara Spaight
Title: Senior Biocafety Scientist

Report prepared from the copy of the final test of results (signed, witnessed and sealed). Please do not put the final test on any website or public domain to ensure your biosecurity. This certificate is the final copy approved by all relevant UK and EU staff.



B. 7. M-20 Microplate

B. 7. 1. Items Supplied

Article No.	Item	Quantity
75003624	M-20 Microplate	1
76003500	Rubber seal grease	1
75003786	Bolt grease	1
50158588	GP rotors information card	1

B. 7. 2. Technical Data

General Technical Data	
Weight (empty)	4.23 kg
Maximum Permissible Load	2 x 770 g
Max. Cycle Number	50 000
Radius max. / min.	127 mm / 79 mm
Angle	90°
Aerosol-tight	Optional
Max. Autoclaving Temperature	121 °C

Performance data of the compatible ventilated 1 L centrifuges

SL1 Plus / SL1 Plus-MD	
Centrifuge Voltage	100-240 V, 50/60 Hz
Maximum Speed n_{max}	4 000 rpm
Maximum RCF-Value at n_{max}	2 272 x g
K-Factor at n_{max}	7 507
Acceleration / Braking Time	20 s / 30 s
Temperature increase in the sample after 1 h of continuous run, tolerance $\pm 2K$	7 °C

Performance data of the compatible refrigerated 1 L centrifuges

SL1R Plus / SL1R Plus-MD		
Centrifuge Voltage	220-230 V, 50/60 Hz	120 V, 60 Hz
Maximum Speed n_{max}	4 000 rpm	4 000 rpm
Maximum RCF-Value at n_{max}	2 272 x g	2 272 x g
K-Factor at n_{max}	7 507	7 507
Acceleration / Braking Time	20 s / 30 s	20 s / 30 s
Maximum Speed at 4 °C	4 000 rpm	4 000 rpm
Sample Temperature at max. Speed (ambient temp. at 23 °C, run time 2 h), tolerance $\pm 2 K$	-7 °C	-6 °C

Performance data of the compatible ventilated 4 L centrifuges

SL4 Plus / SL4 Plus-MD SL4F Plus / SL4F Plus-MD		
Centrifuge Voltage	208-240 V, 50/60 Hz 220-240 V, 50 Hz 230 V, 60 Hz	120 V, 60 Hz
Maximum Speed n_{max}	4 000 rpm	4 000 rpm
Maximum RCF-Value at n_{max}	2 272 x g	2 272 x g
K-Factor at n_{max}	7 507	7 507
Acceleration / Braking Time	20 s / 30 s	20 s / 30 s
Temperature increase in the sample after 1 h of continuous run, tolerance $\pm 2K$	9 °C	9 °C

Performance data of the compatible refrigerated 4 L centrifuges

SL4R Plus / SL4R Plus-MD SL4RF Plus / SL4RF Plus-MD		
Centrifuge Voltage	220 V, 60 Hz 220-240 V, 50 Hz 230 V, 60 Hz	120 V, 60 Hz
Maximum Speed n_{max}	4 000 rpm	4 000 rpm
Maximum RCF-Value at n_{max}	2 272 x g	2 272 x g
K-Factor at n_{max}	7 507	7 507
Acceleration / Braking Time	20 s / 30 s	20 s / 30 s
Maximum Speed at 4 °C	4 000 rpm	4 000 rpm
Sample Temperature at max. Speed (ambient temp. at 23 °C, run time 2 h), tolerance $\pm 2 K$	-7 °C	-6 °C



B. 7. 3. Accessories

Article No.	Description
Accessories	
75002011	Replacement sealing lids (2x)
75002012	Replacement O-rings (4x)
Adapters used for IVD	
Included	Microplate carriers
76003625	Aerosol-tight capsule
75003624	M-20 rotor cross

B. 7. 4. Biocontainment Certificate

Centre of Emergency Preparedness and Response
Health Protection Agency
Porton Down
Salisbury
Wiltshire SP4 0JG
United Kingdom



Certificate of Containment Testing

**Containment testing of
Thermo Scientific swing out bucket rotor
75003624 and buckets 75003625**

Report No. 77-08 C

Report prepared for: Thermo Fisher
Issue Date: 1st June 2009

Test Summary

A Thermo Scientific centrifuge bucket 75003625 with aerosol tight lid (Max speed 4,000 rpm) was supplied by Thermo Fisher and containment tested at 4,000 rpm using the method described in Annex AA of EN 61010-2-020. The rotor was shown to contain a spill when tested in triplicate.

Report Written By  Report Authorised By 



B. 8. BIOShield 720

B. 8. 1. Items Supplied

Article No.	Item	Quantity
75003183	BIOShield 720 rotor	1
76003500	Rubber seal grease	1
75003786	Bolt grease	1
50158588	GP rotors information card	1
50157859	Rotor safety information	1

B. 8. 2. Technical Data

General Technical Data	
Weight (empty)	5.7 kg
Maximum Permissible Load	4 x 470 g
Max. Cycle Number	66 000
Radius max. / min.	162 mm / 67 mm
Angle	90°
Aerosol-tight	Yes
Max. Autoclaving Temperature	121 °C
Not Autoclavable Parts	Gasket 50117078

Performance data of the compatible ventilated 1 L centrifuges

SL1 Plus / SL1 Plus-MD	
Centrifuge Voltage	100-240 V, 50/60 Hz
Maximum Speed n_{max}	5 300 rpm
Maximum RCF-Value at n_{max}	5 088 x g
K-Factor at n_{max}	7 952
Acceleration / Braking Time	50 s / 65 s
Temperature increase in the sample after 1 h of continuous run, tolerance $\pm 2K$	14 °C

Performance data of the compatible refrigerated 1 L centrifuges

SL1R Plus / SL1R Plus-MD		
Centrifuge Voltage	220-230 V, 50/60 Hz	120 V, 60 Hz
Maximum Speed n_{max}	5 300 rpm	5 300 rpm
Maximum RCF-Value at n_{max}	5 088 x g	5 088 x g
K-Factor at n_{max}	7 952	7 952
Acceleration / Braking Time	55 s / 65 s	50 s / 65 s
Maximum Speed at 4 °C	5 300 rpm	5 300 rpm
Sample Temperature at max. Speed (ambient temp. at 23 °C, run time 2 h), tolerance $\pm 2 K$	-4 °C	2 °C



B. 8. 3. Accessories

Article No.	Description
Accessories	
75003693	180 ml Bio-Bottle - Polypropylene (12x)
75003622	Sealing kit
Adapters used for Laboratory Use	
75003813	150 ml round bottom open-top tube
75003814	100 ml round bottom open-top tube
75003816	50 ml DIN round bottom tube
75003817	25 ml DIN round bottom tube
75003820	15 ml Sarstedt tube
75003822	5/7 ml round bottom open-top tube
Adapters used for IVD	
75003677	50 ml conical tube
75003818	30 ml Sterilin universal tube
75003678	15 ml conical tube
75003701	10 ml blood collection tube (16 x 100 mm)
75003821	5/7 ml blood collection tube (13 x 75-100 mm)
75003823	1.5/2 ml conical microtube

B. 8. 4. Biocontainment Certificate

Centre of Emergency Preparedness and Response
 Health Protection Agency
 Porton Down
 Salisbury
 Wiltshire SP14 6JQ
 United Kingdom



Certificate of Containment Testing

**Containment Testing of
 contained Bioshield 720 Thermo
 Scientific rotor 75003621**

Report No. 77-08 F

Report prepared for: Thermo Fisher
Issue Date: 1st June 2009

Test Summary

A Thermo Scientific 75003621 contained Bioshield 720 rotor (Max speed 6,300 rpm) was supplied by Thermo Fisher and containment tested at 6,300 rpm using the method described in Annex AA of EH 61010-2-C20. The rotor was shown to contain a spill when tested in triplicate.

Report Written By

Report Authorised By



B. 9. BIOShield 1000A

B. 9. 1. Items Supplied

Article No.	Item	Quantity
75003182	BIOShield 1000A	1
75003786	Bolt grease	1
76003500	Rubber seal grease	1
50158588	GP rotors information card	1
50157859	Rotor safety information	1

Performance data of the compatible ventilated 4 L centrifuges

SL4 Plus / SL4 Plus-MD SL4F Plus / SL4F Plus-MD		
Centrifuge Voltage	208-240 V, 50/60 Hz 220-240 V, 50 Hz 230 V, 60 Hz	120 V, 60 Hz
Maximum Speed n_{max}	5300 rpm	5300 rpm
Maximum RCF-Value at n_{max}	5590 x g	5590 x g
K-Factor at n_{max}	6981	6981
Acceleration / Braking Time	65 s / 85 s	75 s / 85 s
Temperature increase in the sample after 1 h of continuous run, tolerance $\pm 2K$	10 °C	10 °C

B. 9. 2. Technical Data

General Technical Data	
Weight (empty)	8,5 kg
Maximum Permissible Load	4 x 600 g
Max. Cycle Number	30 000
Radius max. / min.	178 mm / 82 mm
Angle	90°
Aerosol-tight	Yes
Max. Autoclaving Temperature	121 °C
Not Autoclavable Parts	Gasket 20290682

Performance data of the compatible refrigerated 4 L centrifuges

SL4R Plus / SL4R Plus-MD SL4RF Plus / SL4RF Plus-MD		
Centrifuge Voltage	220 V, 60 Hz 220-240 V, 50 Hz 230 V, 60 Hz	120 V, 60 Hz
Maximum Speed n_{max}	5300 rpm	5300 rpm
Maximum RCF-Value at n_{max}	5590 x g	5590 x g
K-Factor at n_{max}	6981	6981
Acceleration / Braking Time	70 s / 85 s	70 s / 85 s
Maximum Speed at 4 °C	5300 rpm	5300 rpm
Sample Temperature at max. Speed (ambient temp. at 23 °C, run time 2 h), tolerance $\pm 2 K$	-1 °C	1 °C



B. 9. 3. Accessories

Article No.	Description
Adapters used for Laboratory Use	
75003737	250 ml flat bottom bottle
75003738	150 ml round bottom open-top tube
75003742	100 ml round bottom open-top tube
75003749	50 ml round bottom tube
75003750	45 ml flat/round tube
75003756	25 ml DIN round bottom tube
75003758	14 ml flanged round bottom tube
75003769	5/7 ml round bottom tube (13 x 75-100 mm)
Adapters used for IVD	
75003755	30 ml Sterilin Universal tube
75003759	14 ml round or conical urine tube
75003767	10 ml blood collection (16 x 100 mm) or 15 ml DIN tube
75003768	5/7 ml or 4.5/6 ml blood collection tube
75003643	50 ml conical tube
75003642	15 ml conical tube
75003770	1.5/2 ml Microtube

B. 9. 4. Biocontainment Certificate

Public Health
England

Public Health England
National Infection Service
Pulvis Dawn
Babraham
Hemel Hempstead
Herts SG8 6LN

Certificate of Containment Testing

**Containment Testing of
Thermo Scientific BIOShield™
1000A (75003182) Rotor in a
Thermo Scientific Centrifuge**

Report No. 18-051

Report Prepared For: Thermo Fisher Scientific
Issue Date: 04 April 2019

Test Summary

Thermo Scientific BIOShield™ 1000A (75003182) rotor was containment tested in a Thermo Scientific centrifuge at 6,000 rpm, using Annex AA of IEC 61010-2-020:2016 (3rd Ed.). The sealed rotor was shown to contain all contents.

Report Written By

Name: Ms Anna May
Title: Biosafety Scientist

Report Authorised By

Name: Mrs Sara Scaight
Title: Senior Biosafety Scientist

Public Health England is not responsible for the accuracy of the information contained in this report. The information is provided for your information only and should not be used for any other purpose. The information is provided for your information only and should not be used for any other purpose.



B. 10. CLINIConic

B. 10. 2. Technical Data

B. 10. 1. Items Supplied

Article No.	Item	Quantity
75003623	CLINIConic rotor	1
50158588	GP rotors information card	1
50157859	Rotor safety information	1
50143707	Small benchtop rotors CD	1

General Technical Data	
Weight (empty)	4.7 kg
Maximum Permissible Load	30 x 30 g
Max. Cycle Number	50 000
Radius max. / min.	140 mm / 85 mm
Angle	37°
Aerosol-tight	No
Max. Autoclaving Temperature	121 °C

Performance data of the compatible ventilated 1 L centrifuges

SL1 Plus / SL1 Plus-MD	
Centrifuge Voltage	100-240 V, 50/60 Hz
Maximum Speed n_{max}	5 650 rpm
Maximum RCF-Value at n_{max}	4 997 x g
K-Factor at n_{max}	3 955
Acceleration / Braking Time	20 s / 35 s
Temperature increase in the sample after 1 h of continuous run, tolerance $\pm 2K$	13 °C

Performance data of the compatible refrigerated 1 L centrifuges

SL1R Plus / SL1R Plus-MD		
Centrifuge Voltage	220-230 V, 50/60 Hz	120 V, 60 Hz
Maximum Speed n_{max}	5 650 rpm	5 650 rpm
Maximum RCF-Value at n_{max}	4 997 x g	4 997 x g
K-Factor at n_{max}	3 955	3 955
Acceleration / Braking Time	20 s / 35 s	20 s / 35 s
Maximum Speed at 4 °C	5 650 rpm	5 650 rpm
Sample Temperature at max. Speed (ambient temp. at 23 °C, run time 2 h), tolerance $\pm 2 K$	-3 °C	2 °C



B. 10. 3. Accessories

Article No.	Description
Adapters used for Laboratory Use	
75003702	10 ml round bottom tube
Adapters used for IVD	
11172596	7 ml blood collection tubes (13 x 100 mm)
11172595	5 ml blood collection tubes (13 x 75 mm)



B. 11. 8 x 50 mL Sealed

B. 11. 2. Technical Data

B. 11. 1. Items Supplied

Article No.	Item	Quantity
75003694	8 x 50 Individually sealed fixed angle rotor	1
50158588	GP rotors information card	1
50157859	Rotor safety information	1

General Technical Data	
Weight (empty)	3.3 kg
Maximum Permissible Load	8 x 189 g
Max. Cycle Number	50000
Radius max. / min.	143 mm / 69 mm
Angle	45°
Aerosol-tight	Yes
Max. Autoclaving Temperature	121 °C

Performance data of the compatible ventilated 1 L centrifuges

SL1 Plus / SL1 Plus-MD	
Centrifuge Voltage	100-240 V, 50/60 Hz
Maximum Speed n_{max}	6700 rpm
Maximum RCF-Value at n_{max}	7 177 x g
K-Factor at n_{max}	4 107
Acceleration / Braking Time	25 s / 35 s
Temperature increase in the sample after 1 h of continuous run, tolerance $\pm 2K$	15 °C

Performance data of the compatible refrigerated 1 L centrifuges

SL1R Plus / SL1R Plus-MD		
Centrifuge Voltage	220-230 V, 50/60 Hz	120 V, 60 Hz
Maximum Speed n_{max}	6700 rpm	6700 rpm
Maximum RCF-Value at n_{max}	7 177 x g	7 177 x g
K-Factor at n_{max}	4 107	4 107
Acceleration / Braking Time	25 s / 35 s	25 s / 35 s
Maximum Speed at 4 °C	6700 rpm	6500 rpm
Sample Temperature at max. Speed (ambient temp. at 23 °C, run time 2 h), tolerance $\pm 2 K$	1 °C	8 °C



B. 11. 3. Accessories

Article No.	Description
Adapters used for IVD	
75005755	15 ml conical tube
75005747	10 ml blood collection tube (16 x 100 mm)
75005748	7 ml blood collection tube (13 x 100 mm)
75005749	3.5 ml blood collection tube

B. 11. 4. Biocontainment Certificate

Centre of Emergency Preparedness and Response
Health Protection Agency
Porton Down
Salisbury
Wiltshire SP4 6JG
United Kingdom



Certificate of Containment Testing

Containment testing of Thermo Scientific Vessel 75003787

Report No. 77-08 B

Report prepared for: Thermo Fisher
Issue Date: 1st June 2009

Test Summary

A Thermo Scientific vessel 75003787 with aerosol tight lid (Max rcf 7177 x g) was supplied by Thermo Fisher and containment tested at max rcf 7177 x g using the method described in Annex AA of EN 61010-2-020. The vessel was shown to contain a spill when tested in triplicate.

Report Written By

Report Authorised By



B. 12. HIGHConic II

B. 12. 1. Items Supplied

Article No.	Item	Quantity
75003620	HIGHConic II	1
75003103	HIGHConic II adapter 1x50 ml	6
50158588	GP rotors information card	1
50157859	Rotor safety information	1

Performance data of the compatible ventilated 1 L centrifuges

SL1 Plus / SL1 Plus-MD	
Centrifuge Voltage	100-240 V, 50/60 Hz
Maximum Speed n_{max}	10350 rpm
Maximum RCF-Value at n_{max}	15090 x g
K-Factor at n_{max}	1713
Acceleration / Braking Time	40 s / 55 s
Temperature increase in the sample after 1 h of continuous run, tolerance $\pm 2K$	19 °C

Performance data of the compatible ventilated 4 L centrifuges

SL4 Plus / SL4 Plus-MD SL4F Plus / SL4F Plus-MD		
Centrifuge Voltage	208-240 V, 50/60 Hz 220-240 V, 50 Hz 230 V, 60 Hz	120 V, 60 Hz
Maximum Speed n_{max}	10350 rpm	10350 rpm
Maximum RCF-Value at n_{max}	15090 x g	15090 x g
K-Factor at n_{max}	1713	1713
Acceleration / Braking Time	40 s / 55 s	40 s / 60 s
Temperature increase in the sample after 1 h of continuous run, tolerance $\pm 2K$	15 °C	15 °C

B. 12. 2. Technical Data

General Technical Data	
Weight (empty)	3.6 kg
Maximum Permissible Load	6 x 140 g
Max. Cycle Number	50000
Radius max. / min.	126 mm / 61 mm
Angle	45°
Aerosol-tight	Yes
Max. Autoclaving Temperature	121 °C

Performance data of the compatible refrigerated 1 L centrifuges

SL1R Plus / SL1R Plus-MD		
Centrifuge Voltage	220-230 V, 50/60 Hz	120 V, 60 Hz
Maximum Speed n_{max}	10350 rpm	10350 rpm
Maximum RCF-Value at n_{max}	15090 x g	15090 x g
K-Factor at n_{max}	1713	1713
Acceleration / Braking Time	40 s / 60 s	40 s / 60 s
Maximum Speed at 4 °C	10350 rpm	10350 rpm
Sample Temperature at max. Speed (ambient temp. at 23 °C, run time 2 h), tolerance $\pm 2 K$	-1 °C	4 °C

Performance data of the compatible refrigerated 4 L centrifuges

SL4R Plus / SL4R Plus-MD SL4RF Plus / SL4RF Plus-MD		
Centrifuge Voltage	220 V, 60 Hz 220-240 V, 50 Hz 230 V, 60 Hz	120 V, 60 Hz
Maximum Speed n_{max}	10350 rpm	10350 rpm
Maximum RCF-Value at n_{max}	15090 x g	15090 x g
K-Factor at n_{max}	1713	1713
Acceleration / Braking Time	40 s / 60 s	40 s / 60 s
Maximum Speed at 4 °C	8500 rpm	8500 rpm
Sample Temperature at max. Speed (ambient temp. at 23 °C, run time 2 h), tolerance $\pm 2 K$	-3 °C	0 °C



B. 12. 3. Accessories

Article No.	Description
Accessories	
75003058	Replacement O-ring Kit
Adapters used for Laboratory Use	
75003102	50 ml Nalgene Oak Ridge tube
75003094	30 ml Nalgene Oak Ridge tube / 38 ml round tube
76002906	16 ml Nalgene Oak Ridge tube
75003093	10 ml Nalgene Oak Ridge tube / 12 ml round tube
75003092	6.5 ml round bottom tube
Adapters used for IVD	
75003103	50 ml conical tube
75003095	15 ml conical tube
75003091	1.5/2 ml Microtube

B. 12. 4. Biocontainment Certificate



Public Health
England

Public Health England
Microbiology Services
Porton Down
Salisbury
Wiltshire
SP4 0JG

Certificate of Containment Testing

**Containment Testing of
Thermo Scientific Rotor 75003620
HIGHConic II – 6x100ml
in a Thermo Scientific Centrifuge**

Report No. 36/13

Report Prepared For: Thermo Fisher Scientific
Issue Date: 4th November 2013

Test Summary

A Thermo Scientific 75003620 HIGHConic II – 6x100ml rotor was containment tested in a Thermo Scientific centrifuge at 12,000 rpm, using Annex AA of IEC 61010-2-020:2006 (2nd Ed.). The sealed rotor was shown to contain all contents.

Report Written By



Name: Miss Anna May
Title: Biosafety Scientist

Report Authorised By



Name: Mrs Sara Spright
Title: Senior Biosafety Scientist

Please be aware that the use of this form is highly restricted and cannot be copied. Please do not use the PH logo on your website or any other media to endorse your products. Any reference to PH needs to be approved by us before it can be used.



B. 13. Microliter 30 x 2

B. 13. 1. Items Supplied

Article No.	Item	Quantity
75003652	Microliter 30 x 2	1
50158588	GP rotors information card	1
50157859	Rotor safety information	1
75003349	O-Ring kit	1

B. 13. 2. Technical Data

General Technical Data	
Weight (empty)	2.1 kg
Maximum Permissible Load	30 x 4 g
Max. Cycle Number	50 000
Radius max. / min.	100 mm / 64 mm
Angle	45°
Aerosol-tight	Optional
Max. Autoclaving Temperature	138 °C

Performance data of the compatible ventilated 1 L centrifuges

SL1 Plus / SL1 Plus-MD	
Centrifuge Voltage	100-240 V, 50/60 Hz
Maximum Speed n_{max}	15 200 rpm
Maximum RCF-Value at n_{max}	25 830 x g
K-Factor at n_{max}	489
Acceleration / Braking Time	30 s / 45 s
Temperature increase in the sample after 1 h of continuous run, tolerance $\pm 2K$	23 °C

Performance data of the compatible refrigerated 1 L centrifuges

SL1R Plus / SL1R Plus-MD		
Centrifuge Voltage	220-230 V, 50/60 Hz	120 V, 60 Hz
Maximum Speed n_{max}	15 200 rpm	15 200 rpm
Maximum RCF-Value at n_{max}	25 830 x g	25 830 x g
K-Factor at n_{max}	489	489
Acceleration / Braking Time	30 s / 45 s	30 s / 45 s
Maximum Speed at 4 °C	15 200 rpm	14 000 rpm
Sample Temperature at max. Speed (ambient temp. at 23 °C, run time 2 h), tolerance $\pm 2 K$	5 °C	8 °C

Performance data of the compatible ventilated 4 L centrifuges

SL4 Plus / SL4 Plus-MD SL4F Plus / SL4F Plus-MD		
Centrifuge Voltage	208-240 V, 50/60 Hz 220-240 V, 50 Hz 230 V, 60 Hz	120 V, 60 Hz
Maximum Speed n_{max}	15 200 rpm	15 200 rpm
Maximum RCF-Value at n_{max}	25 830 x g	25 830 x g
K-Factor at n_{max}	489	489
Acceleration / Braking Time	30 s / 45 s	30 s / 45 s
Temperature increase in the sample after 1 h of continuous run, tolerance $\pm 2K$	21 °C	21 °C

Performance data of the compatible refrigerated 4 L centrifuges

SL4R Plus / SL4R Plus-MD SL4RF Plus / SL4RF Plus-MD		
Centrifuge Voltage	220 V, 60 Hz 220-240 V, 50 Hz 230 V, 60 Hz	120 V, 60 Hz
Maximum Speed n_{max}	15 200 rpm	15 200 rpm
Maximum RCF-Value at n_{max}	25 830 x g	25 830 x g
K-Factor at n_{max}	489	489
Acceleration / Braking Time	30 s / 45 s	30 s / 45 s
Maximum Speed at 4 °C	15 200 rpm	14 800 rpm
Sample Temperature at max. Speed (ambient temp. at 23 °C, run time 2 h), tolerance $\pm 2 K$	2 °C	7 °C



B. 13. 3. Accessories

Article No.	Description
Accessories	
75003349	Replacement O-ring kit
Adapters used for IVD	
75005754	0.25 ml Microtube
75005753	0.5 ml Microtube
76003752	0.2 ml PCR tube

B. 13. 4. Biocontainment Certificate

Centre of Emergency Preparedness and Response
 Health Protection Agency
 Porton Down
 Salisbury
 Wiltshire SP4 0JG
 United Kingdom



Certificate of Containment Testing

**Containment Testing of
 Thermo Scientific rotor 75003652**

Report No. 77-08 H

Report prepared for: Thermo Fisher
Issue Date: 1st June 2009

Test Summary

A Thermo Scientific contained rotor 75003652 (Max speed 15,200 rpm) was supplied by Thermo Fisher and containment tested at 15,200 rpm using the method described in Annex AA of EN 61010-2-020. The rotor was shown to contain a spill when tested in triplicate.

Report Written By  **Report Authorised By** 



B. 14. Microliter 48 x 2

B. 14. 1. Items Supplied

Article No.	Item	Quantity
75003602	Microliter 48 x 2 rotor	1
76003500	Rubber seal grease	1
50158588	GP rotors information card	1
50157859	Rotor safety information	1
75003349	O-Ring kit	1

Performance data of the compatible ventilated 1 L centrifuges

SL1 Plus / SL1 Plus-MD	
Centrifuge Voltage	100-240 V, 50/60 Hz
Maximum Speed n_{max}	15200 rpm
Maximum RCF-Value at n_{max}	25314 x g
K-Factor at n_{max}	556
Acceleration / Braking Time	30 s / 45 s
Temperature increase in the sample after 1 h of continuous run, tolerance $\pm 2K$	22 °C

Performance data of the compatible ventilated 4 L centrifuges

SL4 Plus / SL4 Plus-MD SL4F Plus / SL4F Plus-MD		
Centrifuge Voltage	208-240 V, 50/60 Hz 220-240 V, 50 Hz 230 V, 60 Hz	120 V, 60 Hz
Maximum Speed n_{max}	15200 rpm	15200 rpm
Maximum RCF-Value at n_{max}	25314 x g	25314 x g
K-Factor at n_{max}	556	556
Acceleration / Braking Time	35 s / 50 s	35 s / 50 s
Temperature increase in the sample after 1 h of continuous run, tolerance $\pm 2K$	21 °C	21 °C

B. 14. 2. Technical Data

General Technical Data	
Weight (empty)	2.5 kg
Maximum Permissible Load	48 x 4 g
Max. Cycle Number	50000
Radius max. / min.	98 mm / 59 mm
Angle	45°
Aerosol-tight	Yes
Max. Autoclaving Temperature	138 °C

Performance data of the compatible refrigerated 1 L centrifuges

SL1R Plus / SL1R Plus-MD		
Centrifuge Voltage	220-230 V, 50/60 Hz	120 V, 60 Hz
Maximum Speed n_{max}	15200 rpm	15200 rpm
Maximum RCF-Value at n_{max}	25314 x g	25314 x g
K-Factor at n_{max}	556	556
Acceleration / Braking Time	30 s / 45 s	30 s / 45 s
Maximum Speed at 4 °C	15200 rpm	14500 rpm
Sample Temperature at max. Speed (ambient temp. at 23 °C, run time 2 h), tolerance $\pm 2 K$	3 °C	8 °C

Performance data of the compatible refrigerated 4 L centrifuges

SL4R Plus / SL4R Plus-MD SL4RF Plus / SL4RF Plus-MD		
Centrifuge Voltage	220 V, 60 Hz 220-240 V, 50 Hz 230 V, 60 Hz	120 V, 60 Hz
Maximum Speed n_{max}	15200 rpm	15200 rpm
Maximum RCF-Value at n_{max}	25314 x g	25314 x g
K-Factor at n_{max}	556	556
Acceleration / Braking Time	35 s / 50 s	35 s / 50 s
Maximum Speed at 4 °C	15200 rpm	15200 rpm
Sample Temperature at max. Speed (ambient temp. at 23 °C, run time 2 h), tolerance $\pm 2 K$	0 °C	4 °C



B. 14. 3. Accessories

Article No.	Description
Accessories	
75003349	Replacement O-ring kit
Adapters used for IVD	
75005754	0.25 ml Microtube
75005753	0.5 ml Microtube
76003752	0.2 ml PCR tube

B. 14. 4. Biocontainment Certificate





B. 15. MicroClick 30 x 2

B. 15. 1. Items Supplied

Article No.	Item	Quantity
75005719	MicroClick 30 x 2 rotor	1
70902041	ClickSeal lid	1
76003500	Rubber seal grease	1
75005726	O-ring set	1
50158588	GP rotors information card	1
50157859	Rotor safety information	1
50143707	Small benchtop rotors CD	1

Performance data of the compatible ventilated 1 L centrifuges

SL1 Plus / SL1 Plus-MD	
Centrifuge Voltage	100-240 V, 50/60 Hz
Maximum Speed n_{max}	14 000 rpm
Maximum RCF-Value at n_{max}	21 694 x g
K-Factor at n_{max}	563
Acceleration / Braking Time	30 s / 45 s
Temperature increase in the sample after 1 h of continuous run, tolerance $\pm 2K$	19 °C

Performance data of the compatible ventilated 4 L centrifuges

SL4 Plus / SL4 Plus-MD SL4F Plus / SL4F Plus-MD		
Centrifuge Voltage	208-240 V, 50/60 Hz 220-240 V, 50 Hz 230 V, 60 Hz	120 V, 60 Hz
Maximum Speed n_{max}	14 000 rpm	14 000 rpm
Maximum RCF-Value at n_{max}	21 694 x g	21 694 x g
K-Factor at n_{max}	563	563
Acceleration / Braking Time	30 s / 40 s	30 s / 40 s
Temperature increase in the sample after 1 h of continuous run, tolerance $\pm 2K$	18 °C	18 °C

B. 15. 2. Technical Data

General Technical Data	
Weight (empty)	1.44 kg
Maximum Permissible Load	30 x 4 g
Max. Cycle Number	50 000
Radius max. / min.	99 mm / 64 mm
Angle	45°
Aerosol-tight	Yes
Max. Autoclaving Temperature	138 °C

Performance data of the compatible refrigerated 1 L centrifuges

SL1R Plus / SL1R Plus-MD		
Centrifuge Voltage	220-230 V, 50/60 Hz	120 V, 60 Hz
Maximum Speed n_{max}	14 000 rpm	14 000 rpm
Maximum RCF-Value at n_{max}	21 694 x g	21 694 x g
K-Factor at n_{max}	563	563
Acceleration / Braking Time	30 s / 45 s	30 s / 45 s
Maximum Speed at 4 °C	15 200 rpm	14 000 rpm
Sample Temperature at max. Speed (ambient temp. at 23 °C, run time 2 h), tolerance $\pm 2 K$	0 °C	4 °C

Performance data of the compatible refrigerated 4 L centrifuges

SL4R Plus / SL4R Plus-MD SL4RF Plus / SL4RF Plus-MD		
Centrifuge Voltage	220 V, 60 Hz 220-240 V, 50 Hz 230 V, 60 Hz	120 V, 60 Hz
Maximum Speed n_{max}	14 000 rpm	14 000 rpm
Maximum RCF-Value at n_{max}	21 694 x g	21 694 x g
K-Factor at n_{max}	563	563
Acceleration / Braking Time	25 s / 40 s	30 s / 40 s
Maximum Speed at 4 °C	14 000 rpm	14 000 rpm
Sample Temperature at max. Speed (ambient temp. at 23 °C, run time 2 h), tolerance $\pm 2 K$	-3 °C	3 °C



B. 16. MicroClick 30 x 2

Article No.	Description
Accessories	
75003349	Replacement O-ring kit
Adapters used for IVD	
75005754	0.25 ml Microtube
75005753	0.5 ml Microtube
76003752	0.2 ml PCR tube

B. 16. 1. Biocontainment Certificate

Health Protection Agency
Microbiology Services
Porton Down
Salisbury
Wiltshire
SP4 6JG



Certificate of Containment Testing

Containment Testing of Rotor 75005719 MicroClick 30x2 in a Thermo Scientific Centrifuge

Report No. 194-12 B

Report Prepared For: Thermo Fisher Scientific
Issue Date: 30th October 2012

Test Summary

A 75005719 MicroClick 30x2 rotor was containment tested in a Thermo Scientific centrifuge at 15,000 rpm, using Annex AA of IEC 61010-2-20:2008 (2nd Ed.). The sealed rotor was shown to contain all contents.

Report Written By  Name: Ms Anna Moy Title: Biosafety Scientist	Report Authorised By  Name: Mrs Sara Speight Title: Senior Biosafety Scientist
--	--

Thermo Scientific is a trademark of Thermo Fisher Scientific and is registered with the USPTO.



B. 17. MicroClick 18 x 5

B. 17. 1. Items Supplied

Article No.	Item	Quantity
75005765	MicroClick 18 x 5	1
20059119	ClickSeal lid	1
76003500	Rubber seal grease	1
50158588	GP rotors information card	1
75005726	O-ring set	1
50157859	Rotor safety information	1

Performance data of the compatible ventilated 1 L centrifuges

SL1 Plus / SL1 Plus-MD	
Centrifuge Voltage	100-240 V, 50/60 Hz
Maximum Speed n_{max}	15 000 rpm
Maximum RCF-Value at n_{max}	24 652 x g
K-Factor at n_{max}	378
Acceleration / Braking Time	45 s / 30 s
Temperature increase in the sample after 1 h of continuous run, tolerance $\pm 2K$	22 °C

Performance data of the compatible ventilated 4 L centrifuges

SL4 Plus / SL4 Plus-MD SL4F Plus / SL4F Plus-MD		
Centrifuge Voltage	208-240 V, 50/60 Hz 220-240 V, 50 Hz 230 V, 60 Hz	120 V, 60 Hz
Maximum Speed n_{max}	14 000 rpm	14 000 rpm
Maximum RCF-Value at n_{max}	21 475 x g	21 475 x g
K-Factor at n_{max}	434	434
Acceleration / Braking Time	30 s / 45 s	30 s / 45 s
Temperature increase in the sample after 1 h of continuous run, tolerance $\pm 2K$	17 °C	17 °C

B. 17. 2. Technical Data

General Technical Data	
Weight (empty)	1.7 kg
Maximum Permissible Load	18 x 9 g
Max. Cycle Number	50 000
Radius max. / min.	98 mm / 70 mm
Angle	45°
Aerosol-tight	Yes
Max. Autoclaving Temperature	121 °C

Performance data of the compatible refrigerated 1 L centrifuges

SL1R Plus / SL1R Plus-MD		
Centrifuge Voltage	220-230 V, 50/60 Hz	120 V, 60 Hz
Maximum Speed n_{max}	15 000 rpm	15 000 rpm
Maximum RCF-Value at n_{max}	24 652 x g	24 652 x g
K-Factor at n_{max}	378	378
Acceleration / Braking Time	30 s / 45 s	30 s / 45 s
Maximum Speed at 4 °C	15 000 rpm	13 800 rpm
Sample Temperature at max. Speed (ambient temp. at 23 °C, run time 2 h), tolerance $\pm 2 K$	5 °C	10 °C

Performance data of the compatible refrigerated 4 L centrifuges

SL4R Plus / SL4R Plus-MD SL4RF Plus / SL4RF Plus-MD		
Centrifuge Voltage	220 V, 60 Hz 220-240 V, 50 Hz 230 V, 60 Hz	120 V, 60 Hz
Maximum Speed n_{max}	15 000 rpm	15 000 rpm
Maximum RCF-Value at n_{max}	24 652 x g	24 652 x g
K-Factor at n_{max}	378	378
Acceleration / Braking Time	30 s / 45 s	30 s / 45 s
Maximum Speed at 4 °C	15 000 rpm	14 200 rpm
Sample Temperature at max. Speed (ambient temp. at 23 °C, run time 2 h), tolerance $\pm 2 K$	2 °C	8 °C



B. 17. 3. Accessories

Article No.	Description
Accessories	
75005726	Replacement O-ring Kit
Adapters used for Laboratory Use	
75005756	1.2/2 ml Microtube
Adapters used for IVD	
75005756	1.5/2 ml Microtube

B. 17. 4. Biocontainment Certificate



Public Health England
Microbiology Services
Partner Organ
Safer
Working
SHE G20

Certificate of Containment Testing

**Containment Testing of
Thermo Scientific Rotor
MicroClick 18x5 (75005765)
in a Thermo Scientific Centrifuge**

Report No. 102/13

Report Prepared For: Thermo Fisher Scientific
Issue Date: 13th February 2014

Test Summary

A Thermo Scientific MicroClick 18x5 rotor (75005765) was containment tested in a Thermo Scientific centrifuge at 15,000 rpm, using Annex AA of IEC 61010-2-020:2008 (2nd Ed.). The sealed rotor was shown to contain all contents.

Report Written By

Report Authorised By

Anna May

Sara Speight

Name: Miss Anna May
Title: Biosafety Scientist

Name: Miss Sara Speight
Title: Senior Biosafety Scientist

Please be aware that the use of the Royal Coat of Arms is highly restricted and control its usage. Please do not put the RHC logo on your website or use our name to endorse your products. Any reference to RHC needs to be approved by us before it can be used.



B. 18. Fiberlite F15-6 x 100y

B. 18. 1. Items Supplied

Article No.	Item	Quantity
75003698*	Fiberlite F15-6 x 100y	1
50158588	GP rotors information card	1

* Identical with 096-069031.

B. 18. 2. Technical Data

General Technical Data	
Weight (empty)	3.63 kg
Maximum Permissible Load	6 x 126 g
Radius max. / min.	98 mm / 25 mm
Angle	25°
Aerosol-tight	Yes
Max. Autoclaving Temperature	121 °C

Performance data of the compatible ventilated 1 L centrifuges

SL1 Plus / SL1 Plus-MD	
Centrifuge Voltage	100-240 V, 50/60 Hz
Maximum Speed n_{max}	13 000 rpm
Maximum RCF-Value at n_{max}	18 516 x g
K-Factor at n_{max}	2 045
Acceleration / Braking Time	50 s / 60 s
Temperature increase in the sample after 1 h of continuous run, tolerance $\pm 2K$	19 °C

Performance data of the compatible refrigerated 1 L centrifuges

SL1R Plus / SL1R Plus-MD		
Centrifuge Voltage	220-230 V, 50/60 Hz	120 V, 60 Hz
Maximum Speed n_{max}	13 000 rpm	13 000 rpm
Maximum RCF-Value at n_{max}	18 516 x g	18 516 x g
K-Factor at n_{max}	2 045	2 045
Acceleration / Braking Time	50 s / 65 s	50 s / 65 s
Maximum Speed at 4 °C	13 000 rpm	12 600 rpm
Sample Temperature at max. Speed (ambient temp. at 23 °C, run time 2 h), tolerance $\pm 2 K$	1 °C	7 °C

Performance data of the compatible ventilated 4 L centrifuges

SL4 Plus / SL4 Plus-MD SL4F Plus / SL4F Plus-MD		
Centrifuge Voltage	208-240 V, 50/60 Hz 220-240 V, 50 Hz 230 V, 60 Hz	120 V, 60 Hz
Maximum Speed n_{max}	13 000 rpm	13 000 rpm
Maximum RCF-Value at n_{max}	18 516 x g	18 516 x g
K-Factor at n_{max}	2 045	2 045
Acceleration / Braking Time	45 s / 60 s	50 s / 60 s
Temperature increase in the sample after 1 h of continuous run, tolerance $\pm 2K$	16 °C	16 °C

Performance data of the compatible refrigerated 4 L centrifuges

SL4R Plus / SL4R Plus-MD SL4RF Plus / SL4RF Plus-MD		
Centrifuge Voltage	220 V, 60 Hz 220-240 V, 50 Hz 230 V, 60 Hz	120 V, 60 Hz
Maximum Speed n_{max}	13 000 rpm	13 000 rpm
Maximum RCF-Value at n_{max}	18 516 x g	18 516 x g
K-Factor at n_{max}	2 045	2 045
Acceleration / Braking Time	50 s / 65 s	50 s / 65 s
Maximum Speed at 4 °C	13 000 rpm	12 200 rpm
Sample Temperature at max. Speed (ambient temp. at 23 °C, run time 2 h), tolerance $\pm 2 K$	-2 °C	3 °C



B. 18. 3. Accessories

Article No.	Description
Accessories	
021-069031	Replacement O-ring Kit
Adapters used for Laboratory Use	
75003102	50 ml Nalgene Oak Ridge tube
76002906	16 ml Nalgene Oak Ridge tube
75003093	10 ml Nalgene Oak Ridge tube / 12 ml round tube
75003092	6.5 ml round bottom tube
75003094	30 ml Nalgene™ Oak Ridge tube / 38 ml round tube
Adapters used for IVD	
75003103	50 ml conical tube
75003095	15 ml conical tube
75003091	1.5/2 ml Microtube

B. 18. 4. Biocontainment Certificate



B. 18. 1.



B. 19. Fiberlite F21-48 x 2

B. 19. 1. Items Supplied

Article No.	Item	Quantity
75003664*	Fiberlite F21-48 x 2	1
50158588	GP rotors information card	1

* Identical with 096-489021.

B. 19. 2. Technical Data

General Technical Data	
Weight (empty)	2.6 kg
Maximum Permissible Load	48 x 4 g
Radius max. / min.	97 mm / 64 mm
Angle	45°
Aerosol-tight	Yes
Max. Autoclaving Temperature	121 °C

Performance data of the compatible ventilated 1 L centrifuges

SL1 Plus / SL1 Plus-MD	
Centrifuge Voltage	100-240 V, 50/60 Hz
Maximum Speed n_{max}	15 200 rpm
Maximum RCF-Value at n_{max}	25 055 x g
K-Factor at n_{max}	455
Acceleration / Braking Time	30 s / 45 s
Temperature increase in the sample after 1 h of continuous run, tolerance $\pm 2K$	21 °C

Performance data of the compatible refrigerated 1 L centrifuges

SL1R Plus / SL1R Plus-MD		
Centrifuge Voltage	220-230 V, 50/60 Hz	120 V, 60 Hz
Maximum Speed n_{max}	15 200 rpm	15 200 rpm
Maximum RCF-Value at n_{max}	25 055 x g	25 055 x g
K-Factor at n_{max}	455	455
Acceleration / Braking Time	30 s / 45 s	30 s / 45 s
Maximum Speed at 4 °C	15 200 rpm	14 500 rpm
Sample Temperature at max. Speed (ambient temp. at 23 °C, run time 2 h), tolerance $\pm 2 K$	4 °C	10 °C

Performance data of the compatible ventilated 4 L centrifuges

SL4 Plus / SL4 Plus-MD SL4F Plus / SL4F Plus-MD		
Centrifuge Voltage	208-240 V, 50/60 Hz 220-240 V, 50 Hz 230 V, 60 Hz	120 V, 60 Hz
Maximum Speed n_{max}	15 200 rpm	15 200 rpm
Maximum RCF-Value at n_{max}	25 055 x g	25 055 x g
K-Factor at n_{max}	455	455
Acceleration / Braking Time	35 s / 45 s	30 s / 45 s
Temperature increase in the sample after 1 h of continuous run, tolerance $\pm 2K$	22 °C	22 °C

Performance data of the compatible refrigerated 4 L centrifuges

SL4R Plus / SL4R Plus-MD SL4RF Plus / SL4RF Plus-MD		
Centrifuge Voltage	220 V, 60 Hz 220-240 V, 50 Hz 230 V, 60 Hz	120 V, 60 Hz
Maximum Speed n_{max}	15 200 rpm	15 200 rpm
Maximum RCF-Value at n_{max}	25 055 x g	25 055 x g
K-Factor at n_{max}	455	455
Acceleration / Braking Time	35 s / 45 s	35 s / 45 s
Maximum Speed at 4 °C	15 200 rpm	15 000 rpm
Sample Temperature at max. Speed (ambient temp. at 23 °C, run time 2 h), tolerance $\pm 2 K$	3 °C	7 °C



B. 19. 3. Accessories

Article No.	Description
Accessories	
021-489021	Replacement O-ring Kit
Adapters used for IVD	
76003750	0.2 ml PCR tube

B. 19. 4. Biocontainment Certificate

Centre of Emergency Preparedness and Response
Health Protection Agency
Porton Down
Salisbury
Wiltshire SP4 6JG
United Kingdom



Certificate of Containment Testing

Containment Testing of Fiberlite F21-48X1.5 Rotor in the Thermo Scientific GP3 Centrifuge

Report No. 59-09 A

Report prepared for: Thermo Fisher Scientific
Issue Date: 9th December 2009

Test Summary

A Piramoon technologies Inc. Fiberlite F21-48X1.5 (max speed 15,200rpm) rotor was containment tested in the Thermo Scientific GP3 centrifuge at 15,200rpm, using the method described in Annex AA of EN 61010-2-020. The rotor was shown to contain a spill within the rotor.

Report Written By

Anna May

Report Authorised By

[Signature]



B. 20. Fiberlite F10-6 x 100 LEX

B. 20. 2. Technical Data

B. 20. 1. Items Supplied

Article No.	Item	Quantity
75003340*	Fiberlite F10-6 x 100 LEX	1
50158588	GP rotors information card	1

* Identical with 096-069035.

General Technical Data	
Weight (empty)	3.3 kg
Maximum Permissible Load	6 x 126 g
Radius max. / min.	122 mm / 33 mm
Angle	45°
Aerosol-tight	Yes
Max. Autoclaving Temperature	121 °C

Performance data of the compatible ventilated 1 L centrifuges

SL1 Plus / SL1 Plus-MD	
Centrifuge Voltage	100-240 V, 50/60 Hz
Maximum Speed n_{max}	10500 rpm
Maximum RCF-Value at n_{max}	15038 x g
K-Factor at n_{max}	3000
Acceleration / Braking Time	45 s / 50 s
Temperature increase in the sample after 1 h of continuous run, tolerance $\pm 2K$	21 °C

Performance data of the compatible refrigerated 1 L centrifuges

SL1R Plus / SL1R Plus-MD		
Centrifuge Voltage	220-230 V, 50/60 Hz	120 V, 60 Hz
Maximum Speed n_{max}	10500 rpm	10500 rpm
Maximum RCF-Value at n_{max}	15038 x g	15038 x g
K-Factor at n_{max}	3000	3000
Acceleration / Braking Time	45 s / 50 s	45 s / 50 s
Maximum Speed at 4 °C	10500 rpm	10000 rpm
Sample Temperature at max. Speed (ambient temp. at 23 °C, run time 2 h), tolerance $\pm 2 K$	2 °C	7 °C

Performance data of the compatible ventilated 4 L centrifuges

SL4 Plus / SL4 Plus-MD SL4F Plus / SL4F Plus-MD		
Centrifuge Voltage	208-240 V, 50/60 Hz 220-240 V, 50 Hz 230 V, 60 Hz	120 V, 60 Hz
Maximum Speed n_{max}	10500 rpm	10500 rpm
Maximum RCF-Value at n_{max}	15038 x g	15038 x g
K-Factor at n_{max}	3000	3000
Acceleration / Braking Time	45 s / 50 s	45 s / 50 s
Temperature increase in the sample after 1 h of continuous run, tolerance $\pm 2K$	13 °C	13 °C

Performance data of the compatible refrigerated 4 L centrifuges

SL4R Plus / SL4R Plus-MD SL4RF Plus / SL4RF Plus-MD		
Centrifuge Voltage	220 V, 60 Hz 220-240 V, 50 Hz 230 V, 60 Hz	120 V, 60 Hz
Maximum Speed n_{max}	10500 rpm	10500 rpm
Maximum RCF-Value at n_{max}	15038 x g	15038 x g
K-Factor at n_{max}	3000	3000
Acceleration / Braking Time	45 s / 50 s	45 s / 50 s
Maximum Speed at 4 °C	10500 rpm	10500 rpm
Sample Temperature at max. Speed (ambient temp. at 23 °C, run time 2 h), tolerance $\pm 2 K$	-2 °C	5 °C



B. 20. 3. Accessories

Article No.	Description
Adapters used for Laboratory Use	
75003102	50 ml Nalgene Oak Ridge tube
76002906	16 ml Nalgene Oak Ridge tube
75003093	10 ml Nalgene Oak Ridge tube / 12 ml round tube
75003092	6.5 ml round bottom tube
75003094	30 ml Nalgene™ Oak Ridge tube / 38 ml round tube
Adapters used for IVD	
75003103	50 ml conical tube
75003095	15 ml conical tube
75003091	1.5/2 ml Microtube

B. 20. 4. Biocontainment Certificate



Public Health
England

Public Health England
Microbiology Services
Poker Down
Salisbury
Wiltshire
SP4 0JG

Certificate of Containment Testing

Containment Testing of
 Thermo Scientific Fiberlite
 F10-6 x 100 LEX rotor
 (096-069035, 75003340) in a
 Thermo Scientific Centrifuge
Report No. 18-022

Report Prepared For: Thermo Fisher Scientific
Issue Date: 07 September 2018

Test Summary

Thermo Scientific Fiberlite F10-6 x 100 LEX rotor (096-069035, 75003340) was containment tested in a Thermo Scientific centrifuge at 10,500 rpm, using Annex AA of IEC 61010-2-020:2018 (3rd Ed.). The sealed rotor was shown to contain all contents.

Report Written By



Name: Ms Anna May
Title: Biosafety Scientist

Report Authorised By



Name: Mrs Sara Spaight
Title: Senior Biosafety Scientist

Please do not use this report for legal purposes. It is a confidential document and should not be used for legal proceedings. Please do not use this report for any other purpose without the written consent of the author. Any information contained herein should be destroyed by the recipient 12 months after the date of issue.

C. Chemical Compatibility

Chemical Compatibility	
MATERIAL	CHEMICAL
Viton™	S U U U U U / S S
Tygon™	S / U U U S / S U
Titanium	S S S S S S / U S S S
Stainless Steel	S / M S S / U U S S M S S
Silicone Rubber	S U M S S / M S S S S
Rulon A™, Teflon™	S S S S S S S S S S S S S S
Polyvynil Chloride	U M U U S M S S S S S S S
Polysulfone	S / U U S / S S S S S S S
Polypropylene	S M S M S S S S S S S S S
Polyethylene	S M S S S S S S S S S S S
Polythermide	S U U / S S / U / S S S S
Polyester, Glass Thermoset	/ U U U S M S U U M M
Polycarbonate	S U U U M S S M S U U U
Polyallomer	S M S M S S S S S S S S S
PET ¹ , Polyclear™, Clear Crimp™	U / U U S / S S S S / U
Nylon	S / S U S S S M U S S S S S
Noryl™	S / U U S S / S S S S S S S
Neoprene	U U U S S / S S S S S S S
Glass	S / S S S / S S S S S S S
EPDM rubber	/ M S / / S S / S S S S S
Delrin™	S / M S S S U U S S M M
Composite Carbon Fiber/Epoxy	M / U M S S S / S S S U
Polyurethane Rotor Paint	S / S U S S S / S S S S S
Cellulose Acetate Butyrate	/ U U / S S / U S S U U U
Buna N	U U U U S / S S M U U S S S
Anodic Coating for Aluminum	S / S S U / U S S S S U U
Aluminium	S M S U / U S M S U U U
2-MERCAPTOETHANOL	S U
ACETALDEHYDE	S /
ACETONE	M
ACETONITRILE	S
ALCONOX™	U
ALLYL ALCOHOL	/
ALUMINIUM CHLORIDE	U
FORMIC ACID (100%)	/
AMMONIUM ACETATE	S
AMMONIUM CARBONATE	M
AMMONIUM HYDROXIDE (10%)	U
AMMONIUM HYDROXIDE (28%)	U
S	Satisfactory
M	Moderate attack, may be satisfactory for use in centrifuge depending on length of exposure, speed involved, etc.; suggest testing under actual conditions of use
U	Unsatisfactory, not recommended
/	Performance unknown; suggest testing, using sample to avoid loss of valuable material

Chemical Compatibility																												
MATERIAL	CHEMICAL	Viton™	Tygon™	Titanium	Stainless Steel	Silicone Rubber	Rulon A™, Teflon™	Polyvynil Chloride	Polysulfone	Polypropylene	Polyethylene	Polythermide	Polyester, Glass Thermoset	Polycarbonate	Polyallomer	PET ¹ , Polyclear™, Clear Crimp™	Nylon	Noryl™	Neoprene	Glass	EPDM rubber	Delrin™	Composite Carbon Fiber/Epoxy	Polyurethane Rotor Paint	Cellulose Acetate Butyrate	Buna N	Anodic Coating for Aluminum	Aluminium
	AMMONIUM HYDROXIDE (CONC.)	U	S	S	S	S	S	M	S	S	S	S	U	U	S	U	S	S	S	S	S	S	U	S	U	U	U	U
	AMMONIUM PHOSPHATE	U	S	S	M	S	S	S	S	S	S	/	M	S	S	/	S	S	S	S	S	S	S	S	S	S	/	U
	AMMONIUM SULFATE	U	S	S	U	S	S	S	S	S	S	/	S	S	S	S	S	S	S	S	S	S	S	S	S	S	M	U
	AMYL ALCOHOL	S	/	S	/	U	/	/	/	M	S	S	S	S	M	/	S	S	/	M	/	S	S	/	/	U	S	S
	ANILINE	S	U	S	S	S	S	U	U	M	S	/	U	U	U	U	U	U	U	U	S	M	U	U	U	U	S	S
	SODIUM HYDROXIDE (<1%)	U	/	S	S	S	S	S	S	S	S	S	M	U	S	/	S	S	S	M	/	/	S	S	S	U	U	U
	SODIUM HYDROXIDE (10%)	U	/	S	S	S	S	S	S	S	S	S	U	U	S	U	U	S	S	M	/	/	S	S	S	U	U	U
	BARIUM SALTS	M	S	S	M	S	S	S	S	S	S	/	M	S	S	S	S	S	S	S	S	S	S	S	S	U	U	M
	BENZENE	S	U	S	U	U	U	U	U	U	M	U	M	U	U	U	U	S	U	U	S	U	U	U	U	U	S	S
	BENZYL ALCOHOL	S	/	S	/	S	/	/	/	U	U	U	U	U	U	U	S	S	/	M	/	S	S	S	S	S	S	S
	BORIC ACID	U	S	S	S	S	S	S	S	S	S	U	U	S	S	S	S	S	S	S	S	S	S	S	S	S	S	S
	CESIUM ACETATE	M	S	S	M	S	S	S	S	S	S	/	/	S	S	/	S	S	S	S	S	S	S	S	S	S	S	S
	CESIUM BROMIDE	M	S	S	M	S	S	S	S	S	S	/	/	S	S	/	S	S	S	S	S	S	S	S	S	S	S	S
	CESIUM CHLORIDE	M	S	S	M	S	S	S	S	S	S	/	/	S	S	/	S	S	S	S	S	S	S	S	S	S	S	S
	CESIUM FORMATE	M	S	S	M	S	S	S	S	S	S	/	/	S	S	/	S	S	S	S	S	S	S	S	S	S	S	S
	S	Satisfactory																										
	M	Moderate attack, may be satisfactory for use in centrifuge depending on length of exposure, speed involved, etc.; suggest testing under actual conditions of use																										
	U	Unsatisfactory, not recommended																										
	/	Performance unknown; suggest testing, using sample to avoid loss of valuable material																										

Chemical Compatibility																																	
CHEMICAL	MATERIAL																																
		Viton™	Tygon™	Titanium	Stainless Steel	Silicone Rubber	Rulon A™, Teflon™	Polyvnyl Chloride	Polysulfone	Polypropylene	Polyethylene	Polythermide	Polyester, Glass Thermoset	Polycarbonate	Polyallomer	PET ¹ , Polyclear™, Clear Crimp™	Nylon	Noryl™	Neoprene	Glass	EPDM rubber	Delrin™	Composite Carbon Fiber/Epoxy	Polyurethane Rotor Paint	Cellulose Acetate Butyrate	Buna N	Anodic Coating for Aluminum	Aluminium					
CESIUM IODIDE		S	S	S	M	S	S	S	S	S	/	/	S	S	S	S	S	S	S	S	/	S	S	S	S	S	S	S	S	S	S	S	
CESIUM SULFATE		S	S	S	M	S	S	S	S	S	/	/	S	S	S	S	S	S	S	S	/	S	S	S	S	S	S	S	S	S	S	S	
CHLOROFORM		S	M	S	U	S	U	U	M	S	U	U	U	M	S	S	S	S	S	S	U	U	U	S	S	S	S	S	S	S	S	S	
CHROMIC ACID (10%)		S	S	S	S	S	S	S	S	S	S	U	U	M	S	S	S	S	S	S	U	U	U	S	S	S	S	S	S	S	S	S	
CHROMIC ACID (50%)		S	/	S	M	S	/	U	S	S	/	/	U	U	U	U	U	U	U	U	U	U	U	U	U	U	U	U	U	U	U	U	
CRESOL MIXTURE		S	U	S	M	S	S	U	U	U	/	/	U	U	U	U	U	U	U	U	U	U	U	U	U	U	U	U	U	U	U	U	
CYCLOHEXANE		S	U	S	M	S	S	U	U	U	S	/	U	U	U	U	U	U	U	U	U	U	U	U	U	U	U	U	U	U	U	U	
DEOXYCHOLATE		S	S	S	S	S	S	S	S	S	/	/	U	U	U	U	U	U	U	U	U	U	U	U	U	U	U	U	U	U	U	U	
DISTILLED WATER		S	S	S	S	S	S	S	S	S	S	S	U	U	U	U	U	U	U	U	U	U	U	U	U	U	U	U	U	U	U	U	
DEXTRAN		S	S	S	M	S	S	U	U	U	S	/	U	U	U	U	U	U	U	U	U	U	U	U	U	U	U	U	U	U	U	U	
DIETHYL ETHER		S	S	S	S	S	S	U	U	U	U	U	U	U	U	U	U	U	U	U	U	U	U	U	U	U	U	U	U	U	U	U	
DIETHYL KETONE		S	U	S	S	S	S	U	U	U	U	U	U	U	U	U	U	U	U	U	U	U	U	U	U	U	U	U	U	U	U	U	
DIETHYLPYRO-CARBONATE		S	S	S	S	S	S	U	U	U	/	/	U	U	U	U	U	U	U	U	U	U	U	U	U	U	U	U	U	U	U	U	
DIMETHYLSULFOXIDE		S	S	S	S	S	S	U	U	U	S	/	U	U	U	U	U	U	U	U	U	U	U	U	U	U	U	U	U	U	U	U	
DIOXANE		S	M	S	M	S	S	U	U	U	U	U	U	U	U	U	U	U	U	U	U	U	U	U	U	U	U	U	U	U	U	U	
FERRIC CHLORIDE		S	S	S	U	S	S	U	U	U	/	/	U	U	U	U	U	U	U	U	U	U	U	U	U	U	U	U	U	U	U	U	U
S		Satisfactory																															
M		Moderate attack, may be satisfactory for use in centrifuge depending on length of exposure, speed involved, etc.; suggest testing under actual conditions of use																															
U		Unsatisfactory, not recommended																															
/		Performance unknown; suggest testing, using sample to avoid loss of valuable material																															

Chemical Compatibility																												
MATERIAL	CHEMICAL	Viton™	Tygon™	Titanium	Stainless Steel	Silicone Rubber	Rulon A™, Teflon™	Polyvynil Chloride	Polysulfone	Polypropylene	Polyethylene	Polythermide	Polyester, Glass Thermoset	Polycarbonate	Polyallomer	PET ¹ , Polyclear™, Clear Crimp™	Nylon	Noryl™	Neoprene	Glass	EPDM rubber	Delrin™	Composite Carbon Fiber/Epoxy	Polyurethane Rotor Paint	Cellulose Acetate Butyrate	Buna N	Anodic Coating for Aluminum	Aluminium
	ACETIC ACID (GLACIAL)	U	M	S	U	U	S	U	M	U	S	M	U	U	U	U	U	S	S	U	S	M	S	S	U	U	S	S
	ACETIC ACID (5%)	/	S	S	M	S	S	M	S	S	S	S	S	S	S	M	S	S	S	S	S	S	S	S	S	S	S	S
	ACETIC ACID (60%)	/	M	S	U	M	S	M	S	M	S	/	S	U	M	U	U	S	S	M	S	/	S	S	U	U	S	S
	ETHYL ACETATE	U	U	S	M	M	S	U	U	S	S	S	U	U	M	U	S	S	S	S	S	M	S	S	U	U	S	S
	ETHYL ALCOHOL (50%)	U	U	S	M	M	S	S	S	S	S	S	U	U	M	U	U	S	S	S	S	M	S	S	U	U	S	S
	ETHYL ALCOHOL (95%)	U	U	S	M	M	S	S	S	S	S	S	U	U	M	U	U	S	S	S	S	M	S	S	U	U	S	S
	ETHYLENE DICHLORIDE	/	S	S	/	U	S	U	/	U	U	U	U	U	U	U	U	U	U	U	/	S	S	/	U	U	S	S
	ETHYLENE GLYCOL	/	M	S	M	S	S	U	S	S	S	S	U	U	U	U	U	U	U	U	S	S	S	S	U	U	S	S
	ETHYLENE OXIDE VAPOR	/	M	S	M	S	S	U	S	S	S	/	U	U	U	U	U	U	U	U	S	S	S	S	U	U	S	S
	FICOLL-HYPAQUE™	/	S	S	S	S	S	U	S	S	S	S	U	U	U	U	U	U	U	U	S	S	S	S	U	U	S	S
	HYDROFLUORIC ACID (10%)	/	S	S	U	U	S	M	S	S	S	S	U	U	U	U	U	U	U	U	/	/	/	/	U	U	U	U
	HYDROFLUORIC ACID (50%)	/	S	S	U	U	S	M	S	S	S	S	U	U	U	U	U	U	U	U	/	/	/	/	U	U	U	U
	HYDROCHLORIC ACID (CONC.)	/	S	S	U	U	S	M	S	S	S	S	U	U	U	U	U	U	U	U	/	/	/	/	U	U	U	U
	FORMALDEHYDE (40%)	/	M	S	S	S	S	U	M	S	S	U	U	U	U	U	U	U	U	U	/	/	/	/	U	U	U	U
		S	S	S	S	S	S	S	S	S	S	S	S	S	S	S	S	S	S	S	S	S	S	S	S	S	S	S
		Satisfactory																										
		Moderate attack, may be satisfactory for use in centrifuge depending on length of exposure, speed involved, etc.; suggest testing under actual conditions of use																										
		Unsatisfactory, not recommended																										
		Performance unknown; suggest testing, using sample to avoid loss of valuable material																										

Chemical Compatibility											
CHEMICAL	MATERIAL										
		GLUTARALDEHYDE	S	M	U	S	S	/	M	M	S
GLYCEROL	U	S	/	S	S	/	S	S	S	S	S
GUANIDINE HYDROCHLORIDE	S	S	/	S	S	/	S	S	S	S	S
HAEMO-SOL™	S	S	/	S	S	/	S	S	S	S	S
HEXANE	/	M	U	S	S	/	S	S	S	S	S
ISOBUTYL ALCOHOL	M	M	U	S	S	/	S	S	S	S	S
ISOPROPYL ALCOHOL	S	M	/	S	S	/	S	S	S	S	S
IODOACETIC ACID	U	S	/	S	S	/	S	S	S	S	S
POTASSIUM BROMIDE	M	U	S	S	S	/	S	S	S	S	S
POTASSIUM CARBONATE	U	S	/	S	S	/	S	S	S	S	S
POTASSIUM CHLORIDE	U	S	/	S	S	/	S	S	S	S	S
POTASSIUM HYDROXIDE (5%)	U	S	S	S	S	/	S	S	S	S	S
POTASSIUM HYDROXIDE (CONC.)	U	M	U	S	S	/	S	S	S	S	S
POTASSIUM PERMANGANATE	S	S	/	S	S	/	S	S	S	S	S
S	Satisfactory										
M	Moderate attack, may be satisfactory for use in centrifuge depending on length of exposure, speed involved, etc.; suggest testing under actual conditions of use										
U	Unsatisfactory, not recommended										
/	Performance unknown; suggest testing, using sample to avoid loss of valuable material										

Chemical Compatibility			
MATERIAL	CHEMICAL		
		Viton™	S
Tygon™	S	/	S
Titanium	S	S	S
Stainless Steel	M	U	S
Silicone Rubber	S	M	U
Rulon A™, Teflon™	S	S	S
Polyvynil Chloride	S	M	S
Polysulfone	S	S	M
Polypropylene	S	S	M
Polyethylene	S	S	M
Polythermide	/	/	/
Polyester, Glass Thermoset	S	S	S
Polycarbonate	M	M	M
Polyallomer	S	S	M
PET ¹ , Polyclear™, Clear Crimp™	S	/	U
Nylon	S	S	S
Noryl™	S	/	U
Neoprene	S	M	M
Glass	S	/	S
EPDM rubber	S	S	U
Delrin™	S	M	S
Composite Carbon Fiber/Epoxy	S	M	S
Polyurethane Rotor Paint	S	S	S
Cellulose Acetate Butyrate	S	/	/
Buna N	S	U	S
Anodic Coating for Aluminum	U	/	S
Aluminium	M	/	U
	CALCIUM CHLORIDE	M	U
	CALCIUM HYPOCHLORITE	M	/
	KEROSENE	S	/
	SODIUM CHLORIDE (10%)	S	S
	SODIUM CHLORIDE (sat'd)	U	/
	CARBON TETRACHLORIDE	U	U
	AQUA REGIA	U	/
	SOLUTION 555 (20%)	S	S
	MAGNESIUM CHLORIDE	M	/
	MERCAPTOACETIC ACID	U	S
	METHYL ALCOHOL	S	U
	METHYLENE CHLORIDE	U	U
	METHYL ETHYL KETONE	S	U
	METIZAMIDE™	M	S
	LACTIC ACID (100%)	/	/
	LACTIC ACID (20%)	/	/
	S	Satisfactory	
	M	Moderate attack, may be satisfactory for use in centrifuge depending on length of exposure, speed involved, etc.; suggest testing under actual conditions of use	
	U	Unsatisfactory, not recommended	
	/	Performance unknown; suggest testing, using sample to avoid loss of valuable material	

Chemical Compatibility															
MATERIAL	CHEMICAL														
		Viton™	S	S	S	S	S	S	S	S	S	S	S	S	S
Tygon™	/	U	S	S	S	S	S	S	S	M	S	S	S	S	S
Titanium	S	S	S	S	S	S	S	S	S	S	S	S	S	S	S
Stainless Steel	/	M	S	M	M	M	S	S	S	U	M	S	M	S	S
Silicone Rubber	M	M	M	M	S	S	S	S	S	M	S	U	S	S	U
Rulon A™, Teflon™	S	S	S	S	S	S	S	S	S	S	S	S	S	S	S
Polyvynil Chloride	M	U	U	S	S	S	S	S	S	S	S	S	/	S	S
Polysulfone	M	S	U	S	S	S	S	S	S	S	S	S	/	S	S
Polypropylene	S	U	S	S	S	S	S	S	S	M	S	S	S	S	U
Polyethylene	S	U	S	S	S	S	S	S	S	S	S	S	/	S	U
Polythermide	S	/	/	/	/	S	S	S	S	S	/	/	/	/	M
Polyester, Glass Thermoset	S	M	U	S	S	S	/	S	S	/	S	S	U	M	S
Polycarbonate	M	U	U	S	S	U	S	S	S	S	S	S	U	S	M
Polyallomer	S	U	S	S	S	S	S	S	M	S	S	S	S	S	U
PET ¹ , Polyclear™, Clear Crimp™	U	U	U	S	S	S	S	S	S	S	S	S	S	S	U
Nylon	/	S	S	U	S	S	S	S	S	S	S	S	S	/	S
Noryl™	M	U	U	S	S	S	S	S	S	S	S	S	/	S	S
Neoprene	S	U	S	S	S	S	S	S	M	S	S	S	/	S	S
Glass	/	S	S	S	S	S	S	S	S	S	S	S	/	M	S
EPDM rubber	/	/	/	S	/	S	/	S	S	/	S	S	S	/	U
Delrin™	S	S	S	S	S	S	S	S	U	S	S	S	/	S	S
Composite Carbon Fiber/Epoxy	/	S	M	S	S	S	S	S	M	S	S	S	/	/	/
Polyurethane Rotor Paint	/	S	S	S	S	S	S	S	S	S	S	/	/	/	/
Cellulose Acetate Butyrate	U	/	U	S	/	S	/	S	S	/	/	S	/	S	/
Buna N	S	U	S	S	S	S	S	S	M	S	S	S	S	S	S
Anodic Coating for Aluminum	/	S	S	S	S	U	S	S	U	S	S	S	/	S	S
Aluminium	S	S	S	M	U	M	S	S	U	M	M	S	U	S	S
S	Satisfactory														
M	Moderate attack, may be satisfactory for use in centrifuge depending on length of exposure, speed involved, etc.; suggest testing under actual conditions of use														
U	Unsatisfactory, not recommended														
/	Performance unknown; suggest testing, using sample to avoid loss of valuable material														

Chemical Compatibility	
MATERIAL	CHEMICAL
Viton™	S M S S
Tygon™	M M S / S U M S
Titanium	S S M S S U M M S S
Stainless Steel	S U U / U M U M S M S
Silicone Rubber	/ M S U U U U S U M S S
Rulon A™, Teflon™	S S S S S S S S S S S S S S
Polyvynil Chloride	S S S M M U U S M S S S S
Polysulfone	S S S / U U U S S S M S S
Polypropylene	S S S M M S M S S S S S S
Polyethylene	U S S M M M U S S S S S S S
Polythermide	S S S S U S S S S S S S S S
Polyester, Glass Thermoset	S S S M U M U S S S S S S S
Polycarbonate	S S U U U U U S M S S S U S S
Polyallomer	S S S M M S U S M S S S S S S
PET ¹ , Polyclear™, Clear Crimp™	U M U / U U U / U S S S S S
Nylon	S S S / U U U U U S U S S S
Noryl™	S S S M M M M S S M S S S S
Neoprene	S U S M U U U S S M S M S S S
Glass	S S S S S S S / S S S U S S S
EPDM rubber	M U S / / / S / S S S S S S
Delrin™	S U U U U M M U U S / S S S S S
Composite Carbon Fiber/Epoxy	/ S S U U M U S / M S S S S S
Polyurethane Rotor Paint	/ S S S / S S S / S S S S S S
Cellulose Acetate Butyrate	/ S S / / / S / / S / S / S
Buna N	S U M U U U U M M S S U U S U S S S
Anodic Coating for Aluminum	/ / U / U S S U U M S S S U S S S
Aluminium	S S U U U U U M S S S U S S S S
OILS (OTHER)	S M S S
OLEIC ACID	S M S S
OXALIC ACID	U M S S
PERCHLORIC ACID (10%)	U / U U U S S U U S S S
PERCHLORIC ACID (70%)	U / U U U S S U U S S S S
PHENOL (5%)	U S U U U M M S S S S S S
PHENOL (50%)	U S U U U M M S S S S S S S
PHOSPHORIC ACID (10%)	U U M M S S U U M S S S S S
PHOSPHORIC ACID (conc.)	U U M M S S U U M S S S S S
PHYSIOLOGIC MEDIA (SERUM, URINE)	M S S S S S S S S S S S S S
PICRIC ACID	S S S S S S S S S S S S S S
PYRIDINE (50%)	U S U S S S S S S S S S S S
RUBIDIUM BROMIDE	M S S S S S S S S S S S S S
RUBIDIUM CHLORIDE	M S S S S S S S S S S S S S
SUCROSE	M S S S S S S S S S S S S S
S	Satisfactory
M	Moderate attack, may be satisfactory for use in centrifuge depending on length of exposure, speed involved, etc.; suggest testing under actual conditions of use
U	Unsatisfactory, not recommended
/	Performance unknown; suggest testing, using sample to avoid loss of valuable material

Chemical Compatibility																												
CHEMICAL	MATERIAL																											
		Viton™	Tygon™	Titanium	Stainless Steel	Silicone Rubber	Rulon A™, Teflon™	Polyvynil Chloride	Polysulfone	Polypropylene	Polyethylene	Polythermide	Polyester, Glass Thermoset	Polycarbonate	Polyallomer	PET ¹ , Polyclear™, Clear Crimp™	Nylon	Noryl™	Neoprene	Glass	EPDM rubber	Delrin™	Composite Carbon Fiber/Epoxy	Polyurethane Rotor Paint	Cellulose Acetate Butyrate	Buna N	Anodic Coating for Aluminum	Aluminium
SUCROSE, ALKALINE		S	S	S	M	S	S	S	S	S	S	S	U	U	S	S	S	S	S	S	/	S	S	S	S	S	S	M
SULFOSALICYLIC ACID		S	S	S	U	S	S	/	S	S	S	S	S	S	S	S	S	S	S	S	S	/	S	S	S	S	S	U
NITRIC ACID (10%)		S	S	S	S	S	S	S	S	S	S	S	S	S	S	S	S	S	S	S	S	/	S	S	S	S	S	U
NITRIC ACID (50%)		S	S	S	S	S	S	S	S	S	S	S	S	S	S	S	S	S	S	S	S	/	S	S	S	S	S	U
NITRIC ACID (95%)		S	S	S	S	S	S	S	S	S	S	S	S	S	S	S	S	S	S	S	S	/	S	S	S	S	S	U
HYDROCHLORIC ACID (10%)		S	S	S	U	S	S	S	S	S	S	S	S	S	S	S	S	S	S	S	S	/	S	S	S	S	S	U
HYDROCHLORIC ACID (50%)		S	S	S	U	S	S	S	S	S	S	S	S	S	S	S	S	S	S	S	S	/	S	S	S	S	S	U
SULFURIC ACID (10%)		S	S	S	U	S	S	S	S	S	S	S	S	S	S	S	S	S	S	S	S	/	S	S	S	S	S	U
SULFURIC ACID (50%)		S	S	S	U	S	S	S	S	S	S	S	S	S	S	S	S	S	S	S	S	/	S	S	S	S	S	U
SULFURIC ACID (conc.)		S	S	S	U	S	S	S	S	S	S	S	S	S	S	S	S	S	S	S	S	/	S	S	S	S	S	U
STEARIC ACID		S	S	S	S	S	S	S	S	S	S	S	S	S	S	S	S	S	S	S	S	/	S	S	S	S	S	U
TETRAHYDROFURAN		S	S	S	S	S	S	S	S	S	S	S	S	S	S	S	S	S	S	S	S	/	S	S	S	S	S	U
TOLUENE		S	S	S	S	S	S	S	S	S	S	S	S	S	S	S	S	S	S	S	S	/	S	S	S	S	S	U
TRICHLOROACETIC ACID		S	S	S	S	S	S	S	S	S	S	S	S	S	S	S	S	S	S	S	S	/	S	S	S	S	S	U
S		Satisfactory																										
M		Moderate attack, may be satisfactory for use in centrifuge depending on length of exposure, speed involved, etc.; suggest testing under actual conditions of use																										
U		Unsatisfactory, not recommended																										
/		Performance unknown; suggest testing, using sample to avoid loss of valuable material																										

Chemical Compatibility																									
CHEMICAL	MATERIAL																								
		TRICHLOROETHANE	S	/	U	/	/	/	/	U	/	/	S												
TRICHLOROETHYLENE	/	/	U	/	/	/	/	U	/	/	S														
TRISODIUM PHOSPHATE	/	/	/	/	/	/	/	U	/	/	S														
TRIS BUFFER (NEUTRAL PH)	U	S	S	S	S	S	S	U	S	S	S														
TRITON X/100™	S	S	S	/	S	S	S	U	S	S	S														
UREA	S	/	U	S	S	S	S	U	S	S	S														
HYDROGEN PEROXIDE (10%)	U	U	M	S	S	S	S	U	S	S	S														
HYDROGEN PEROXIDE (3%)	S	M	S	S	S	S	S	U	S	S	S														
XYLENE	S	S	U	S	S	S	S	U	S	S	S														
ZINC CHLORIDE	U	U	S	S	S	S	S	U	S	S	S														
ZINC SULFATE	U	S	S	/	S	S	S	U	S	S	S														
CITRIC ACID (10%)	M	S	S	M	S	S	S	U	S	S	S														
S	Satisfactory																								
M	Moderate attack, may be satisfactory for use in centrifuge depending on length of exposure, speed involved, etc.; suggest testing under actual conditions of use																								
U	Unsatisfactory, not recommended																								
/	Performance unknown; suggest testing, using sample to avoid loss of valuable material																								
		Aluminium	Polyurethane Rotor Paint	Composite Carbon Fiber/Epoxy	Delrin™	EPDM rubber	Glass	Neoprene	Noryl™	Nylon	PET ¹ , Polyclear™, Clear Crimp™	Polyallomer	Polycarbonate	Polyester, Glass Thermoset	Polythermide	Polyethylene	Polypropylene	Polysulfone	Polyvinyl Chloride	Rulon A™, Teflon™	Silicone Rubber	Stainless Steel	Titanium	Tygon™	Viton™
		S	/	/	M	U	/	U	/	S	U	S	U	U	U	U	U	U	S	S	U	/	S	/	S

¹ Polyethyleneterephthalate

NOTICE Chemical resistance data is included only as a guide to product use. Because no organized chemical compatibility data exists for materials under the stress of centrifugation, when in doubt we recommend pretesting sample lots.

Index

8 x 50 mL Sealed B-25

A

Acceleration and Deceleration Profiles 2-11
Acceleration Profile 3-3
Aerosol-Tightness
 Basic Principles 2-13
 Fill Level 2-13
Aerosol-Tight Rotor Buckets 2-13
Aerosol-Tight Rotor Lids 2-13
Autoclaving 4-5

B

Balanced Loading 2-7
Basics 4-1
Before loading a Rotor 2-8
BIOShield 720 B-19
BIOShield 1000A B-21

C

Centrifugation 2-12
Centrifugation (LCD Models) 3-6
Checking the Aerosol-Tightness 2-14
Chemical Compatibility C-1
Cleaning 4-2
Cleaning Intervals 4-1
CLINIConic B-23
Continuous Mode Operation 3-6
Correct Loading 2-8
Cycles of Rotors and Buckets 4-2

D

Deceleration Profiles (LCD Models) 3-4
Decontamination 4-4
Directives, Standards and Guidelines A-4
Disinfection 4-4
Disposal 4-6

E

Ethernet 1-10

F

Fiberlite F10-6 x 100 LEX B-41
Fiberlite F15-6 x 100y B-37
Fiberlite F21-48 x 2 B-39

H

Handling Error Messages 3-7
H-FLEX 1 B-13
H-FLEX HS4 B-15
HIGHConic II B-27
How to Install and Remove a Rotor 2-5

I

Ice Formation 5-2
Identify Rotor and Buckets 2-10
Incorrect Loading 2-8
Information about my Centrifuge vii

Information for the Customer Service 5-3
Initial Startup 1-10
Install and Remove a Rotor 2-5
Intended Use vii
Intended Use for IVD Centrifuges vii
Intended Use for Laboratory Use Centrifuges vii
Intended User viii
Items Supplied vii, 1-1

L

LCD Control Panel 3-1
 Overview 3-1
Load the Rotor 2-7
Location 1-1

M

M-20 Microplate B-17
Mains Connection 1-10
Mains Supply A-7
Maintenance and Care 4-1
Maximum Loading 2-9
Mechanical Emergency Door Release 5-1
Metal Parts 4-1
MicroClick 18 x 5 B-35
MicroClick 30 x 2 B-33, B-34
Microliter 30 x 2 B-29
Microliter 48 x 2 B-31

O

Open/Close the Centrifuge Lid 2-4
Operation 2-1

P

Plastic Parts 4-2
Position of parts 2-1
Power on/off the Centrifuge 2-4
Preface vii
Pre-Temper the Centrifugation Chamber 2-11
Pre-Temper the Centrifugation Chamber (LCD Models) 3-4
Product Overview 1-7
Program Mode Operation 3-7
Programs 3-6

R

Refrigerants A-6
Rotor and Accessories Inspection 4-1
Rotor Program A-8
Rotors for Laboratory Use Centrifuges A-8
Rotor Specifications B-1
RS232 1-10

S

Safety Instructions x
Select the Bucket Type 3-5
Service 4-6
Set Basic Centrifugation Parameters 2-11
Set Basic Centrifugation Parameters (LCD Models) 3-2
Set Run Time 2-11, 3-3
Set Speed / RCF-Value 2-11, 3-2
Set Temperature 2-11

Set Temperature (LCD Models) 3-5
Setting Up and Saving a Program (LCD Models)
3-6
Shipping 4-6
Signal Words and Symbols viii
Slide Coated Rotors 4-1
SL Plus Series A-1
Stop an Ongoing Centrifugation Run 3-7
Storage 4-6
Symbols used in the Instructions for Use ix
Symbols used on Unit and Accessories viii
System Menu 3-8

T

Technical Specifications A-1
Timed Mode Operation 3-7
Touchscreen 4-3
Transport and Set Up 1-1
Transporting 1-2
Troubleshooting 5-1
Troubleshooting by Guide 5-2
TX-200 B-2
TX-400 B-4
TX-750 B-6
TX-1000 B-11

U

Unpacking 1-1
USB 1-10
Use of Tubes and Consumables 2-10

V

Ventilation Grid 4-3



Thermo Electron LED GmbH
Zweigniederlassung Osterode
Am Kalkberg, 37520 Osterode am Harz
Germany



thermofisher.com/centrifuge

© 2019-2021 Thermo Fisher Scientific Inc. All rights reserved.
All trademarks are the property of Thermo Fisher Scientific Inc. and its subsidiaries unless otherwise indicated.

Delrin is a registered trademark of Dupont Polymers, Inc. TEFLON and Viton are registered trademarks of The Chemours Company FC. Noryl and Valox are registered trademarks of Sabic Global Technologies. POLYCLEAR is a registered trademark of Hongye CO., Ltd. Hypaque is a registered trademark of Amersham Health AS. RULON A and Tygon are registered trademarks of Saint-Gobain Performance Plastics. Alconox is a registered trademark of Alconox, Inc. Ficoll is a registered trademark of Cytiva Sweden AB. Haemo-Sol is a registered trademark of Haemo-Sol International, LLC. Triton is a registered trademark of Union Carbide Corporation.

Specifications, terms and pricing are subject to change. Not all products are available in all countries. Please consult your local sales representative for details.

Shown pictures within the manual are examples and may differ considering the set parameters and language. Pictures of the user interface within the manual are showing the English version as example.

Australia +61 39757 4300

Austria +43 1 801 40 0

Belgium +32 9 272 54 82

China +800 810 5118, +400 650 5118

France +33 2 2803 2180

Germany national toll free

0800 1 536 376

Germany international +49 6184 90 6000

India toll free +1800 22 8374

India +91 22 6716 2200

Italy +39 02 95059 552

Japan +81 3 5826 1616

Korea +82 2 2023 0600

Netherlands +31 76 579 55 55

New Zealand +64 9 980 6700

Nordic/Baltic/CIS countries

+358 10 329 2200

Russia +7 812 703 42 15, +7 495 739 76 41

Singapore +82 2 3420 8700

Spain/Portugal +34 93 223 09 18

Switzerland +41 44 454 12 12

UK/Ireland +44 870 609 9203

USA/Canada +1 866 984 3766

Other Asian Countries +852 3107 7600

Countries not listed +49 6184 90 6000

en

